



Chipsmall Limited consists of a professional team with an average of over 10 year of expertise in the distribution of electronic components. Based in Hongkong, we have already established firm and mutual-benefit business relationships with customers from,Europe,America and south Asia,supplying obsolete and hard-to-find components to meet their specific needs.

With the principle of "Quality Parts,Customers Priority,Honest Operation,and Considerate Service",our business mainly focus on the distribution of electronic components. Line cards we deal with include Microchip,ALPS,ROHM,Xilinx,Pulse,ON,Everlight and Freescale. Main products comprise IC,Modules,Potentiometer,IC Socket,Relay,Connector.Our parts cover such applications as commercial,industrial, and automotives areas.

We are looking forward to setting up business relationship with you and hope to provide you with the best service and solution. Let us make a better world for our industry!



Contact us

Tel: +86-755-8981 8866 Fax: +86-755-8427 6832

Email & Skype: info@chipsmall.com Web: www.chipsmall.com

Address: A1208, Overseas Decoration Building, #122 Zhenhua RD., Futian, Shenzhen, China



CKT SIZE	① HOUSING	② TPA	③ POWER TERMINAL	④ SIGNAL TERMINAL	⑤ SIGNAL HOUSING (3 OF EA REQ'D)	DIMENSION 'A'	DIMENSION 'B'	DIMENSION 'C'	DIMENSION 'D'	DIMENSION 'E'
	MATERIAL: PBT, FILLED	MATERIAL: PBT, FILLED	MATERIAL: COPPER ALLOY FINISH: TIN OVER NICKEL W/SELECT GOLD	MATERIAL: PHOS. BRONZE FINISH: TIN OVER NICKEL W/SELECT GOLD	MATERIAL: NYLON, UNFILLED					
2P-12S	172512-3212	46708-3212	173693-****	70058-****	46709-0004	63.81	55.01	26.48	12.37	43.74
2P-18S	172512-3218	46708-3218	173693-****	70058-****	46709-0006	68.89	60.09	31.80	17.44	48.82
2P-24S	172512-3224	46708-3224	173693-****	70058-****	46709-0008	73.97	65.17	36.85	22.53	53.90
4P-12S	172512-3412	46708-3412	173693-****	70058-****	46709-0004	78.81	70.01	41.48	12.37	58.74
4P-18S	172512-3418	46708-3418	173693-****	70058-****	46709-0006	83.89	75.09	46.80	17.44	63.82
4P-24S	172512-3424	46708-3424	173693-****	70058-****	46709-0008	88.97	80.17	51.85	22.53	68.90
6P-12S	172512-3612	46708-3612	173693-****	70058-****	46709-0004	93.81	85.01	55.73	12.37	73.74
6P-18S	172512-3618	46708-3618	173693-****	70058-****	46709-0006	98.89	90.09	61.85	17.44	78.82
6P-24S	172512-3624	46708-3624	173693-****	70058-****	46709-0008	103.97	95.17	66.93	22.53	83.90

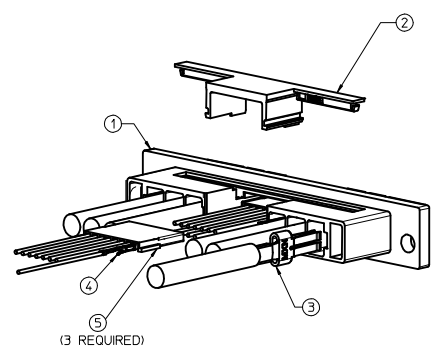

EXPLODED VIEW

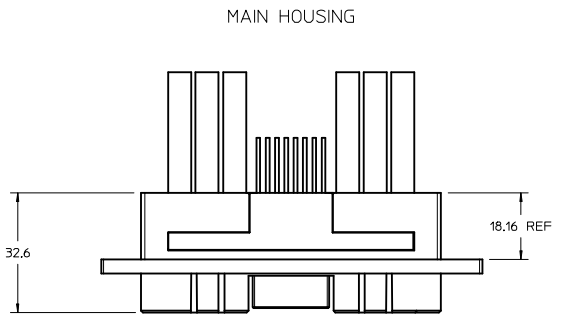

MAIN HOUSING

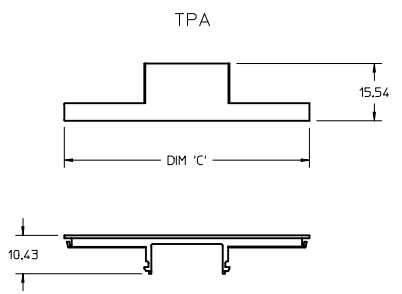

TPA

SIGNAL HOUSING

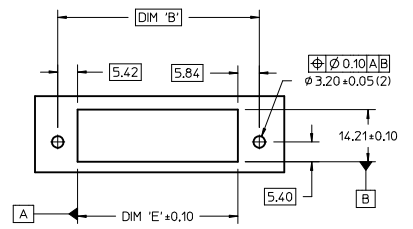
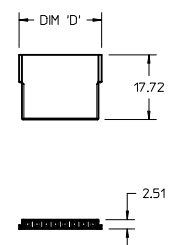

PANEL CUTOUT
(FRONT VIEW)

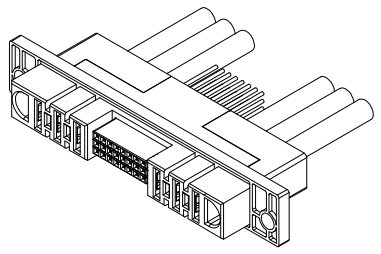
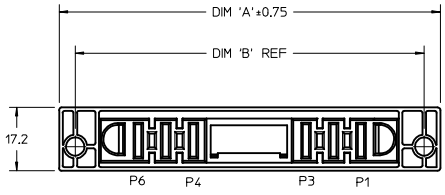

NOTES:

- SEE CHART FOR MATERIAL DETAILS
- PART MATES TO MOLEX PLUG SERIES 172458.
- ASSEMBLY SHOWN FOR REFERENCE ONLY. EACH ITEM HAS TO BE ORDERED SEPARATELY.
- PANEL MOUNTING HARDWARE: (2) M3 X 0.5 X 4.00 LG PRECISION SHOULDER SCREWS AND (2) M3 X 0.5 HEX NUTS TO BE PURCHASED SEPARATELY BY CUSTOMER.
- SEE SD-173693-001 FOR POWER TERMINAL DETAILS.
- SEE SD-70058-*** FOR SIGNAL TERMINAL DETAILS.

CHG TRMNL P/N EC NO: UCP2016-4071 DRAWN: JSCHAER 2016/04/18 CHKD: APPR: BPISZCZOR 2016/10/03	QUALITY SYMBOLS	GENERAL TOLERANCES (UNLESS SPECIFIED)	DIMENSION STYLE	SCALE	DESIGN UNITS	THIRD ANGLE PROJECTION																		
	$\nabla=0$ $\nabla=0$ $\nabla=0$	<table border="1"> <tr> <th></th> <th>mm</th> <th>INCH</th> </tr> <tr> <td>4 PLACES</td> <td>±---</td> <td>±---</td> </tr> <tr> <td>3 PLACES</td> <td>±---</td> <td>±---</td> </tr> <tr> <td>2 PLACES</td> <td>±0.13</td> <td>±---</td> </tr> <tr> <td>1 PLACE</td> <td>±0.25</td> <td>±---</td> </tr> <tr> <td>0 PLACE</td> <td>±---</td> <td>±---</td> </tr> </table>		mm	INCH	4 PLACES	±---	±---	3 PLACES	±---	±---	2 PLACES	±0.13	±---	1 PLACE	±0.25	±---	0 PLACE	±---	±---	MM ONLY	1.5:1	METRIC	
		mm	INCH																					
	4 PLACES	±---	±---																					
3 PLACES	±---	±---																						
2 PLACES	±0.13	±---																						
1 PLACE	±0.25	±---																						
0 PLACE	±---	±---																						
DESCRIPTION	APPROVED BY	DATE	TITLE	TEN60 RECEIPT ASSY POWER/SIGNAL MIXED PANEL-TO-BOARD molex																				
	BPISZCZOR	2016/10/03																						
	DRAFT WHERE APPLICABLE MUST REMAIN WITHIN DIMENSIONS		MATERIAL NO.	DOCUMENT NO.	SHEET NO.																			
			SEE CHART	SD-172512-001	1 OF 1																			
THIS DRAWING CONTAINS INFORMATION THAT IS PROPRIETARY TO MOLEX INCORPORATED AND SHOULD NOT BE USED WITHOUT WRITTEN PERMISSION																								