



Chipsmall Limited consists of a professional team with an average of over 10 year of expertise in the distribution of electronic components. Based in Hongkong, we have already established firm and mutual-benefit business relationships with customers from,Europe,America and south Asia,supplying obsolete and hard-to-find components to meet their specific needs.

With the principle of “Quality Parts,Customers Priority,Honest Operation,and Considerate Service”,our business mainly focus on the distribution of electronic components. Line cards we deal with include Microchip,ALPS,ROHM,Xilinx,Pulse,ON,Everlight and Freescale. Main products comprise IC,Modules,Potentiometer,IC Socket,Relay,Connector.Our parts cover such applications as commercial,industrial, and automotives areas.

We are looking forward to setting up business relationship with you and hope to provide you with the best service and solution. Let us make a better world for our industry!



Contact us

Tel: +86-755-8981 8866 Fax: +86-755-8427 6832

Email & Skype: info@chipsmall.com Web: www.chipsmall.com

Address: A1208, Overseas Decoration Building, #122 Zhenhua RD., Futian, Shenzhen, China



Alle Rechte vorbehalten/ All rights reserved

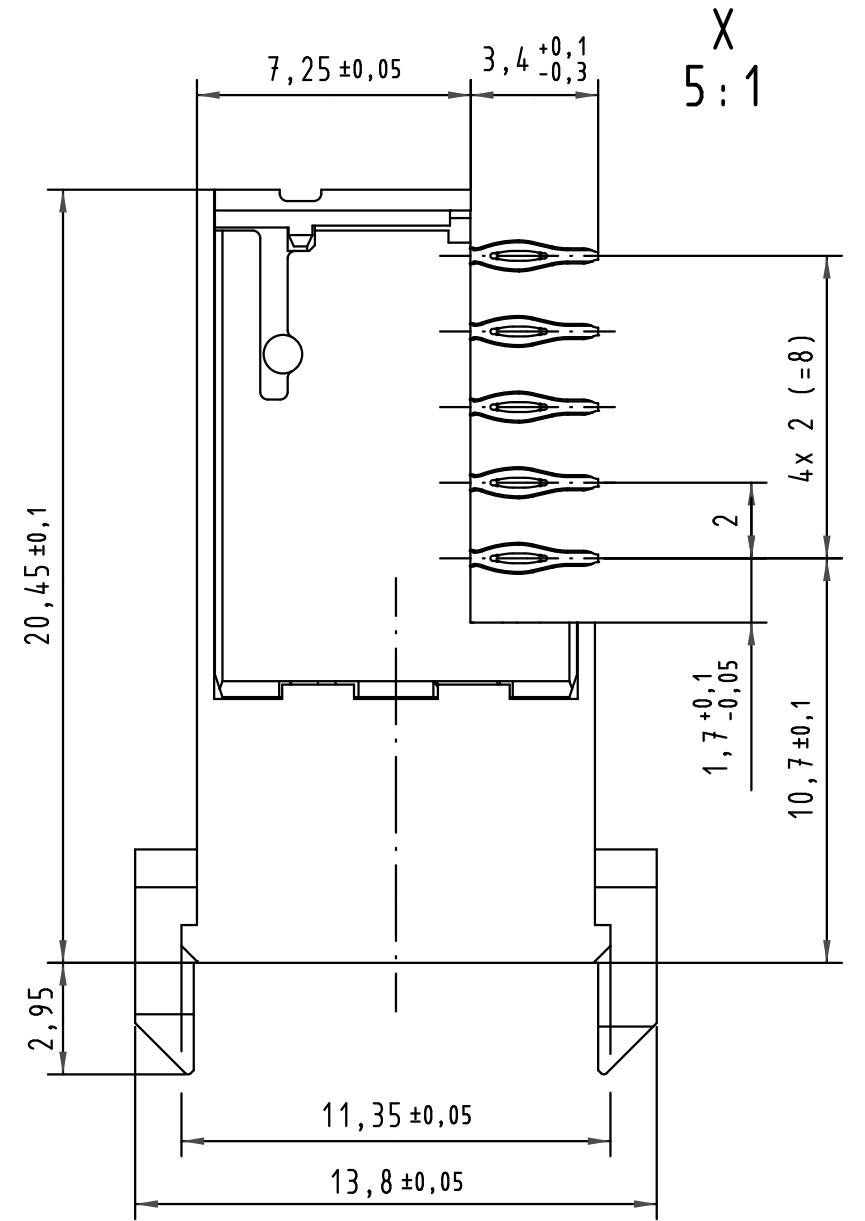
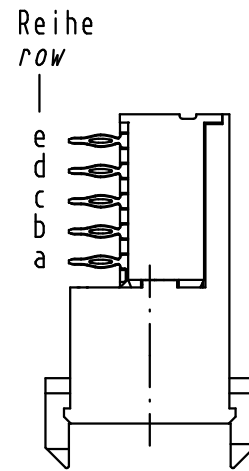
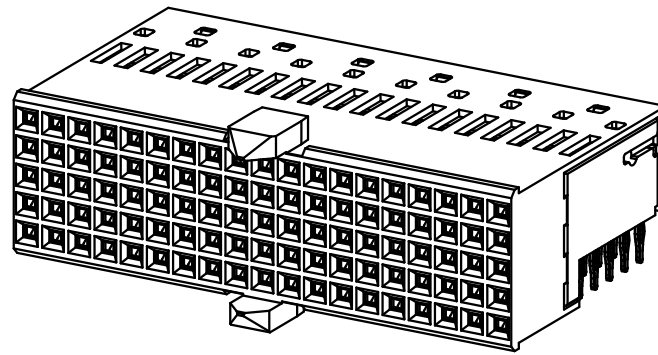
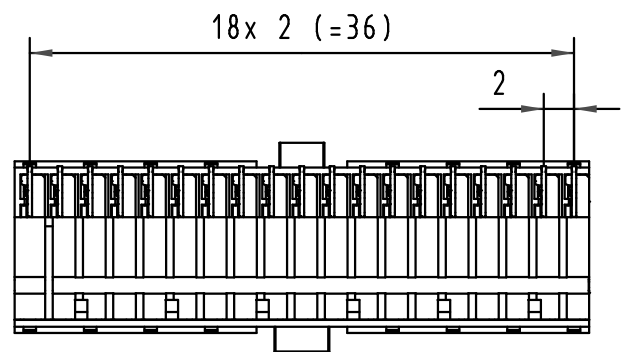
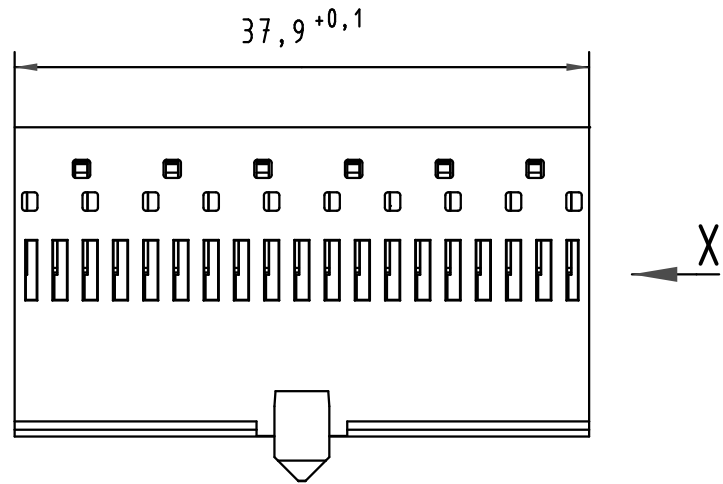
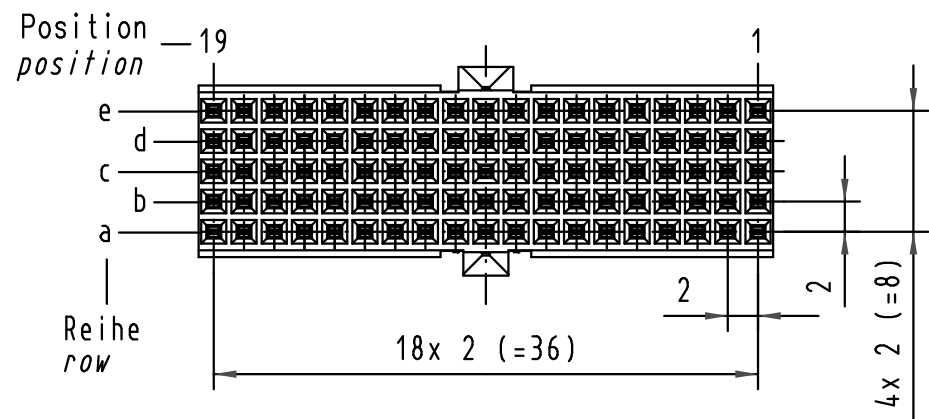

**Lochbild
board drillings**

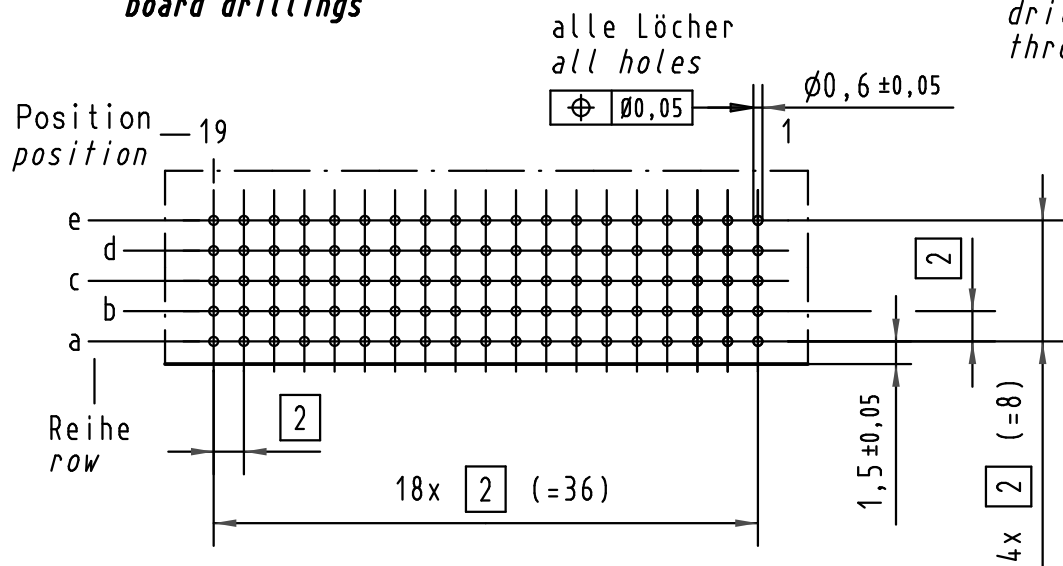

Bohrlochdurchmesser: $\phi 0,7 \pm 0,02$ mm
 Lochdurchmesser (mit Oberfläche): $\phi 0,6 \pm 0,05$ mm
 drill hole dia.: $\phi 0,7 \pm 0,02$ mm
 through hole dia. (after plating): $\phi 0,6 \pm 0,05$ mm

17 33 095 <u>4</u> 101	—	min. 0,76 μ m (30 μ m) Au über/over min. 1,27 μ m (50 μ m) Ni
17 33 095 <u>2</u> 101	2	Au über/over Ni
17 33 095 <u>1</u> 101	1	Au über/over Ni
Bestell-Nr. part-no.	Anforderungsstufe nach IEC performance level acc. to IEC	Kontaktoberfläche contact plating

All Dimensions in mm Original Size DIN A 3		Techn. Character.		Nicht tolerierte Maß/Free size tolerances IEC 61076-4-101	
		Dat.	Name	Maßstab/Scale	
		Detail.	01.06.01 Hm	2:1 5:1	
		Insp.	01.06.01 Ko		
		Stand.			
34650	04.02.08 Hage.	HARTING Electronics GmbH & Co. KG		TB 17 33 095 x101 Blatt/page	
27619		D-32339 ESPELKAMP			
Mod.	Dat.	Name		Sub.	