



Chipsmall Limited consists of a professional team with an average of over 10 year of expertise in the distribution of electronic components. Based in Hongkong, we have already established firm and mutual-benefit business relationships with customers from,Europe,America and south Asia,supplying obsolete and hard-to-find components to meet their specific needs.

With the principle of "Quality Parts,Customers Priority,Honest Operation,and Considerate Service",our business mainly focus on the distribution of electronic components. Line cards we deal with include Microchip,ALPS,ROHM,Xilinx,Pulse,ON,Everlight and Freescale. Main products comprise IC,Modules,Potentiometer,IC Socket,Relay,Connector.Our parts cover such applications as commercial,industrial, and automotives areas.

We are looking forward to setting up business relationship with you and hope to provide you with the best service and solution. Let us make a better world for our industry!



Contact us

Tel: +86-755-8981 8866 Fax: +86-755-8427 6832

Email & Skype: info@chipsmall.com Web: www.chipsmall.com

Address: A1208, Overseas Decoration Building, #122 Zhenhua RD., Futian, Shenzhen, China



Alle Rechte vorbehalten! All rights reserved

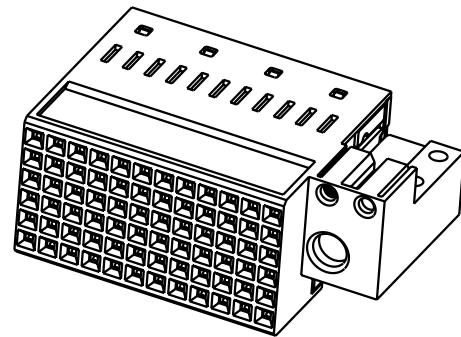
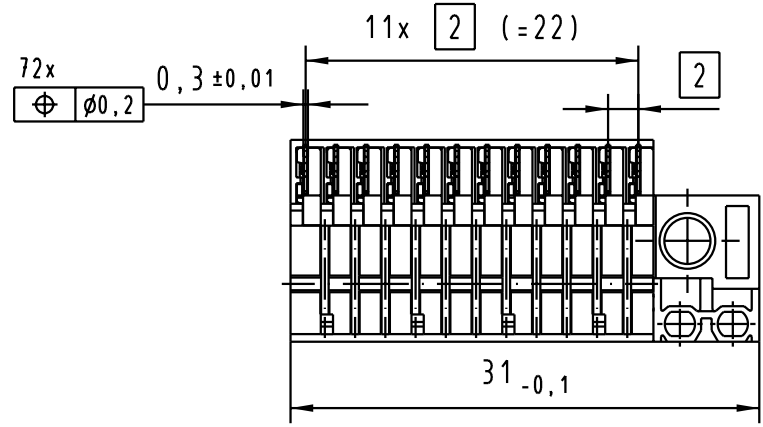
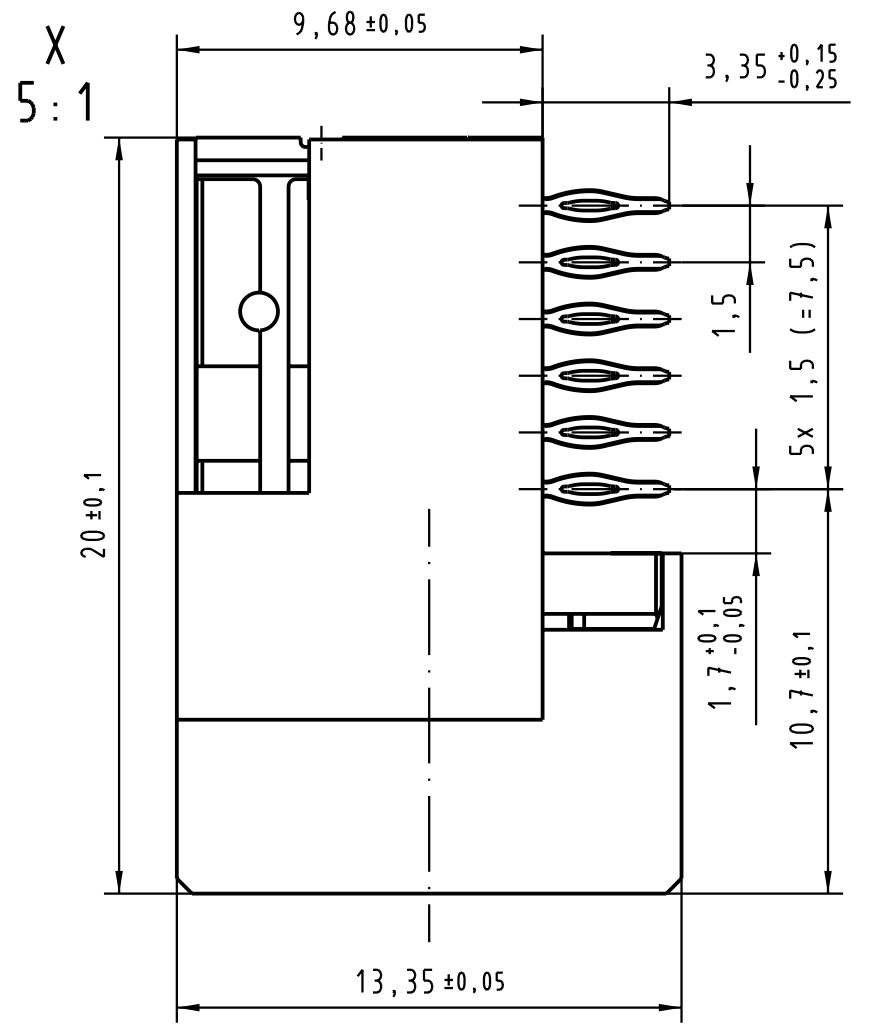
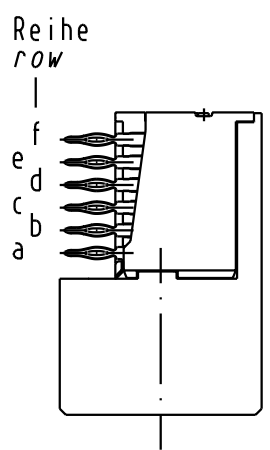
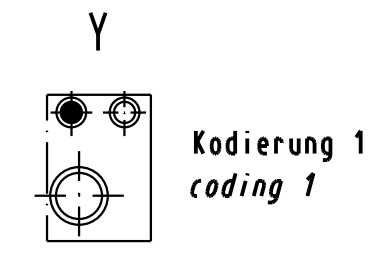
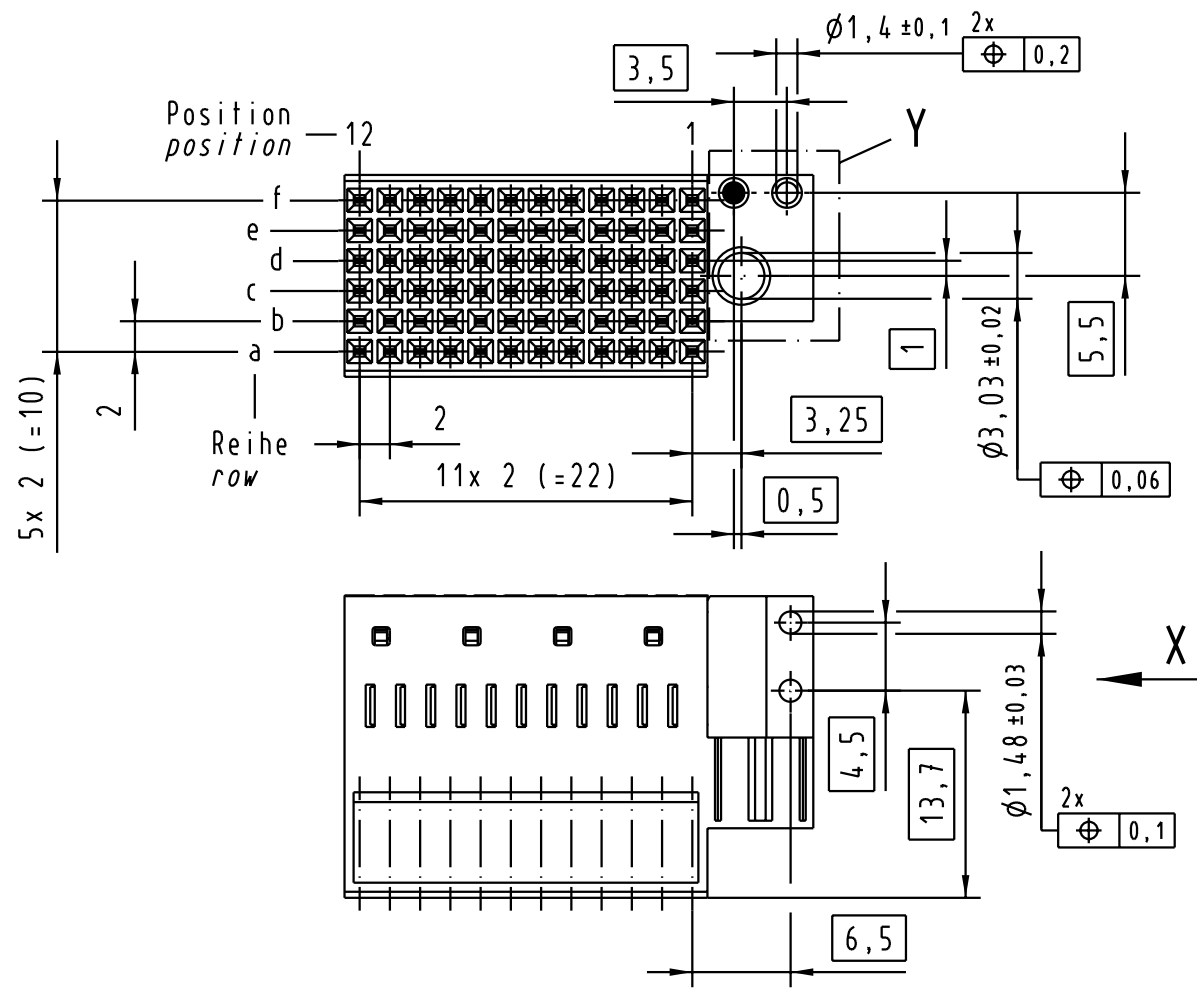

*) Löcher nicht metallisiert
non-metallized drillings

Bohrlochdurchmesser: $\phi 0,7 \pm 0,02$ mm
 Lochdurchmesser (mit Oberfläche): $\phi 0,6 \pm 0,05$ mm
 drill hole dia.: $\phi 0,7 \pm 0,02$ mm
 through hole dia. (after plating): $\phi 0,6 \pm 0,05$ mm

Lochbild
board drillings

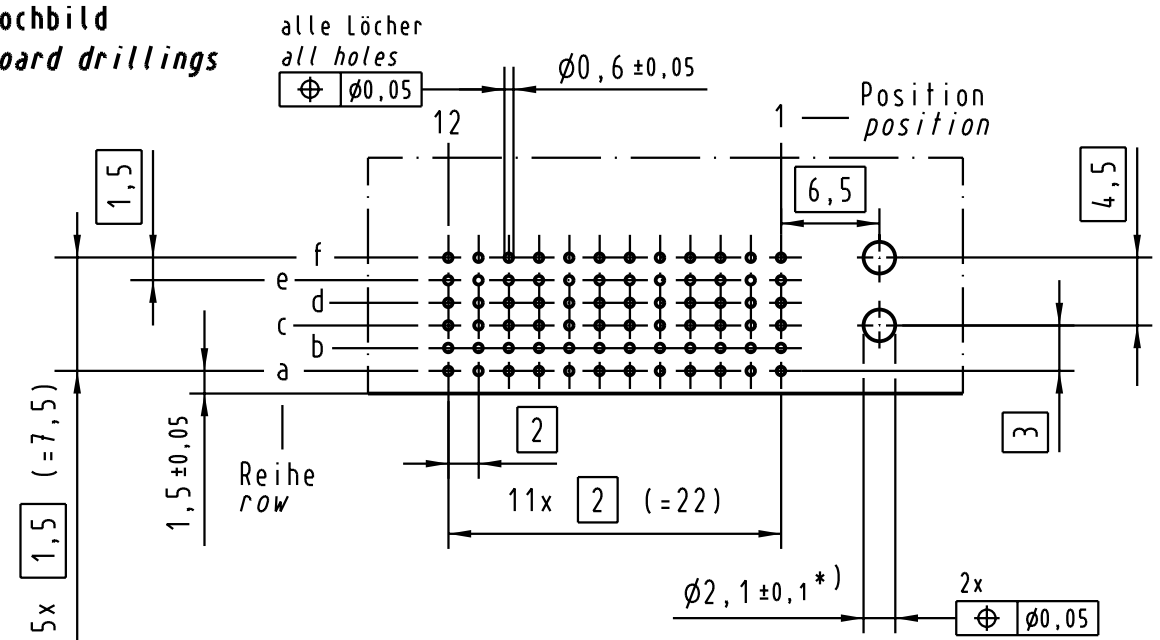

17 52 072 4106	-	min. 0,76 μ m (30 μ m) Au über/over min. 1,27 μ m (50 μ m) Ni
17 52 072 2106	2	Au über/over Ni
17 52 072 1106	1	Au über/over Ni
Bestell-Nr. Part-No.	Anforderungsstufe nach IEC Performance level per IEC	Kontaktoberfläche Contact Plating

			Techn. Character.		Nicht tolerierte Maßel Free size tolerances	
			Dat.	Name	Maßstab/Scale	
			Detail.	Bus.	2:1 (5:1)	
			Insp.	Ko	har-bus HM Federleiste 6-reihig mit Flansch links, 72 pol., Einpreß, Kodierung 1 har-bus HM female connector with guide on left side, 6-row, 72 pol., press-in, coding 1	
			Stand.			Blatt/ page
31808 Mod.	Dat.	Name	HARTING Electronics GmbH & Co. KG D-32339 ESPELKAMP		TB 17 52 072 x106	
					Sub.	