



Chipsmall Limited consists of a professional team with an average of over 10 year of expertise in the distribution of electronic components. Based in Hongkong, we have already established firm and mutual-benefit business relationships with customers from,Europe,America and south Asia,supplying obsolete and hard-to-find components to meet their specific needs.

With the principle of “Quality Parts,Customers Priority,Honest Operation,and Considerate Service”,our business mainly focus on the distribution of electronic components. Line cards we deal with include Microchip,ALPS,ROHM,Xilinx,Pulse,ON,Everlight and Freescale. Main products comprise IC,Modules,Potentiometer,IC Socket,Relay,Connector.Our parts cover such applications as commercial,industrial, and automotives areas.

We are looking forward to setting up business relationship with you and hope to provide you with the best service and solution. Let us make a better world for our industry!



## Contact us

Tel: +86-755-8981 8866 Fax: +86-755-8427 6832

Email & Skype: info@chipsmall.com Web: www.chipsmall.com

Address: A1208, Overseas Decoration Building, #122 Zhenhua RD., Futian, Shenzhen, China



**MSTB 2,5/ 5-ST-5,08**

Order No.: 1757048

<http://eshop.phoenixcontact.de/phoenix/treeViewClick.do?UID=1757048>

Plug component, Nominal current: 12 A, Nom. voltage: 250 V, Pitch:  
5.08 mm, Number of positions: 5, Connection type: Screw connection,  
Color: green

**Commercial data**

EAN	4017918029579
Pack	50 pcs.
Customs tariff	85366990
Weight/Piece	0.00864 KG
Catalog page information	Page 198 (CC-2009)

**Product notes**

WEEE/RoHS-compliant since:  
01/01/2003



<http://www.download.phoenixcontact.com>  
Please note that the data given here has been taken from the online catalog. For comprehensive information and data, please refer to the user documentation. The General Terms and Conditions of Use apply to Internet downloads.

**Technical data****Dimensions / positions**

Pitch	5.08 mm
Dimension a	20.32 mm
Number of positions	5
Screw thread	M3

Tightening torque, min	0.5 Nm
Tightening torque max	0.6 Nm

**Technical data**

Insulating material group	I
Rated surge voltage (III/3)	4 kV
Rated surge voltage (III/2)	4 kV
Rated surge voltage (II/2)	4 kV
Rated voltage (III/2)	320 V
Rated voltage (II/2)	630 V
Connection in acc. with standard	EN-VDE
Nominal current $I_N$	12 A
Nominal voltage $U_N$	250 V
Nominal cross section	2.5 mm <sup>2</sup>
Maximum load current	12 A (with 2.5 mm <sup>2</sup> conductor cross section)
Insulating material	PA
Inflammability class acc. to UL 94	V0
Internal cylindrical gage	A3
Stripping length	7 mm

**Connection data**

Conductor cross section solid min.	0.2 mm <sup>2</sup>
Conductor cross section solid max.	2.5 mm <sup>2</sup>
Conductor cross section stranded min.	0.2 mm <sup>2</sup>
Conductor cross section stranded max.	2.5 mm <sup>2</sup>
Conductor cross section stranded, with ferrule without plastic sleeve min.	0.25 mm <sup>2</sup>
Conductor cross section stranded, with ferrule without plastic sleeve max.	2.5 mm <sup>2</sup>
Conductor cross section stranded, with ferrule with plastic sleeve min.	0.25 mm <sup>2</sup>
Conductor cross section stranded, with ferrule with plastic sleeve max.	2.5 mm <sup>2</sup>
Conductor cross section AWG/kcmil min.	24
Conductor cross section AWG/kcmil max	12
2 conductors with same cross section, solid min.	0.2 mm <sup>2</sup>
2 conductors with same cross section, solid max.	1 mm <sup>2</sup>

2 conductors with same cross section, stranded min.	0.2 mm <sup>2</sup>
2 conductors with same cross section, stranded max.	1.5 mm <sup>2</sup>
2 conductors with same cross section, stranded, ferrules without plastic sleeve, min.	0.25 mm <sup>2</sup>
2 conductors with same cross section, stranded, ferrules without plastic sleeve, max.	1 mm <sup>2</sup>
2 conductors with same cross section, stranded, TWIN ferrules with plastic sleeve, min.	0.5 mm <sup>2</sup>
2 conductors with same cross section, stranded, TWIN ferrules with plastic sleeve, max.	1.5 mm <sup>2</sup>

**Certificates / Approvals**



Certification CB, CSA, CUL, GOST, UL, VDE-PZI

**CSA**

Nominal voltage U <sub>N</sub>	300 V
Nominal current I <sub>N</sub>	10 A
AWG/kcmil	28-12

**CUL**

Nominal voltage U <sub>N</sub>	300 V
Nominal current I <sub>N</sub>	10 A
AWG/kcmil	30-12

**UL**

Nominal voltage U <sub>N</sub>	300 V
Nominal current I <sub>N</sub>	10 A
AWG/kcmil	30-12



<b>Accessories</b>		
Item	Designation	Description
<b>Bridges</b>		
1733172	EBP 3- 5	Insertion bridge, fully insulated, for plug connectors with 5.0 or 5.08 mm pitch, no. of positions: 3
1733185	EBP 4- 5	Insertion bridge, fully insulated, for plug connectors with 5.0 or 5.08 mm pitch, no. of positions: 4
1733198	EBP 5- 5	Insertion bridge, fully insulated, for plug connectors with 5.0 or 5.08 mm pitch, no. of positions: 5
<b>General</b>		
1733169	EBP 2- 5	Insertion bridge, fully insulated, for plug connectors with 5.0 or 5.08 mm pitch, no. of positions: 2
1803895	KGG-MSTB 2,5/ 5	Cable housing, Number of positions: 5, Dimension a: 25 mm, Color: green
<b>Marking</b>		
1051993	B-STIFT	Marker pen, for manual labeling of unprinted Zack strips, smear-proof and waterproof, line thickness 0.5 mm
0805108	SK 5,08/2,8:SO	Marker card, special printing, self-adhesive, labeled acc. to customer requirements, 14 identical marker strips per card, max. 25-position labeling per strip, color: White
0804293	SK 5,08/3,8:FORTL.ZAHLEN	Marker card, printed horizontally, self-adhesive, 12 identical decades marked 1-10, 11-20 etc. up to 91-(99)100, sufficient for 120 terminal blocks
0803883	SK U/2,8 WH:UNBEDRUCKT	Unprinted marker cards, DIN A4 format, pitch as desired, self-adhesive, with 50 stamped marker strips, 185 mm strip length, can be labeled with the CMS system or manually with the M-PEN
<b>Plug/Adapter</b>		
1734634	CP-MSTB	Keying profile, is inserted into the slot on the plug or inverted header, red insulating material
<b>Tools</b>		
1205053	SZS 0,6X3,5	Screwdriver, bladed, matches all screw terminal blocks up to 4.0 mm <sup>2</sup> connection cross section, blade: 0.6 x 3.5 mm, without VDE approval

**Additional products**

Item	Designation	Description
<b>General</b>		
1880339	EMSTBA 2,5/ 5-G-5,08	Header, Nominal current: 12 A, Nom. voltage: 250 V, Pitch: 5.08 mm, Number of positions: 5, Assembly: Press-in
1859548	EMSTBVA 2,5/ 5-G-5,08	Header, Nominal current: 12 A, Nom. voltage: 200 V, Pitch: 5.08 mm, Number of positions: 5, Assembly: Press-in
1873388	FKIC 2,5/ 5-ST-5,08	Plug component, Nominal current: 12 A, Nom. voltage: 320 V, Pitch: 5.08 mm, Number of positions: 5, Connection type: Spring-cage conn.
1823875	ICC 2,5/ 5-STZ-5,08	Plug component, Nominal current: 12 A, Nom. voltage: 250 V, Pitch: 5.08 mm, Number of positions: 5, Connection type: Crimp connection
1842092	MDSTBA 2,5/ 5-G-5,08	Header, Nominal current: 10 A, Nom. voltage: 250 V, Pitch: 5.08 mm, Number of positions: 5, Assembly: Soldering
1770740	MSTB 2,5/ 5-G-5,08-LA	Header, Nominal current: 12 A, Nom. voltage: 250 V, Pitch: 5.08 mm, Number of positions: 5, Assembly: Soldering
1757271	MSTBA 2,5/ 5-G-5,08	Header, Nominal current: 12 A, Nom. voltage: 250 V, Pitch: 5.08 mm, Number of positions: 5, Color: green, Assembly: Soldering
1770973	MSTBA 2,5/ 5-G-5,08-LA	Header, Nominal current: 12 A, Nom. voltage: 250 V, Pitch: 5.08 mm, Number of positions: 5, Assembly: Soldering
1788758	MSTBVK 2,5/ 5-G-5,08	Plug component, Nominal current: 12 A, Nom. voltage: 320 V, Pitch: 5.08 mm, Number of positions: 5, Connection type: Screw connection, Assembly: DIN rail, Color: green
1788567	MVSTBU 2,5/ 5-GB-5,08	Plug component, Nominal current: 12 A, Nom. voltage: 320 V, Pitch: 5.08 mm, Number of positions: 5, Connection type: Screw connection, Assembly: Direct mounting
1769492	SMSTB 2,5/ 5-G-5,08	Header, Nominal current: 12 A, Nom. voltage: 250 V, Pitch: 5.08 mm, Number of positions: 5, Color: green, Assembly: Soldering
1767407	SMSTBA 2,5/ 5-G-5,08	Header, Nominal current: 12 A, Nom. voltage: 250 V, Pitch: 5.08 mm, Number of positions: 5, Color: green, Assembly: Soldering
3002034	UK 3-MSTB-5,08	Feed-through modular terminal block, Type of connection: Special and hybrid connection, Screw connection, Cross section: 0.2 mm <sup>2</sup> - 4 mm <sup>2</sup> , AWG 24 - 12, Width: 5.08 mm, Color: gray, Mounting type: NS 32, NS 35/15, NS 35/7,5
3002076	UK 3-MVSTB-5,08	Feed-through modular terminal block, Nominal current: 12 A, Nominal voltage: 250 V, Cross section: 0.2 mm <sup>2</sup> - 4 mm <sup>2</sup> , AWG: 24 - 12, Mounting type: NS 32, NS 35/15, NS 35/7,5, Pitch: 5.08 mm, Width: 5.1, Color: gray
3002102	UK 3-MVSTB-5,08-LA 24RD	Feed-through modular terminal block, Nominal current: 12 A, Nominal voltage: 250 V, Cross section: 0.2 mm <sup>2</sup> - 4 mm <sup>2</sup> , AWG: 24 - 12, Mounting type: NS 32, NS 35/15, NS 35/7,5, Pitch: 5.08 mm, Width: 5.08, Color: gray

3002063	UK 3-MVSTB-5,08/EK	Feed-through modular terminal block, Nominal current: 12 A, Nominal voltage: 250 V, Cross section: 0.2 mm <sup>2</sup> - 4 mm <sup>2</sup> , AWG: 24 - 12, Mounting type: NS 35/7,5, NS 35/15, NS 32, Pitch: 5.08 mm, Width: 5.1, Color: blue
3002131	UK 3D-MSTBV-5,08	Feed-through modular terminal block, Type of connection: Special and hybrid connection, Screw connection, Cross section: 0.2 mm <sup>2</sup> - 4 mm <sup>2</sup> , AWG 24 - 12, Width: 5.08 mm, Color: gray, Mounting type: NS 32, NS 35/15, NS 35/7,5
3002144	UK 3D-MSTBV-5,08-LA 24RD	Feed-through modular terminal block, Type of connection: Screw connection, Screw connection, Number of positions: 1, Cross section: 0.2 mm <sup>2</sup> - 4 mm <sup>2</sup> , AWG 24 - 12, Width: 5.1 mm, Color: gray, Mounting type: NS 32, NS 35/15, NS 35/7,5
3002173	UK 3D-MSTBV-5,08/EK	Feed-through modular terminal block, Type of connection: Screw connection, Screw connection, Cross section: 0.2 mm <sup>2</sup> - 4 mm <sup>2</sup> , AWG 24 - 12, Width: 5.1 mm, Color: blue, Mounting type: NS 32, NS 35/15, NS 35/7,5
2770888	UKK 3-MSTB-5,08	Feed-through modular terminal block, Nominal current: 12 A, Nominal voltage: 250 V, Cross section: 0.2 mm <sup>2</sup> - 4 mm <sup>2</sup> , AWG: 24 - 12, Mounting type: NS 35/7,5, NS 35/15, NS 32, Pitch: 5.08 mm, Width: 5.08, Color: gray
1876615	UKK 3-MSTB-5,08-PE	Feed-through modular terminal block, Nominal current: 12 A, Nominal voltage: 320 V, Cross section: 0.2 mm <sup>2</sup> - 4 mm <sup>2</sup> , AWG: 24 - 12, Mounting type: NS 35/7,5, NS 35/15, NS 32, Pitch: 5.08 mm, Width: 5.08, Color: green-yellow
2770846	UKK 3-MSTBVH-5,08	Feed-through modular terminal block, Nominal current: 12 A, Nominal voltage: 250 V, Cross section: 0.2 mm <sup>2</sup> - 4 mm <sup>2</sup> , AWG: 24 - 12, Mounting type: NS 35/7,5, NS 35/15, NS 32, Pitch: 5.08 mm, Width: 5.08, Color: gray
1788143	UMSTBVK 2,5/ 5-G-5,08	Plug component, Nominal current: 12 A, Nom. voltage: 320 V, Pitch: 5.08 mm, Number of positions: 5, Connection type: Screw connection, Assembly: DIN rail, Color: green
1873016	ZFKK 1,5-MSTBV-5,08	Feed-through modular terminal block, Connection method: Special and hybrid connection, MSTB plug entry, Cross section: 0.2 mm <sup>2</sup> - 2.5 mm <sup>2</sup> , Width: 5.1 mm, Color: gray

## Diagrams/Drawings

### Diagram

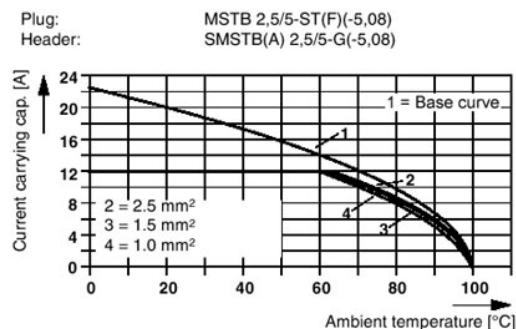
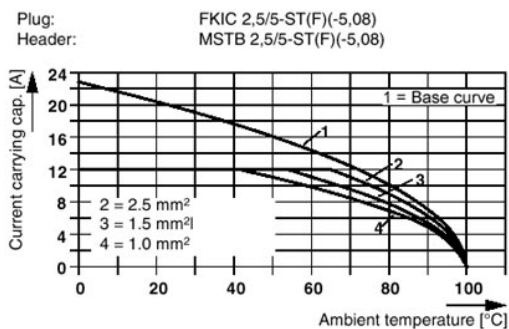

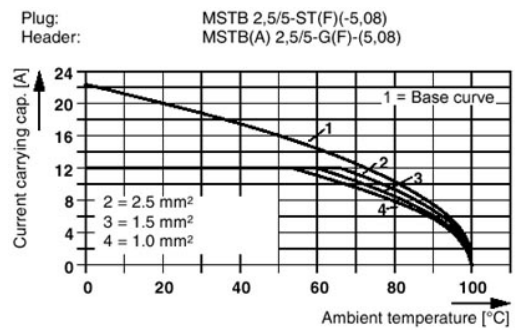
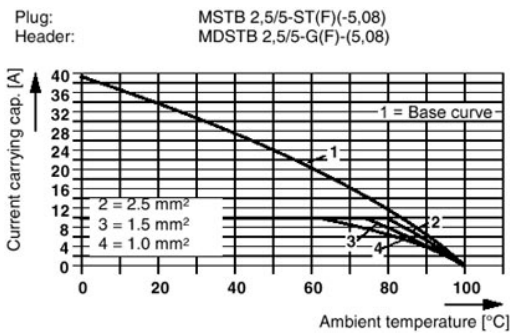
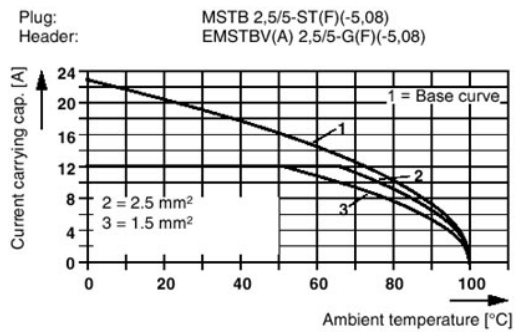
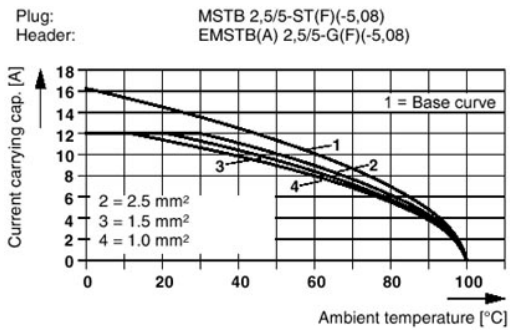

Dimensioned drawing

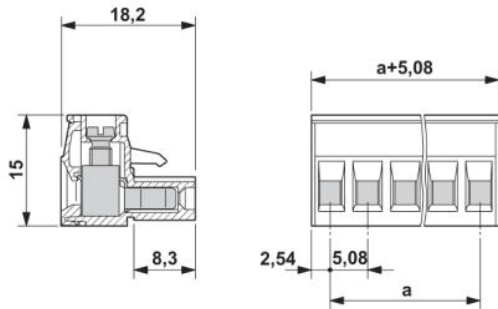



**Address**

PHOENIX CONTACT Inc., USA  
586 Fulling Mill Road  
Middletown, PA 17057, USA  
Phone (800) 888-7388  
Fax (717) 944-1625  
<http://www.phoenixcon.com>



© 2010 Phoenix Contact  
Technical modifications reserved;