



Chipsmall Limited consists of a professional team with an average of over 10 year of expertise in the distribution of electronic components. Based in Hongkong, we have already established firm and mutual-benefit business relationships with customers from,Europe,America and south Asia,supplying obsolete and hard-to-find components to meet their specific needs.

With the principle of “Quality Parts,Customers Priority,Honest Operation,and Considerate Service”,our business mainly focus on the distribution of electronic components. Line cards we deal with include Microchip,ALPS,ROHM,Xilinx,Pulse,ON,Everlight and Freescale. Main products comprise IC,Modules,Potentiometer,IC Socket,Relay,Connector.Our parts cover such applications as commercial,industrial, and automotives areas.

We are looking forward to setting up business relationship with you and hope to provide you with the best service and solution. Let us make a better world for our industry!



## Contact us

Tel: +86-755-8981 8866 Fax: +86-755-8427 6832

Email & Skype: info@chipsmall.com Web: www.chipsmall.com

Address: A1208, Overseas Decoration Building, #122 Zhenhua RD., Futian, Shenzhen, China



## GMSTBVA 2,5/ 3-G-7,62

Order No.: 1766783

The figure shows a 10-position version of the product

<http://eshop.phoenixcontact.de/phoenix/treeViewClick.do?UID=1766783>Header, Nominal current: 12 A, Nom. voltage: 400 V, Pitch: 7.62 mm,  
Number of positions: 3, Color: green, Assembly: Soldering

### Commercial data

EAN	4017918032807
Pack	50 pcs.
Customs tariff	85366990
Weight/Piece	0.00171 KG
Catalog page information	Page 277 (CC-2009)

### Product notes

WEEE/RoHS-compliant since:  
01/01/2003

<http://www.download.phoenixcontact.com>  
Please note that the data given here has been taken from the online catalog. For comprehensive information and data, please refer to the user documentation. The General Terms and Conditions of Use apply to Internet downloads.

### Technical data

#### Dimensions / positions

Length	8.6 mm
Pitch	7.62 mm
Dimension a	15.24 mm
Number of positions	3
Pin dimensions	1 x 1 mm

Hole diameter	1.4 mm
<b>Technical data</b>	
Insulating material group	I
Rated surge voltage (III/3)	6 kV
Rated surge voltage (III/2)	6 kV
Rated surge voltage (II/2)	6 kV
Rated voltage (III/2)	630 V
Rated voltage (II/2)	630 V
Connection in acc. with standard	EN-VDE
Nominal current $I_N$	12 A
Nominal voltage $U_N$	400 V
Maximum load current	12 A
Insulating material	PA
Inflammability class acc. to UL 94	V0

#### Certificates / Approvals



Certification CB, CSA, CUL, GOST, UL, VDE-PZI

#### CSA

Nominal voltage $U_N$	300 V
Nominal current $I_N$	10 A

#### CUL

Nominal voltage $U_N$	300 V
Nominal current $I_N$	10 A

#### UL

Nominal voltage $U_N$	300 V
Nominal current $I_N$	10 A

**Accessories**

Item	Designation	Description
<b>Assembly</b>		
1755477	MSTB-BL	Keying cap, for forming sections, plugs onto header pin, green insulating material
<b>Marking</b>		
0804549	SK 7,62/3,8:FORTL.ZAHLEN	Marker card, printed horizontally, self-adhesive, 10-section marker strip, 12 identical decades marked 1-10, 11-20 etc. up to 91-99, sufficient for 120 terminal blocks
<b>Plug/Adapter</b>		
1734401	CR-MSTB	Coding section, inserted into the recess in the header or the inverted plug, red insulating material

**Additional products**

Item	Designation	Description
<b>General</b>		
1806122	FRONT-GMSTB 2,5/ 3-ST-7,62	Plug component, Nominal current: 12 A, Nom. voltage: 400 V, Pitch: 7.62 mm, Number of positions: 3, Connection type: Screw connection, Color: green
1828689	GIC 2,5/ 3-G-7,62	Header, Nominal current: 12 A, Nom. voltage: 500 V, Pitch: 7.62 mm, Number of positions: 3, Assembly: Soldering
1828922	GICV 2,5/ 3-G-7,62	Header, Nominal current: 12 A, Nom. voltage: 500 V, Pitch: 7.62 mm, Number of positions: 3, Assembly: Soldering
1767012	GMSTB 2,5/ 3-ST-7,62	Plug component, Nominal current: 12 A, Nom. voltage: 400 V, Pitch: 7.62 mm, Number of positions: 3, Connection type: Screw connection, Color: green
1832536	GMVSTBR 2,5/ 3-ST-7,62	Plug component, Nominal current: 12 A, Nom. voltage: 500 V, Pitch: 7.62 mm, Number of positions: 3, Connection type: Screw connection, Color: green
1832426	GMVSTBW 2,5/ 3-ST-7,62	Plug component, Nominal current: 12 A, Nom. voltage: 500 V, Pitch: 7.62 mm, Number of positions: 3, Connection type: Screw connection, Color: green

## Diagrams/Drawings

Drilling plan/solder pad geometry

---

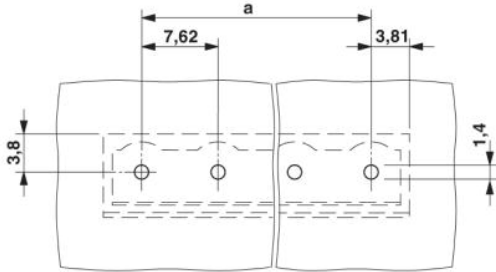

Dimensioned drawing

---

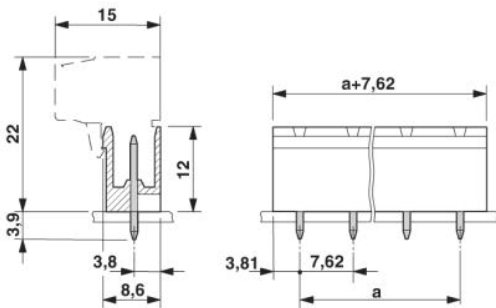

**Address**

PHOENIX CONTACT Inc., USA  
586 Fulling Mill Road  
Middletown, PA 17057, USA  
Phone (800) 888-7388  
Fax (717) 944-1625  
<http://www.phoenixcon.com>



© 2010 Phoenix Contact  
Technical modifications reserved;