



Chipsmall Limited consists of a professional team with an average of over 10 year of expertise in the distribution of electronic components. Based in Hongkong, we have already established firm and mutual-benefit business relationships with customers from,Europe,America and south Asia,supplying obsolete and hard-to-find components to meet their specific needs.

With the principle of “Quality Parts,Customers Priority,Honest Operation,and Considerate Service”,our business mainly focus on the distribution of electronic components. Line cards we deal with include Microchip,ALPS,ROHM,Xilinx,Pulse,ON,Everlight and Freescale. Main products comprise IC,Modules,Potentiometer,IC Socket,Relay,Connector.Our parts cover such applications as commercial,industrial, and automotives areas.

We are looking forward to setting up business relationship with you and hope to provide you with the best service and solution. Let us make a better world for our industry!



Contact us

Tel: +86-755-8981 8866 Fax: +86-755-8427 6832

Email & Skype: info@chipsmall.com Web: www.chipsmall.com

Address: A1208, Overseas Decoration Building, #122 Zhenhua RD., Futian, Shenzhen, China



ELCON Drawer Series Connectors
True Hot-Plug, Blind-Mating Mixed Signal and Power Connectors

Product Facts

- Wide variety of contact sizes and styles from 1 Amp signals up to power contacts rated at up to 200 Amps each
- Sequenced contacts for “mate-first-break-last” operation
- Floating panel-mount connectors float up to +/- 2 mm
- High durability specific products ranging from 100 to 1000 mate/un-mate cycles
- Customizable products allow the freedom to add or remove power or signal contacts to meet specific application requirement
- Most products recognized to US and Canadian requirements under the Component Recognition program of Underwriters Laboratories File No. E28476



Typical Applications

- Low noise power supplies
- Switch-mode power supplies (SMPS)
- Power factor-correcting (PFC) power supplies
- Systems requiring mounting to backplane or chassis
- Redundant (N + 1) power systems
- “Live” hot-plug power supplies
- All ELCON drawer connectors in this section are RoHS compliant

Technical Documents

Product Specification
108-2285

Application Specification
114-13206

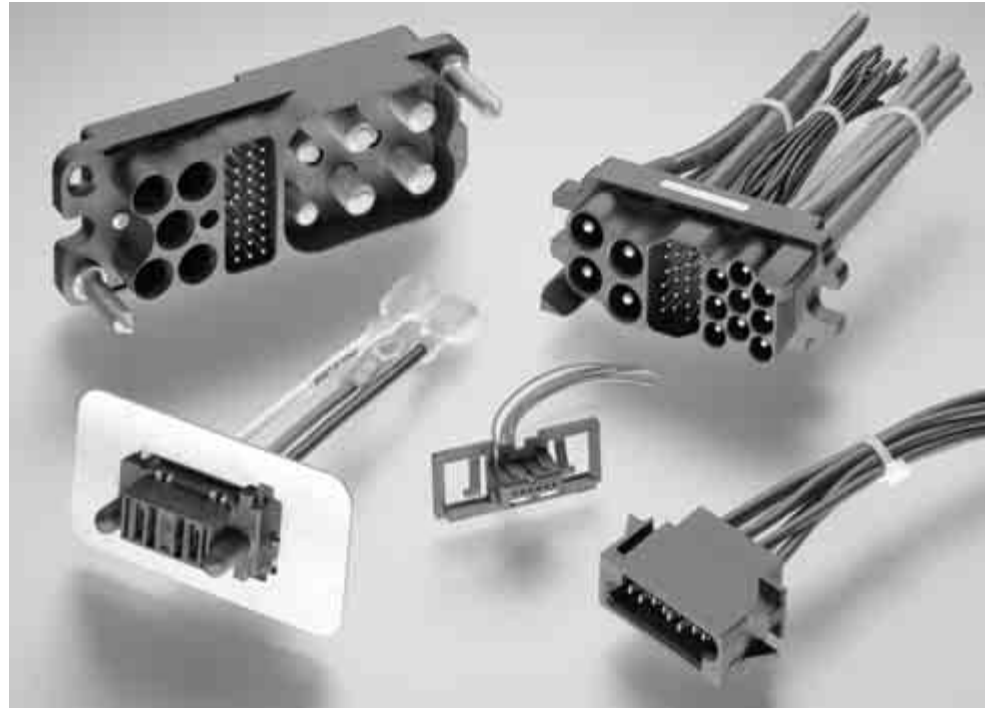

Tyco Electronics offers a wide selection of blind-mateable “drawer” connectors to suit modular equipment designs. The term “drawer connector” was created to describe a cabinet drawer where the connector is installed at the back of the drawer and is mated by closing the drawer. Since the “drawer” is often times made with a somewhat loose fit — to enable easy opening and closing, the drawer connector must provide sufficient self-alignment and ideally a floating connection to the cabinet or drawer to keep the connection from binding.

The power drawer connectors in this catalog are divided into two separate categories: high power drawers and low power drawers. Specifically, the

product line names in these two categories are:

High Power Drawer Connectors

- ELCON Drawer Series Connectors

Low Power Drawer Connectors

- AMP Drawer Series Connectors
 - Mini Power Drawer
 - Blind-mate Drawer Connectors
 - Hybrid Mini Drawer Connectors

Some of the benefits of the power drawer connectors from Tyco Electronics are the robustness of the housing designs and the durability of the contacts. High-end applications such as networking switches and servers want the lowest possible voltage drop across the connector. For these applications the high conductivity screw-machined contacts with either gold or silver plating offer the best performance.

The contacts are the core of the ELCON drawer series connectors. For cost sensitive applications the different hybrid drawer connectors offer a wide variety of shapes and sizes aimed at keeping cost minimized and still providing a reliable separable interface.

Regardless of the application, Tyco Electronics offers a wide variety of power & signal blind-mateable drawer connectors.

Need more information?

Call Technical Support at the numbers listed below.

Technical Support is staffed with specialists well versed in all Tyco Electronics products. They can provide you with:

- Technical Support
- Catalogs
- Technical Documents
- Product Samples
- Tyco Electronics Authorized Distributor Locations

ELCON Drawer Series Connectors
True Hot-Plug, Blind-Mating Mixed Signal and Power Connectors (Continued)

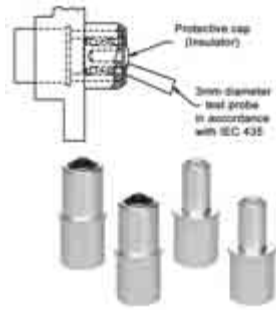

3 mm Diameter Test Probe in Accordance with IEC 435 Protective Cap (insulator)

Probe-proof Double CROWN BAND Contacts

The size #0 contacts used in the Top Drawer, Double Drawer, DualPower and QuadPower connectors are also available in a probe-proof double CROWN BAND version. These contacts are specially suited for operator-serviced power supplies that require extra safety protection.

Signal/Power Sequencing

All signal and some power contacts are available in various lengths to allow multiple levels of sequencing, thus giving the engineer further design flexibility.

Mating Polarization

To provide for positive housing mating of connectors, polarization is provided in the form of molded-in guide posts or pre-installed guide pins.

Regulatory Agency Certifications

Tyco Electronics ELCON drawer series connectors have been evaluated and found to comply with the UL1977 standard and the CSA standard C22.2 No. 182.3-M1987.

Tyco Electronics can also work with the customer to obtain application-specific regulatory certifications if needed.



Wide Array of Standard Contacts

ELCON drawer connectors support various termination styles, including crimp for cable, solder tail and compliant press-fit for mounting

to PCB, and internal/external threads for termination to lugs and/or busbars. See table below for details.

Contact Size	Termination				
	PC Tail	Press-fit	Crimp	Threaded	
				Internal	External
#20	•	•	•		
#16	•	•	•		
#12	•	•	•		
#8	•	•	•	•	•
#4			•	•	•
#0			•	•	•

Application-Specific Designs

If none of our standard drawer connectors satisfies your requirements, Tyco Electronics can develop an ELCON connector design specific to your application. We will

work closely with your engineers to fully understand the design requirements and develop an interconnect solution that meets your stated needs. After the concept and design stages,

Tyco Electronics produces prototypes that perform both electrically and mechanically the same as production parts. These machined parts are used for testing, regulatory

agency evaluations and even as pre-production components, allowing the shortest lead time from concept to manufacturing in the industry.

Concept

Tyco Electronics engineers work closely with the customer to fully understand the design requirements.



Design

A sketch drawing of the design concept is created for customer review, and the design is finalized only when it fully meets the requirements of the customer.



Prototypes

The design is frozen and work on the mold tools starts. Meanwhile, Tyco Electronics builds prototypes that are identical to the production parts.



Production

By the time the customer is ready for production, all requirements for release to production, such as qualification and regulatory agency approval, have been cleared.



How to Tailor Your ELCON Drawer Connector

If you selected a standard drawer connector for your application, before placing an order you need to specify your application-specific requirements, such as housing type, contact loading, and termination style. Layout forms for all standard drawer connectors, such as the one shown below, are available online at <http://www.tycoelectronics.com> or can be obtained from Tyco Electronics customer service for

this purpose. Complete a form for the pin and socket side of your connector as indicated in the instructions and fax it to your Tyco Electronics sales engineer. We will issue a unique part number specific to your configuration, which you can then use to place orders. Samples and customer drawings are also available upon request.

Pin Assembly

1. Choose one housing from the **Pin Housing Selection Menu** table. Place an X in the appropriate guide pin circles, if guide pins are required.
2. Write the total quantity of each pin contact you require for each pin assembly in the **Qty** column of the **Pin Contact Selection Menu** table.
3. Crimp contacts are shipped uninstalled. Threaded and PCB tail contacts are installed by Tyco Electronics; enter the letter reference of the desired contact in the appropriate contact positions on the drawing: e.g., if you need a size #20 premate PCB tail standard contact to be installed in contact position #10, write "Q" in circle #10.
4. Sign, date and send the completed form to your local Tyco Electronics Sales Engineer.

Pin Connector (Rear Face)

Pin Contact Insertion Side

Pin Connector Rear Face Cavity Identification

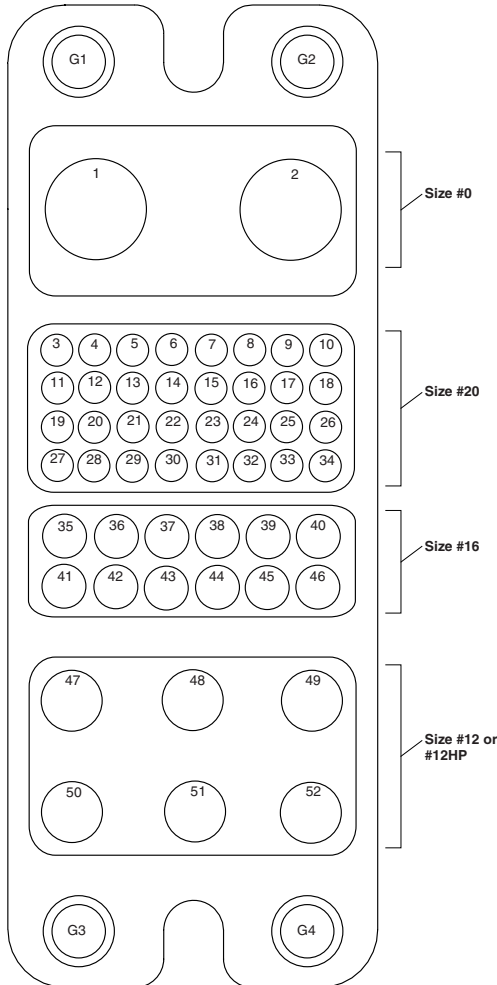

Top Assembly Part Number Assigned by Tyco Electronics

ENTER CUSTOMER INFORMATION	
Company	Location
Contact Name	Title
Telephone	Fax
Email Address	
I am: <input type="checkbox"/> End user <input type="checkbox"/> Contract manufacturer (end user: _____)	
Signature	Today's Date
	Annual Quantity Required

Submit to your local Tyco Electronics Sales Engineer.

Pin Housing Selection Menu		Check One
Part Number	Description	
1648183-1	Housing without guides	
	Housing with guides (#6-32 thread)	
	Housing with guides (M3 x 0.5 thread)	

Pin Contact Selection Menu				Qty.
Size	Ref.	Part Number	Termination Style & Pin Length	
#0	A =	1766811-1	Crimp	
	B =	1766819-1	Probe Proof, crimp	
	C =	1766230-1	1/4-20 Internal Thread	
	D =	1766274-1	M6 x 1 Internal Thread	
	E =	1766269-1	Probe Proof, 1/4-20 Internal Thread	
	F =	1766275-1	Probe Proof, M6 x 1 Internal Thread	
	G =	1766268-1	1/4-20 External Thread	
	H =	1766231-1	M6 x 1 External Thread	
	J =	1766270-1	Probe Proof, 1/4-20 External Thread	
	K =	1766276-1	Probe Proof, M6 x 1 External Thread	
	#20	L =	1650155-1	Crimp, standard
M =		1650161-1	Crimp, premate	
N =		1650162-2	Crimp, postmate	
P =		1650283-1	PCB tail, standard	
Q =		1650065-1	PCB tail, premate	
R =		1650226-1	PCB tail, postmate	
S =		1766196-1	Crimp, standard	
T =		1766198-1	Crimp, premate	
#16	U =	1766199-2	Crimp, postmate	
	V =	1766222-1	PCB tail, standard	
	W =	1766223-1	PCB tail, premate	
	X =	1766818-1	PCB tail, postmate	
	Y =	1766193-1	Crimp, standard	
	Z =	1766195-1	Crimp, premate	
#12	AA =	1766196-1	Crimp, postmate	
	AB =	1766245-1	PCB tail, standard	
	AC =	1766250-1	PCB tail, premate	
	AD =	1766249-1	PCB tail, postmate	
#12 Hot-Plug	AE =	1650153-2	Crimp, standard, Hot-Plug	
	AF =	1650156-2	Crimp, premate, Hot-Plug	
	AG =	1650060-2	PCB tail, standard, Hot-Plug	
	AH =	1650074-3	PCB tail, premate, Hot-Plug	

Crimp and Threaded contacts are removable. PCB tail contacts are non-removable.

Float-Mount Shoulder Screw		Qty.
Part Number	Description	
1650399-1	Screw, No 10-32 UNC 2A	
1650401-1	Screw, M5 x 0.8	

ELCON Drawer Connector Mounting

All ELCON drawer series connectors can be fix-mounted or float-mounted using the designated shoulder screws to allow improved gatherability for blind-mating of the connector. Panel cut out dimensions are shown on the customer drawing specific to your ELCON drawer connector.

Panel Float Mounting

When float-mounting to a panel or chassis, use the stainless steel shoulder screws specified in the layout sheet or customer drawing specific to your ELCON drawer connector. Shown in the sketch below is an example of how the Top Drawer connector is float-mounted to a panel.

Float-Mount of Top Drawer (Example)

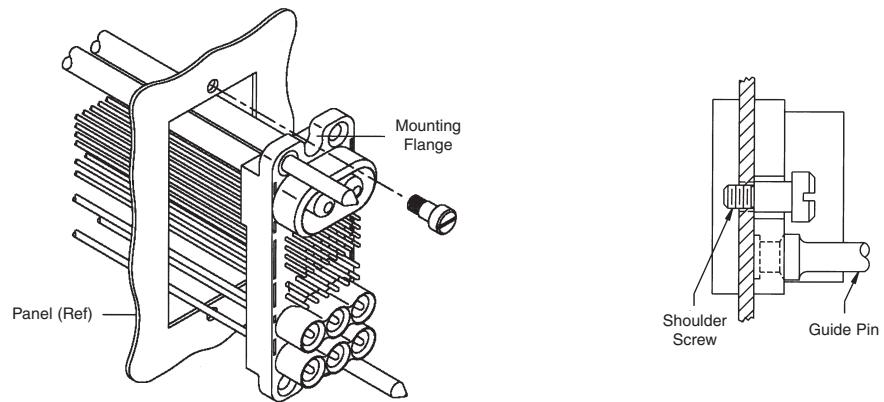

Screw Description	Part Number	Used On
#10-32 UNF 2A Thread	1650399-1	Top and Double Drawer, Dual and QuadPower, In-Line QuadPower, W5 Drawer
M5 x 0.8 Metric Thread	1650401-1	
#8-32 UNF 2A Thread	1650402-1	
#6-32 UNF 2A Thread	1650106-1	All Other Drawers
M4 x 0.7 Metric Thread	1650589-1	

Panel Fix Mounting

As a rule of thumb, ELCON drawer connectors can be fix-mounted to a panel, in two ways: (1) by attaching a screw through the top and bottom mounting flange of the housing; or (2) by attaching a screw into a threaded guide pin (for those connectors that have one). An example of each case is shown in the sketches below.

Screw Through Mounting Flange of Housing

Fix to the panel by attaching a commercially available screw and a washer through the top and bottom mounting flange of the housing.

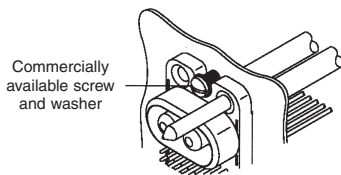

Screw Into Thread of Guide Pin (When Applicable)

You can optionally fix-mount housings that have a guide pin by attaching a commercially available screw and washer into the thread on the back of the guide pin, as shown in the figures below.

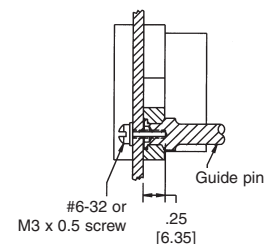
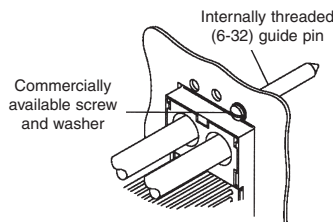

Note: All part numbers are RoHS compliant.

ELCON Drawer Connector Mounting (Continued)

Strain Relief and Wire Dress

If required, wires can be bundled together and supported with cable ties. Wires must not be stretched or confined in any way that would restrict the floating action of the connectors. Therefore, the wires must remain perpendicular to the connector and avoid an excessively sharp bend radius. The minimum recommended distance for the cable tie, and the minimum bend radius of a wire bundle are shown in the figure to the right.

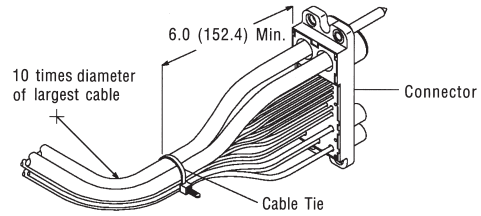

PCB Fix Mounting

When mounting to a PC board, the connector standoffs must be seated on the board. Hold-downs are recommended to provide stability during the soldering procedure. PCB-mount hole patterns are shown on the customer drawing specific to your ELCON drawer connector.

Flush PCB-Mount Drawer Connectors

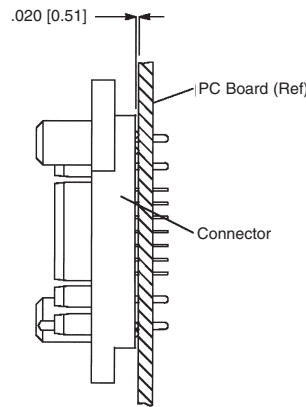

Drawer Connectors with Cabled AC IN

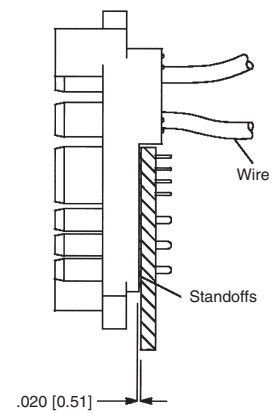

Connector Engagement

To provide for proper mating of the connector when the power supply unit is fully engaged into the system, the gap between the pin and socket (shown as dimension "A" in the sketch below) must be within the limit specified in the customer drawing for your ELCON drawer connector. Failure to meet this requirement may compromise contact wipe. Refer to the customer drawing for details. ELCON drawer connectors are polarized and will only mate in the correct orientation (see sketch below).

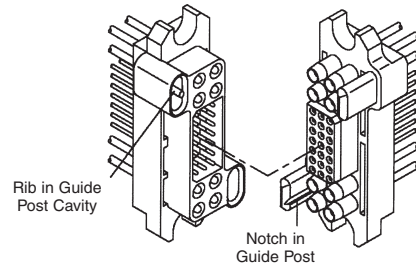
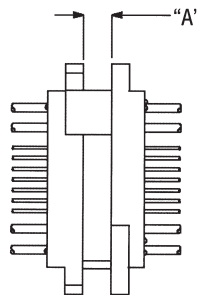

ELCON Drawer Connector Tooling

Insertion/Removal (I/R) Tools: Industry standard plastic I/R tooling is compatible with all crimp contacts for pin and socket removal. The following tools are available from Tyco Electronics.

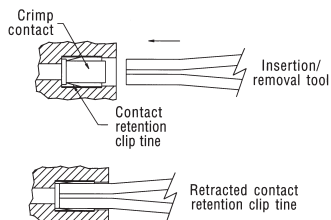

I/R Tools

Part Numbers	Size	Color Code
1643917-1	Size #20 I/R tool	Red/White
1643916-1	Size #16 I/R tool	Blue/White
1643915-1	Size #12 I/R tool	Yellow/White
1643914-1	Size #8 removal tool	Red
1643922-1	Size #4 removal tool	Blue
1643921-1	Size #0 removal tool	Light Yellow

Note: PCB tail contacts are non-removable.

Wire strip length: If inserting stranded wire into crimp style contacts, please use the table below to determine the proper strip length of the wire.

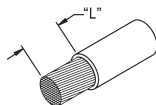

Contact Size	Wire Size AWG	"L" + .020 [0.51]	
		inches	mm
#20	#24 - #20	0.210	5.33
#16	#20 - #16	0.270	6.86
#12	#14 - #12	0.270	6.86
#8	#10* - #8	0.500	12.70
#4	#6* - #4	0.500	12.70
#0	#2* - #0	0.600	15.24

*Ref: MS3348 "Contact Bushing, Electric, Wire Barrel"

Crimp Tools: The following table lists applicable MIL-STD crimp tools for contacts



Size	Type	MIL-STD	Part Number
12 - 24	Crimp Tool	M22520/1-01	601967-1
	Turret head/locator	M22520/1-02	601967-2
8 - 10	Crimp Tool	M22520/23-01	—
	Indenter head	M22520/23-02	—
	Locator	M22520/23-09	—
4	Crimp Tool	M22520/23-01	—
	Indenter head	M22520/23-04	—
	Locator	M22520/23-11	—
0	Crimp Tool	M22520/23-01	—
	Indenter head	M22520/23-05	—
	Locator	M22520/23-13	—

Crimp Termination Wire Sizes: The following table shows crimp rear release contacts and their respective wire sizes when crimped with applicable industry standard terminal tools.

Contact Size	Wire Range	
	AWG	mm ²
#20	20 - 24	0.241 - 0.616
#16	16 - 18	0.963 - 1.23
#12	12 - 14	1.94 - 2.98
#8	10 - 8	4.74 - 8.61
#4	4 (1)	21.60
#0	1/0	53.00

Note: (1) Consult Tyco Electronics for smaller wire sizes in #4 contacts

Note: All part numbers are RoHS compliant.

ELCON Drawer Product Specifications

Materials			
Housing	Polyester, 30% glass-filled, UL 94V-0 black		
Crimp Contacts	High conductivity copper alloy		
PCB Tails	Brass		
Socket Contact Hoods (when applicable)	305 corrosion resistant steel		
Size #12 hoods, Hot-Plug	Beryllium copper		
Crown contacts	Beryllium copper		
Plating			
Size #20 and #12HP	Gold plated over nickel		
Sizes #0, #4, #8, #16 and non-HP #12	Silver plated over nickel		
Hot-Plug hoods and pin contacts	Gold plated over nickel		
Socket Contact Hoods (when applicable)	Passivated		
Mechanical			
Typical Insertion Forces of individual contacts	Size #20	0.2 lb.	0.09 kg
	Size #16	2.3 lb.	1.04 kg
	Size #12	2.9 lb.	1.32 kg
	Size #12 Hot-Plug	2.9 lb.	1.32 kg
	Size #8	4.4 lb.	2.00 kg
	Size #4	3.8 lb.	1.72 kg
	Size #0	4.7 lb.	2.13 kg
	Size #0 w/double Crown	4.8 lb.	2.18 kg
Typical Extraction Forces of individual contacts	Size #20	0.1 lb.	0.05 kg
	Size #16	0.7 lb.	0.32 kg
	Size #12	1.9 lb.	0.86 kg
	Size #12 Hot-Plug	1.9 lb.	0.86 kg
	Size #8	2.4 lb.	1.07 kg
	Size #4	3.0 lb.	1.36 kg
	Size #0	3.0 lb.	1.36 kg
	Size #0 w/double Crown	3.5 lb.	1.59 kg
Electrical			
Typical Voltage drop of individual contacts	Size #20	1.7 mV at 5A	
	Size #16	3 mV at 15A	
	Size #12	4.2 mV at 35A	
	Size #12 Hot-Plug	4.7 mV at 35A	
	Size #8	6.5 mV at 75 A	
	Size #4	8.4 mV at 125A	
	Size #0	6.3 mV at 200A	
	Size #0 w/double Crown	5.6 mV at 200A	
Insulator dielectric strength	1,500 VDC for 1 minute, per MIL-STD 1344, Method 3001		

Regulatory Agency Evaluations

Contacts	CSA-22.2 No. 0-M91 182.30 M1987 (CNR)	UL 498 and UL 1977 (USR)
AWG #20	4A / 250V	5A / 250V
AWG #16	10A / 250V	15A / 250V
AWG #12 Top Drawer	25A / 600V	35A / 600V
AWG #12 Others	25A / 250V	35A / 250V
AWG #12 with sockets	25A / 250V	35A / 250V
Size #12 hot-plug	25A / 250V	25A / 250VAC
		35A / 120V
Size #8	55A / 250V	75A / 250V
Size #0 with single or double Crown	150A / 250V	200A / 250V
Size #0 using bus bar	—	200A / 250V
Size #4	100A / 250V	125A / 250V

ELCON Drawer Series Connectors

- Dimensions** —
2.99" x 0.79" (75.9 x 20.1 mm)
- Housing Variations** — See Part Numbers
- Guides and Polarization** — Built in
- Available Contacts** —
Size 12 / 16 x 6 contacts
Size 20 x 16 contacts
- Current Rating** — Up to 35 Amps per size 12 contact
- Contact Features** — Hot-Plug size 12 contact option
- Contact Sequencing** — Multi-level for power and signal
- Contact Terminations** —
Size 12: Crimp and PCB tail
Size 16: Crimp and PCB tail
Size 20: Crimp and PCB tail

Mini Drawer

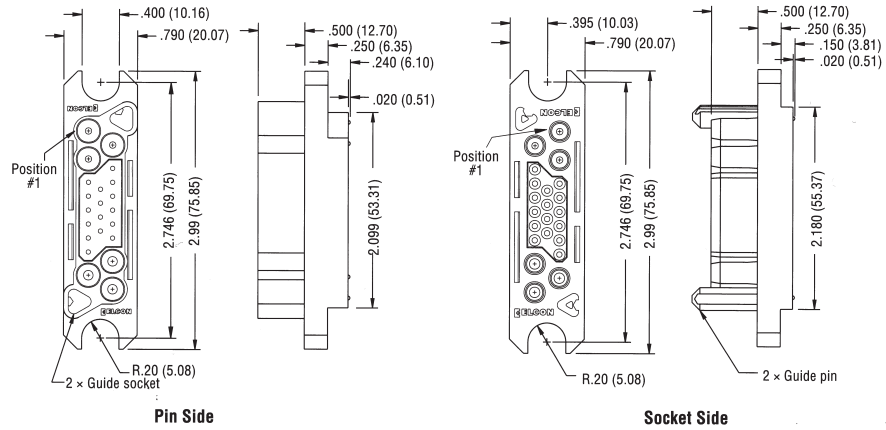

Base Housing Part Numbers

Pin Housing		Socket Housing	
1648110-1	Size 12 + Size 20 + Size 12	1648115-1	Size 12 + Size 20 + Size 12
1648111-1	Size 16 + Size 20 + Size 16	1648116-1	Size 16 + Size 20 + Size 16
1648112-1	Size 12 + Size 20 + Size 16	1648117-1	Size 12 + Size 20 + Size 16

Lower Drawer

- Dimensions** —
3.26" x 1.34" (82.8 x 34.0 mm)
- Housing Variations** — See Part Numbers
- Guides and Polarization** — Built in
- Available Contacts** —
Size 12 / 16 x 8 contacts
Size 20 x 21 contacts
- Current Rating** — Up to 35 Amps per size 12 contact
- Contact Features** — Hot-Plug size 12 contact option
- Contact Sequencing** — Multi-level for power and signal
- Contact Terminations** —
Size 12: Crimp and PCB tail
Size 16: Crimp and PCB tail
Size 20: Crimp and PCB tail

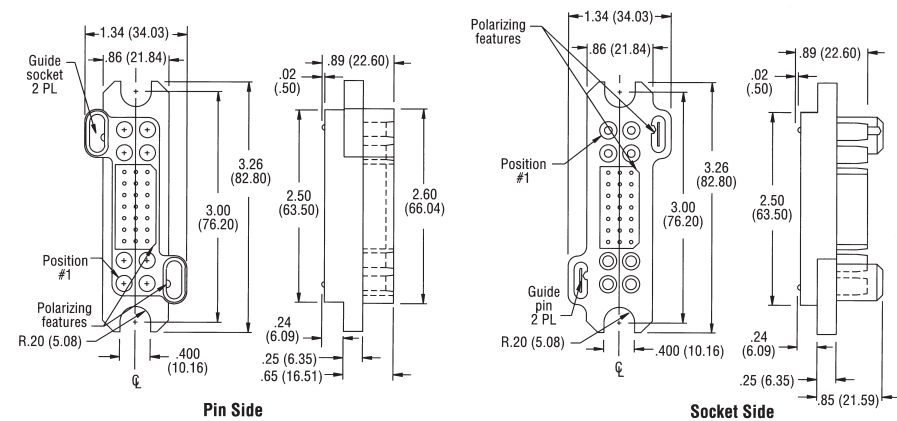

Base Housing Part Numbers

Pin Housing		Socket Housing	
1648203-1	Size 12 + Size 20 + Size 12	1648206-1	Size 12 + Size 20 + Size 12
1648204-1	Size 16 + Size 20 + Size 16	1648207-1	Size 16 + Size 20 + Size 16
1648205-1	Size 12 + Size 20 + Size 16	1648208-1	Size 12 + Size 20 + Size 16

Note: All part numbers are RoHS compliant.

ELCON Drawer Series Connectors (Continued)

75A Middle Drawer

- Dimensions** —
3.31" x 1.31" (84.1 x 33.3 mm)
- Housing Variations** — See Part Numbers
- Guides and Polarization** — Built in
- Available Contacts** —
Size 8 x 4 contacts
Size 12 x 9 contacts
Size 20 x 24 contacts
- Current Rating** — Up to 75 Amps per size 8 contact
- Contact Features** — Hot-Plug size 12 contact option
- Contact Sequencing** — Multi-level for power and signal
- Contact Terminations** —
Size 8: Crimp, internal/external thread and PCB tail
Size 12: Crimp and PCB tail
Size 20: Crimp and PCB tail

Cable Mounted Products

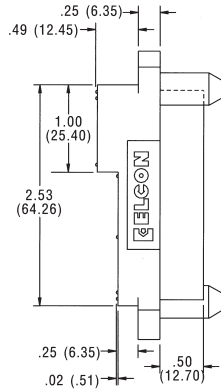
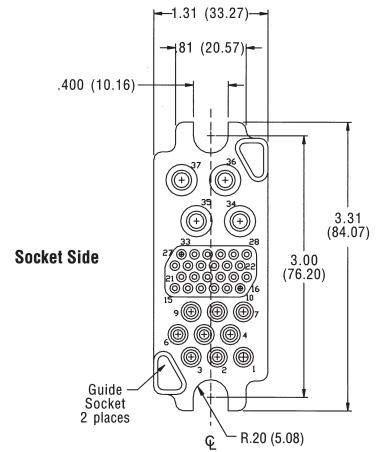
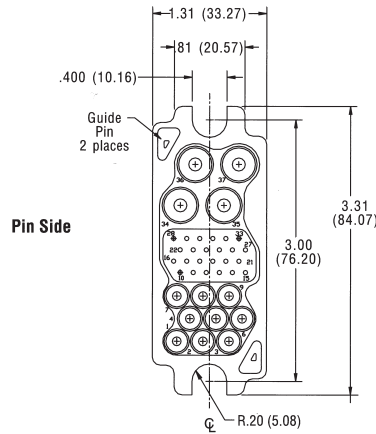

Float-Mount
Part Number 1648162-1

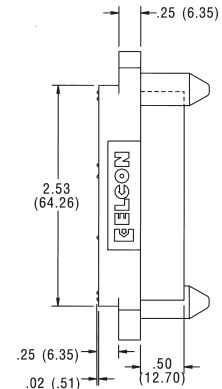

PCB-Mount
Part Number 1648163-1

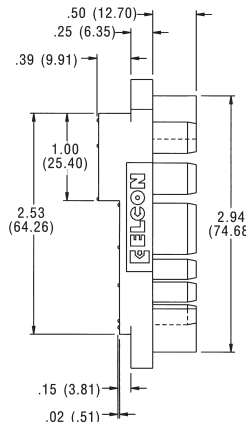

Float-Mount
Part Number 6648167-1

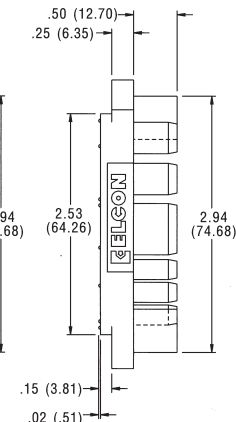

PCB-Mount
Part Number 1648168-1

Base Housing Part Numbers

Pin Housing		Socket Housing	
1648162-1	Float-Mount	6648167-1	Float-Mount w/ reinforced housing
1648163-1	PCB-Mount	1648168-1	PCB-Mount

Note: All part numbers are RoHS compliant.

ELCON Drawer Series Connectors (Continued)

125A Middle Drawer

Dimensions —

3.15" x 1.31" (80.0 x 33.3 mm)

Housing Variations — See Part Numbers

Guides and Polarization — Built in

Available Contacts —

Size 4 x 2 contacts

Size 12 x 6 contacts

Size 20 x 32 contacts

Current Rating — Up to 125 Amps per size 4 contact

Contact Features — Hot-Plug size 12 contact option

Contact Sequencing — Multi-level for power and signal

Contact Terminations —

Size 4: Crimp and internal/external thread

Size 12: Crimp and PCB tail

Size 20: Crimp and PCB tail

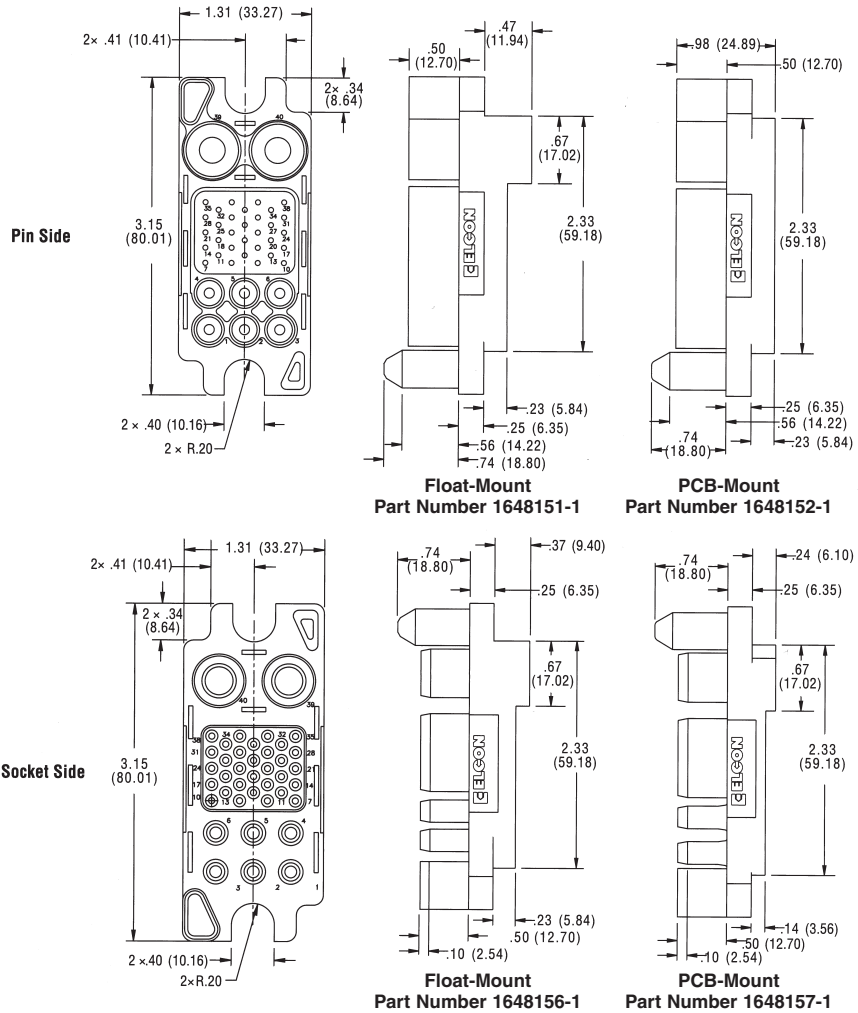

Base Housing Part Numbers

Pin Housing		Socket Housing	
1648151-1	Float-Mount	1648156-1	Float-Mount
1648152-1	PCB-Mount	1648157-1	PCB-Mount

Note: All part numbers are RoHS compliant.

ELCON Drawer Series Connectors (Continued)

200A Middle Drawer

Dimensions —

3.31" x 1.31" (84.1 x 33.3 mm)

Housing Variations — See Part Numbers

Guides and Polarization — Built in

Available Contacts —

Size 4 x 2 contacts

Size 8 x 6 contacts

Size 12 x 3 contacts

Size 20 x 14 contacts

Current Rating — Up to 125 Amps per size 4 contact

Contact Features — Hot-Plug size 12 contact option

Contact Sequencing — Multi-level for power and signal

Contact Terminations —

Size 4: Crimp and internal/external thread

Size 8: Crimp, internal/external thread and PCB tail

Size 12: Crimp and PCB tail

Size 20: Crimp and PCB tail

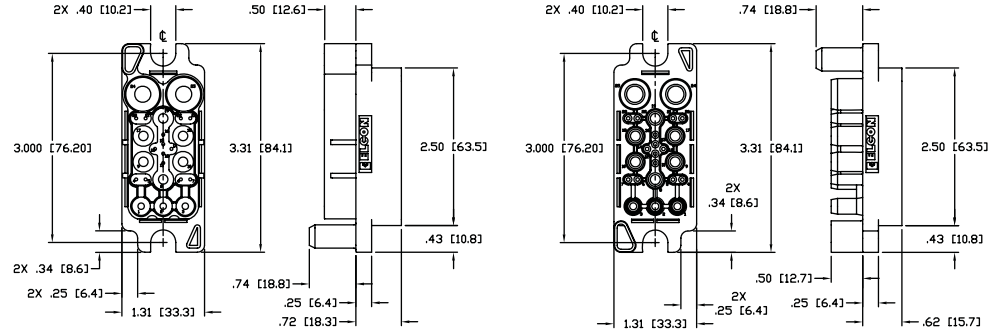

Base Housing Part Numbers

Pin Housing	Socket Housing
1648134-1	1648135-1

Square Drawer

Dimensions —

2.76" x 1.24" (70.1 x 31.5 mm)

Housing Variations — See Part Numbers

Guides and Polarization — Built in

Available Contacts —

Size 12 x 4 contacts

Size 20 x 36 contacts

Current Rating — Up to 35 Amps per size 12 contact

Contact Features — Hot-Plug size 12 contact option

Contact Sequencing — Multi-level for power and signal

Contact Terminations —

Size 12: Crimp and PCB tail

Size 20: Crimp and PCB tail

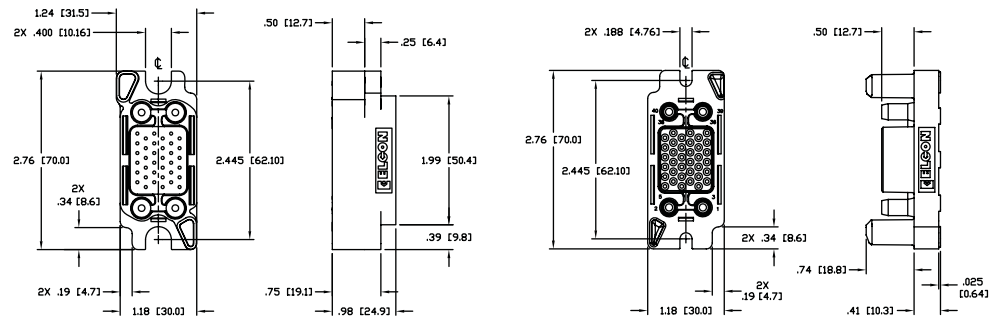

Base Housing Part Numbers

Pin Housing	Socket Housing
1648132-1	1648133-1

Note: All part numbers are RoHS compliant.

ELCON Drawer Series Connectors (Continued)

Top Drawer

Dimensions —

4.24" x 1.60" (107.8 x 40.7 mm)

Housing Variations — Various guide pin configurations available.

Guides and Polarization — Optional Steel Guide Pins with either #6-32 or M3 internal thread

Available Contacts —

- Size 0 x 2 contacts
- Size 12 x 6 contacts
- Size 16 x 12 contacts
- Size 20 x 32 contacts

Current Rating — Up to 200 Amps per size 0 contact

Contact Features — Hot-Plug size 12 contact option

Probe-proof size 0 contact option

Contact Sequencing — Multi-level for power and signal

Contact Terminations —

- Size 0: Crimp and internal/external thread
- Size 12: Crimp and PCB tail
- Size 16: Crimp and PCB tail
- Size 20: Crimp and PCB tail

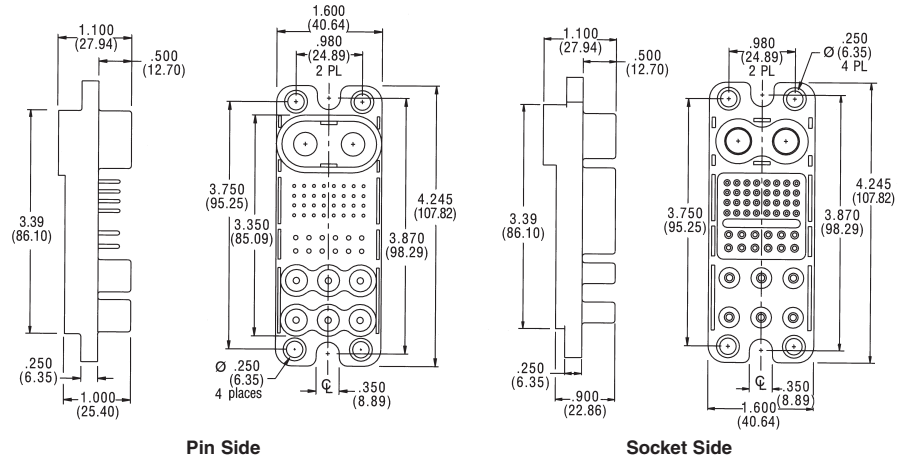

Pin Side

Socket Side

Base Housing Part Numbers

Pin Housing	Socket Housing
1648183-1	1648186-1

Optional guide posts are available for improved alignment. Consult Customer Service for details.

Double Drawer

Dimensions — 4.24" x 1.60" (107.8 x 40.7 mm)

Housing Variations — Various guide pin configurations available.

Guides and Polarization — Optional Steel Guide Pins with either #6-32 or M3 internal thread

Available Contacts —

- Size 0 x 4 contacts
- Size 12 x 11 contacts
- Size 20 x 24 contacts

Current Rating — Up to 200 Amps per size 0 contact

Contact Features — Hot-Plug size 12 contact option

Probe-proof size 0 contact option

Contact Sequencing — Multi-level for power and signal

Contact Terminations —

- Size 0: Crimp and internal/external thread
- Size 12: Crimp and PCB tail
- Size 20: Crimp and PCB tail

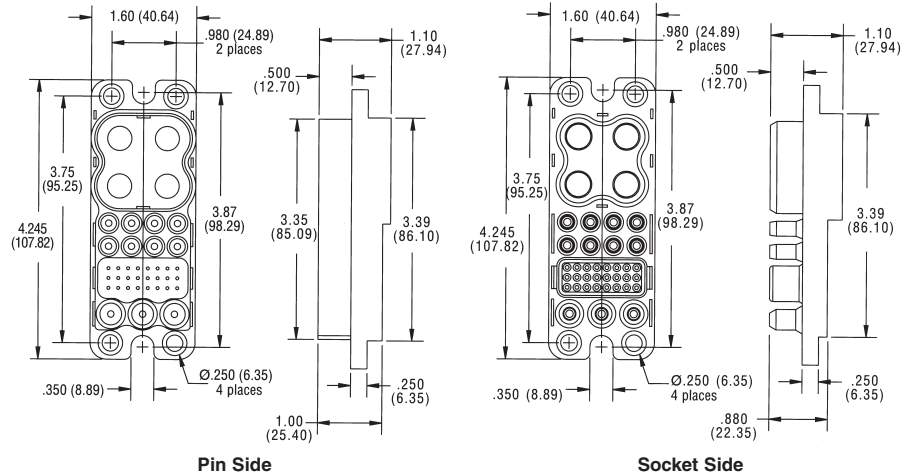

Pin Side

Socket Side

Base Housing Part Numbers

Pin Housing	Socket Housing
1648552-1	1648578-1

Optional guide posts are available for improved alignment. Consult Customer Service for details.

Note: All part numbers are RoHS compliant.

ELCON Drawer Series Connectors (Continued)

DualPower Drawer

Dimensions —

1.80" x 1.60" (45.7 x 40.7 mm)

Housing Variations — Various guide pin configurations available.

Guides and Polarization —

Optional Steel Guide Pins with either #6-32 or M3 internal thread

Available Contacts — Size 0 x 2 contacts

Current Rating — Up to 200 Amps per contact

Contact Features — Probe-proof size 0 contact option

Contact Sequencing — Standard only

Contact Terminations —

Size 0: Crimp and internal/external thread

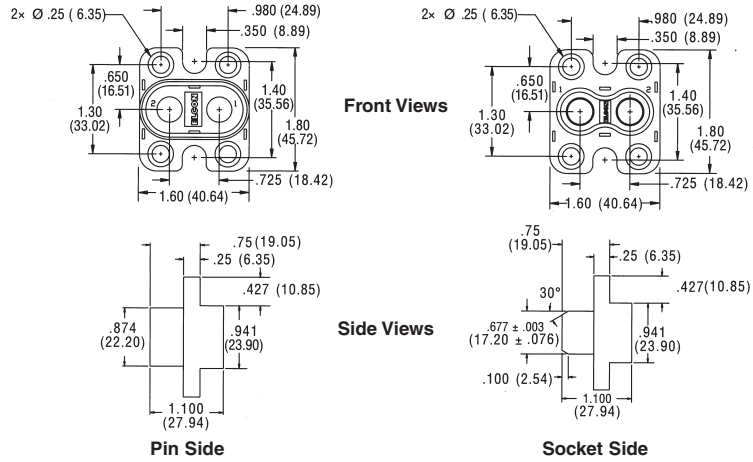

Base Housing Part Numbers

Pin Housing	Socket Housing
1648549-1	1648575-1

Optional guide posts are available for improved alignment. Consult Customer Service for details.

QuadPower Drawer

Dimensions —

2.50" x 1.60" (63.5 x 40.7 mm)

Housing Variations — Various guide pin configurations available.

Guides and Polarization —

Optional Steel Guide Pins with either #6-32 or M3 internal thread

Available Contacts — Size 0 x 4 contacts

Current Rating — Up to 200 Amps per contact

Contact Features — Probe-proof size 0 contact option

Contact Sequencing — Standard only

Contact Terminations —

Size 0: Crimp and internal/external thread

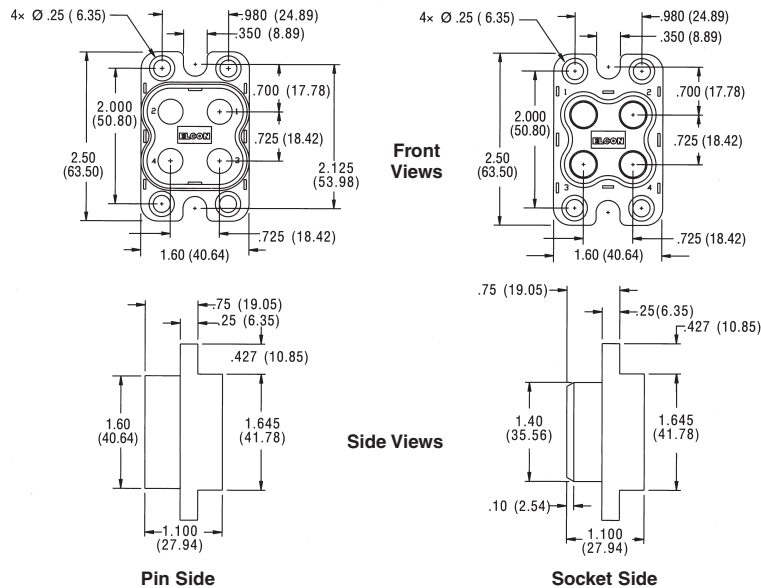

Base Housing Part Numbers

Pin Housing	Socket Housing
1648548-1	1648574-1

Optional guide posts are available for improved alignment. Consult Customer Service for details.

Note: All part numbers are RoHS compliant.

ELCON Drawer Series Connectors (Continued)

Dimensions —
4.84" x 1.21" (122.8 x 30.7 mm)
Housing Variations — See Part Numbers
Guides and Polarization — Built in
Available Contacts — Size 0 x 4 contacts
Current Rating — Up to 200 Amps per contact
Contact Features — Probe-proof size 0 contact option
Contact Sequencing — Standard only
Contact Terminations —
Size 0: Crimp and internal/external thread

In-Line QuadPower Drawer

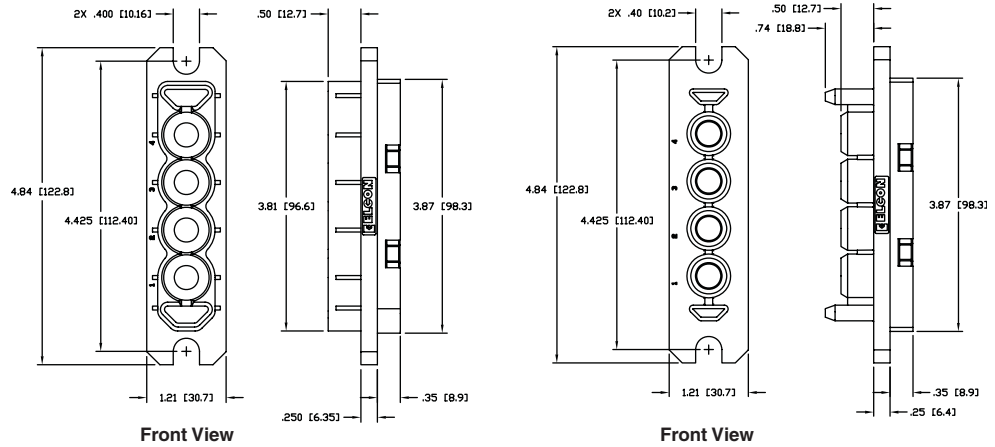

Base Housing Part Numbers

Pin Housing	Socket Housing
6651493-1	6651494-1

Dimensions —
3.00" x 1.18" (76.2 x 30.0 mm)
Housing Variations — See Part Numbers
Guides and Polarization — Built in
Available Contacts — Size 4 x 5 contacts
Current Rating — Up to 100 Amps per contact
Contact Features — Probe-proof size 0 contact option
Contact Sequencing — Standard only
Contact Terminations —
Size 4: Crimp and internal/external thread

W5 Power Drawer

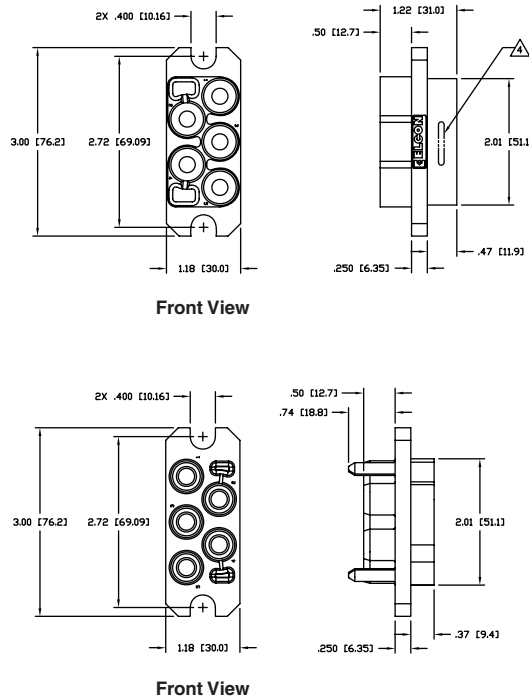

Base Housing Part Numbers

Pin Housing	Socket Housing
6651457-1	6651458-1

Note: All part numbers are RoHS compliant.

ELCON Drawer Series Connectors (Continued)

P3S0 Drawer

Dimensions —

0.99" x 0.95" (25.0 x 24.0 mm)

Housing Variations — See Part Numbers

Cable Socket to Panel-Mount Pin

Guides and Polarization — Polarization only

Available Contacts — Size 12 x 3 contacts

Current Rating — Up to 35 Amps per size 12 contact

Contact Features — Hot-Plug size 12 contact option

Contact Sequencing — Multi-level for power

Contact Terminations — Size 12: Crimp only

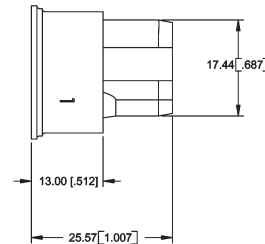
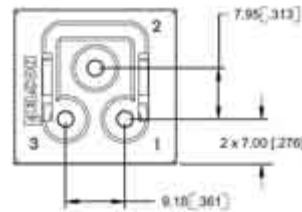
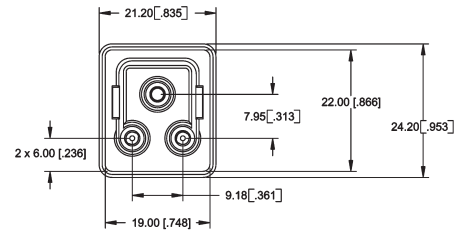
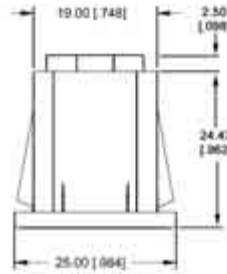

Base Housing Part Numbers

Pin Housing	Socket Housing
1766447-1	1766448-1

P4S0 Drawer

Dimensions —

1.34" x 0.76" (34.0 x 19.4 mm)

Housing Variations — See Part Numbers

Cable Pin to PCB-Mount Socket

Guides and Polarization — Polarization only

Available Contacts — Size 12 x 4 contacts

Current Rating — Up to 35 Amps per size 12 contact

Contact Sequencing — Standard only

Contact Terminations — Size 12: Crimp Pin and PCB tail Socket

Note: Supplied as kit, including contacts

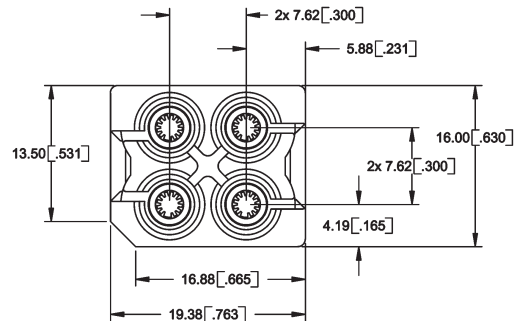
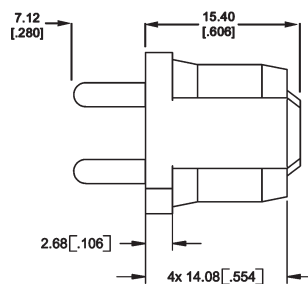
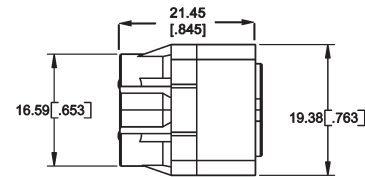
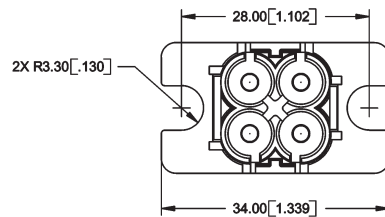

Base Housing Part Numbers

Pin Side Kit	Socket Side Kit
6766014-1	6766015-1

Note: All part numbers are RoHS compliant.

ELCON Drawer Series Connectors (Continued)

HV8P Drawer

- Dimensions** — 2.50" x 1.11" (63.5 x 28.2 mm)
- Housing Variations** — See Part Numbers
- 600 V High Voltage Design
- Guides and Polarization** — Built in
- Available Contacts** — Size 12 x 8 contacts
- Current Rating** — Up to 35 Amps per size 12 contact
- Contact Features** — Hot-Plug size 12 contact option
- Contact Sequencing** — Multi-level for power
- Contact Terminations** — Size 12: Crimp and PCB tail

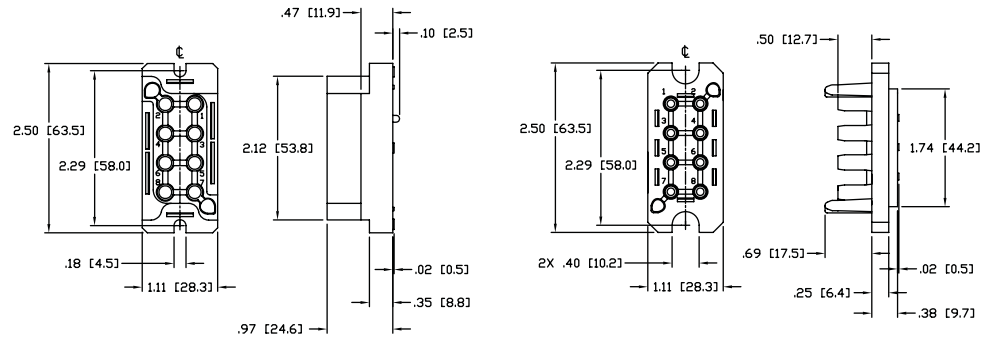

Base Housing Part Numbers

Pin Housing	Socket Housing
1648127-1	1648128-1

P10S0 Drawer

- Dimensions** — 2.96" x 1.00" (75.0 x 25.4 mm)
- Housing Variations** — See Part Numbers
- Guides and Polarization** — Built in
- Available Contacts** — Size 12 x 10 contacts
- Current Rating** — Up to 35 Amps per size 12 contact
- Contact Features** — Hot-Plug size 12 contact option
- Contact Sequencing** — Multi-level for power
- Contact Terminations** — Size 12: Crimp and PCB tail

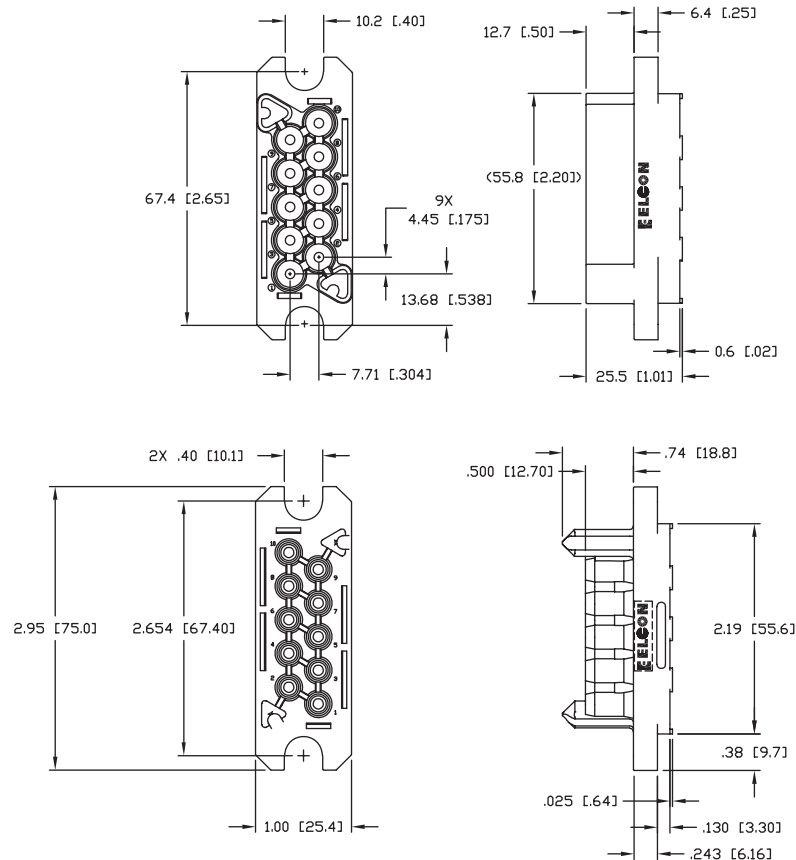

Base Housing Part Numbers

Pin Housing	Socket Housing
1648568-1	1648596-1

Note: All part numbers are RoHS compliant.

ELCON Drawer Series Connectors (Continued)

P6S18 Drawer

- Dimensions** —
5.45" x 1.35" (138.4 x 34.3 mm)
- Housing Variations** — See Part Numbers
- Guides and Polarization** — Built in
- Available Contacts** —
Size 4 x 6 contacts
Size 20 x 18 contacts
- Current Rating** — Up to 100 Amps per size 4 contact
- Contact Features** — Standard
- Contact Sequencing** — Multi-level for power and signal
- Contact Terminations** —
Size 4: Crimp and internal/external thread
Size 20: Crimp and PCB tail

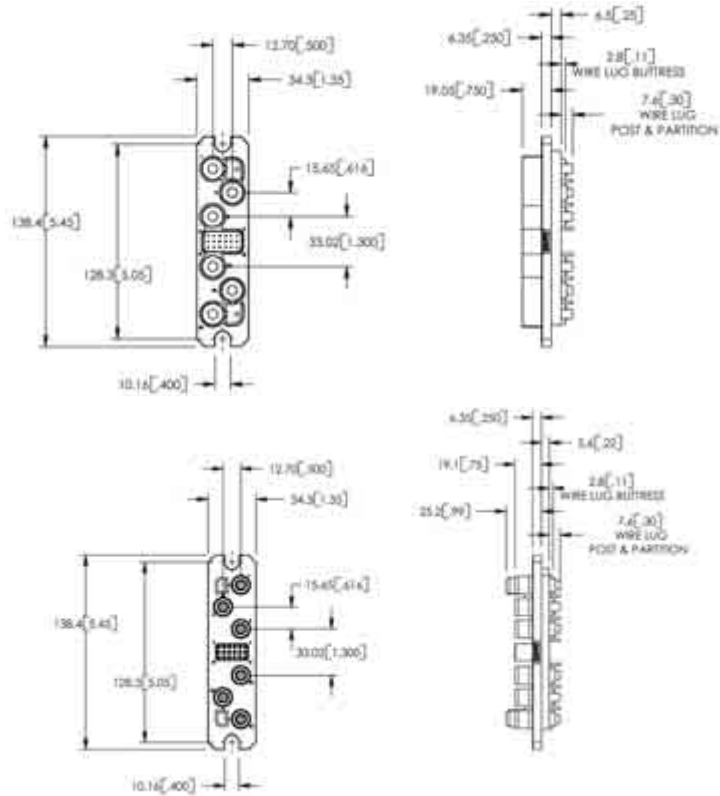

Base Housing Part Numbers

Pin Housing	Socket Housing
6766615-1	6651810-1

P10S22 Drawer

- Dimensions** —
4.12" x 0.79" (104.5 x 20.1 mm)
- Housing Variations** — See Part Numbers
- Guides and Polarization** — Built in
- Available Contacts** —
Size 12 x 10 contacts
Size 20 x 22 contacts
- Current Rating** — Up to 35 Amps per size 12 contact
- Contact Features** — Hot-Plug size 12 contact option
- Contact Sequencing** — Multi-level for power and signal
- Contact Terminations** —
Size 12: Crimp and PCB tail
Size 20: Crimp and PCB tail

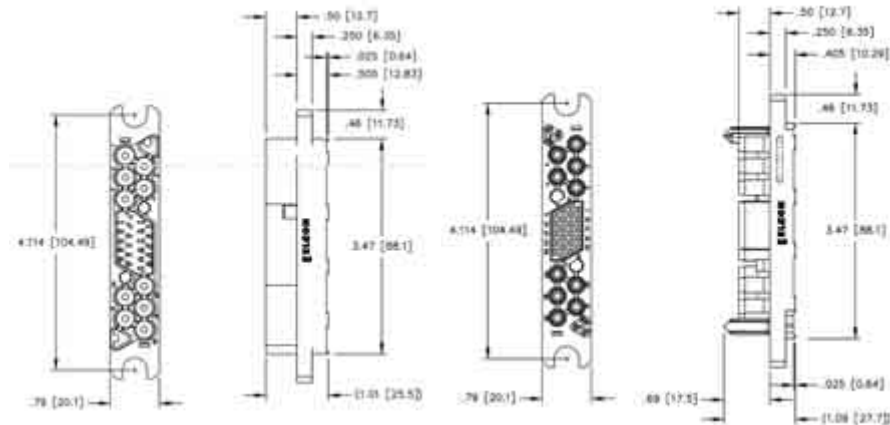

Base Housing Part Numbers

Pin Housing	Socket Housing
1648211-1	1648212-1

Note: All part numbers are RoHS compliant.

ELCON Drawer Series Connectors (Continued)

Cable Mounted Products

- Dimensions** —
4.31" x 0.70" (109.5 x 17.8 mm)
- Housing Variations** — See Part Numbers
- Guides and Polarization** — Built in
- Available Contacts** —
Size 16 x 12 contacts
Size 20 x 12 contacts
- Current Rating** — Up to 15 Amps per size 16 contact
- Contact Features** — Standard only
- Contact Sequencing** — Multi-level for power and signal
- Contact Terminations** —
Size 16: Crimp and PCB tail
Size 20: Crimp and PCB tail

P12S12 Drawer

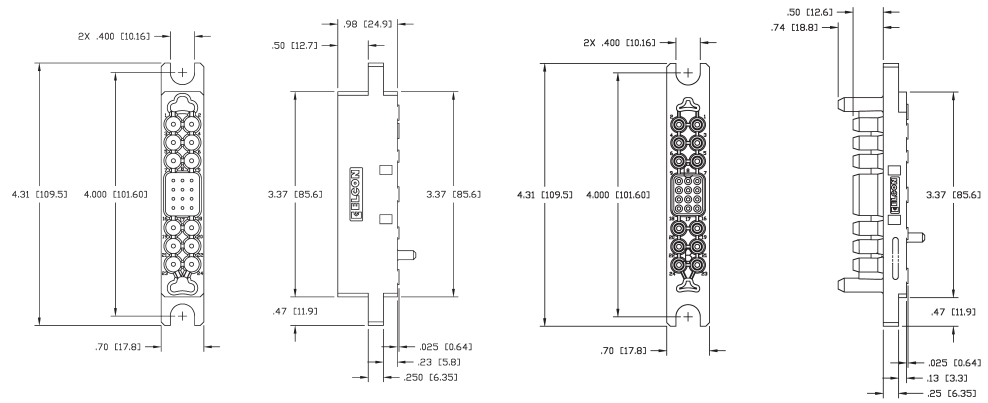

Base Housing Part Numbers

Pin Housing	Socket Housing
1651202-1	1651203-1

- Dimensions** —
3.22" x 0.70" (81.8 x 17.8 mm)
- Housing Variations** — See Part Numbers
- Guides and Polarization** — Built in
- Available Contacts** — Size 20 x 30 contacts
- Current Rating** — Up to 5 Amps per size 20 contact
- Contact Features** — Standard only
- Contact Sequencing** — Multi-level for signal
- Contact Terminations** —
Size 20: Crimp and PCB tail

POS30 Drawer

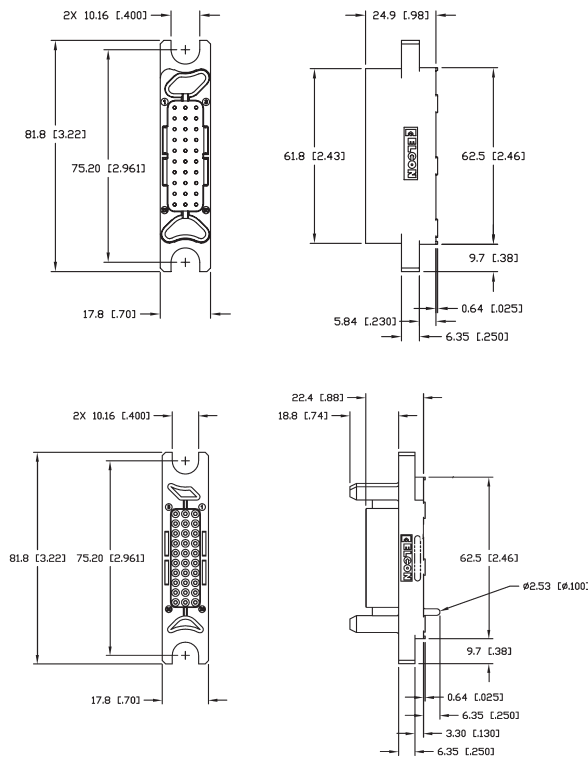

Base Housing Part Numbers

Pin Housing	Socket Housing
6651204-1	6651205-1

Note: All part numbers are RoHS compliant.

ELCON Drawer Standard Contacts

The ELCON drawer series connectors use standard contacts across the product line. This section shows the standard contacts available in different sizes and various lengths and termination styles, with their respective part numbers.

Pin Side Contacts

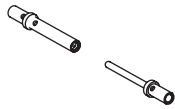

Contact Size #20

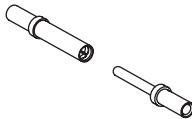

Contact Size #16

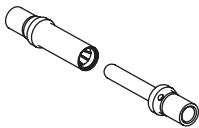

Contact Size #12

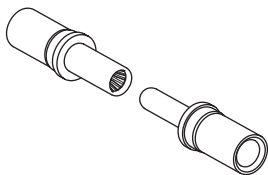

Contact Size #8

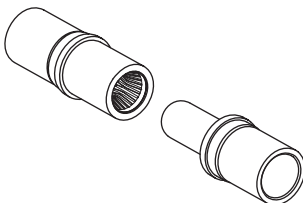

Contact Size #4

Note: All part numbers are RoHS compliant.

Contact Size #20 — For use in most drawer connectors

Termination Type	Contact Part Number	Dimensions	A	
			in	mm
Crimp, standard	1650155-1		0.32	[8.12]
Crimp, premate	1650161-1		0.47	[11.93]
Crimp, postmate	1650162-2		0.27	[6.85]
PCB tail, standard	1650283-1		0.32	[8.12]
PCB tail, premate	1650065-1		0.47	[11.93]
PCB tail, postmate	1650226-1		0.27	[6.85]

Contact Size #16 — For use in Mini Drawer, Lower Drawer, Top Drawer, and P12S12

Termination Type	Contact Part Number	Dimensions	A	
			in	mm
Crimp, standard	1766194-1		0.33	[8.38]
Crimp, premate	1766198-1		0.48	[12.19]
Crimp, postmate	1766199-1		0.29	[7.36]
PCB tail, standard	1766222-1		0.33	[8.38]
PCB tail, premate	1766223-1		0.48	[12.19]
PCB tail, postmate	1766818-1		0.29	[7.36]

Contact Size #12 — For use in Mini Drawer, Lower Drawer, 75A, 125A and 200A Middle Drawer; Square Drawer, TOP Drawer & Double Drawer; P3S0 and P4S0, HV8P, P10S0, P10S22

Termination Type	Contact Part Number		Dimensions	A	
	Gold Plated	Silver Plated		in	mm
Crimp, standard	1650153-2	1766193-1		0.43	[10.92]
Crimp, premate	1650156-2	1766195-1		0.46	[11.68]
Crimp, postmate	1650158-2	1766196-1		0.39	[9.90]
PCB tail, standard	1650060-2	1766245-1		0.43	[10.92]
PCB tail, premate	1650074-3	1766250-1		0.46	[11.68]
PCB tail, postmate	1650073-3	1766249-1		0.39	[9.90]

Note: For applications using the #12 hot-plug socket use of gold plated pins are recommended.

Contact Size #8 - For use in 75A and 200 A Middle Drawer

Termination Type	Contact Part Number	Dimensions	A	
			in	mm
Crimp, standard	1766192-1		0.43	[10.92]
Crimp, premate	1766197-1		0.48	[12.19]
Crimp, postmate	1766821-1		0.33	[8.38]
PCB tail, standard	1766262-1		0.43	[10.92]
PCB tail, premate	1766263-1		0.48	[12.19]

Contact Size #4 - For use in 125A and 200A Middle Drawer. P6S18 Drawer, W5 Power Drawer

Termination Type	Contact Part Number	Dimensions	A	
			in	mm
Crimp, Standard	1766232-1		0.51	[12.95]
1/4 - 20 x .050 DP External Thread	1766812-1		0.51	[12.95]
M5 x 0.8 x 9.6 mm DP M5 Internal Thread	1766283-1		0.51	[12.95]

ELCON Drawer Standard Contacts (Continued)

Pin Side Contacts (Continued)

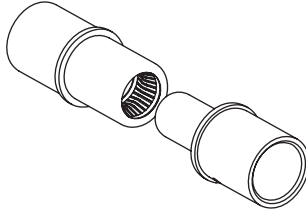

Contact Size #0

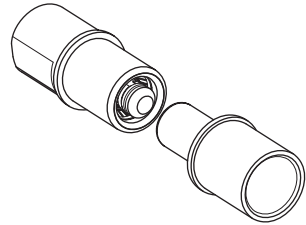

**Contact Size #0
Probe-proof**

Contact Size #0¹ - For use in Top Drawer, Double Drawer, DualPower & QuadPower, In-Line QuadPower

Termination Type	Contact Part Number	Dimensions	A	
			in	mm
Crimp	1766811-1		0.495	[12.57]
Probe-proof crimp ²	1766819-1		0.430	[10.92]
1/4 - 20 x .050 DP Internal thread	1766230-1		0.495	[12.57]
M6 x 1 x 12.7 mm DP Internal thread	1766274-1		0.495	[12.57]
1/4 - 20 x .050 DP Probe-proof/internal thread ²	1766269-1		0.430	[10.92]
M6 x 1 x 12.7 mm DP Probe-proof/Internal thread ²	1766275-1		0.430	[10.92]
1/4 - 20 x .050 DP External thread	1766268-1		0.495	[12.57]
M6 x 1 x 12.7 mm DP External thread	1766231-1		0.495	[12.57]
1/4 - 20 x .050 DP Probe-proof/external thread ²	1766270-1		0.430	[10.92]
M6 x 1 x 12.7 mm DP Probe-proof/external thread ²	1766276-1		0.430	[10.92]

Notes: ¹Contact Tyco Electronics for alternate contact terminations.
²Use only with probe-proof socket contacts.
³Crimp and threaded contact are insertable/removable.

Socket Side Contacts

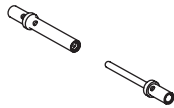

Contact Size #20

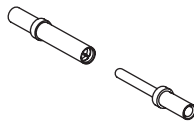

Contact Size #16

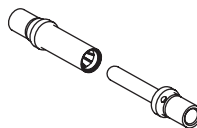

Contact Size #12

Contact Size #20

Termination Type	Contact Part Number
Crimp	1648325-1
PCB Tail	1648382-1

Contact Size #16

Termination Type	Contact Part Number
Crimp	6648319-1
PCB Tail	6648383-1

Contact Size #12

Termination Type	Contact Part Number
Crimp	6648318-1
Hot-Plug Crimp	1648384-1
PCB Tail	6648374-1
Hot-Plug PCB Tail	1648387-1

Note: For applications using the #12 hot-plug socket, the use of gold plated pins are recommended (see page 80).

Note: All part numbers are RoHS compliant.

ELCON Drawer Standard Contacts (Continued)

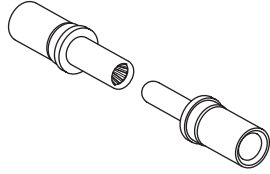
Socket Side Contacts

Contact Size #8
Contact Size #8

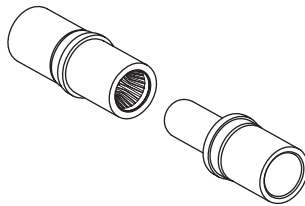
Termination Type	Contact Part Number
Crimp	6648317-1
PCB Tail	6648400-1

Contact Size #4
Contact Size #4

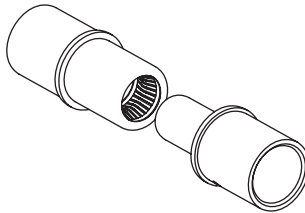
Termination Type	Contact Part Number
Crimp, Standard	6648434-1
1/4 - 20 x .050 DP External Thread	6648435-1
M5 x 0.8 x 9.6 mm DP M5 Internal Thread	6648335-1

Contact Size #0
Contact Size #0¹

Termination Type	Contact Part Number
Crimp	6648405-1
Probe-proof crimp ²	6648418-1
1/4 - 20 x .050 DP Internal thread	6648416-1
M6 x 1 x 12.7 mm DP Internal thread	6648428-1
1/4 - 20 x .050 DP Probe-proof/internal thread ²	6648419-1
M6 x 1 x 12.7 mm DP Probe-proof/Internal thread ²	6648429-1
1/4 - 20 x .050 DP External thread	6648417-1
M6 x 1 x 12.7 mm DP External thread	6648430-1
1/4 - 20 x .050 DP Probe-proof/external thread ²	6648420-1
M6 x 1 x 12.7 mm DP Probe-proof/external thread ²	6648431-1

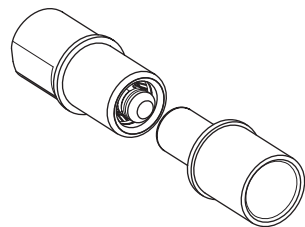
Contact Size #0 Probe-proof

Notes: ¹Contact Tyco Electronics for alternate contact terminations.
²Use only with probe-proof Pin contacts.
³Crimp and threaded contact are insertable/removable.

Non-Standard Contacts

Contacts with pin lengths and terminations other than standard are available. Consult customer service if your design requires contacts different from the ones shown in this catalog.

Note: All part numbers are RoHS compliant.

AMP Miniature Power Drawer (MPD) Connectors

Product Facts

- High mating cycle life
- Low Mating and Un-mating force (< 0.2lbs per contact)
- Single-piece molded housing
- Molded-in guide pins provide generous blind-mateability
- Sizes: 3 – 10 positions
- Compact size is ideal for distributed DC power applications
- Two Levels of contact sequencing
- One contact for either solder or press-fit termination
- Hardware — Less or traditional shoulder bolt mounting
- Minimum of 3 mm contact wipe on shortest power contact
- All MPD connectors in this section are RoHS compliant

Specifications

Up to 16 Amps per contact
 250 mating cycle durability
 +/- 1.25 mm radial mis-alignment capability. (Total float is 2.5 mm!)
 1.6 mm sequencing distance — ideal for modular sheet metal construction applications
 Minimum of 3 mm contact wipe on shortest power contact
 Maximum continuous operating temperature — 105°C
 UL 94 V-0 High-temperature thermoplastic housings

Technical Documents

Product Specification

108-1998

Application Specification

114-13067

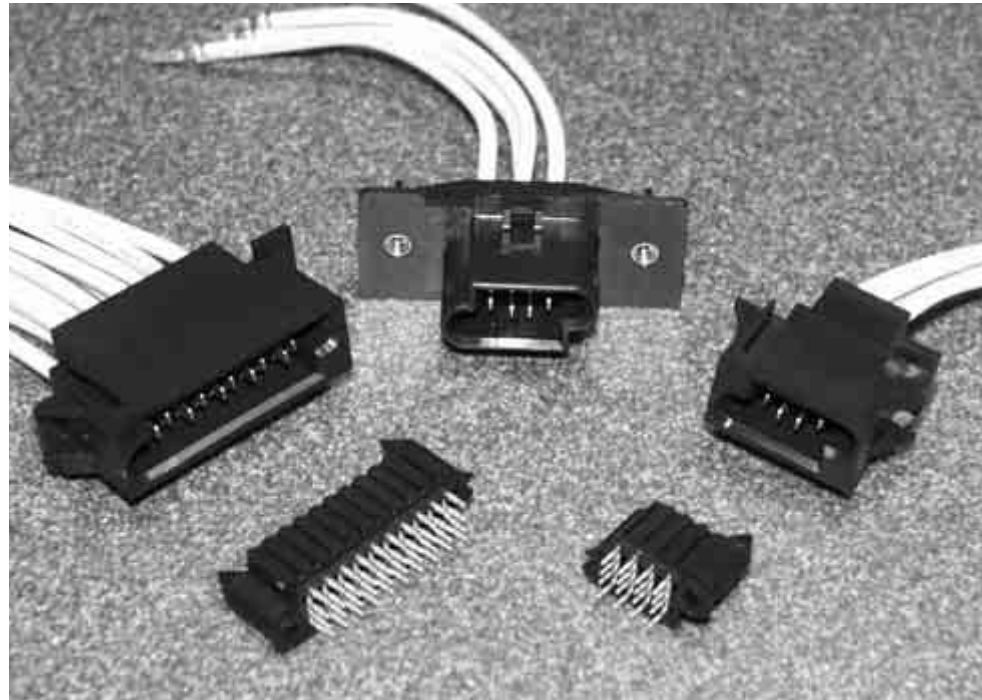

The miniature power drawer connector combines a high density power interface in a blind-mateable wire-to-board connector. The MPD contact interface has been previously qualified to requirements similar to BellCore GR-1217 in board-to-board applications. Now available in a crimp-to-wire version, the contacts are rated for up to 15 Amps on 14 AWG wire. In addition, the MPD contacts are designed to meet UL 1977 hot-plug requirements for up to 7.8 Amps at 48VDC.

The connection consists of a vertical pcb mountable receptacle and a panel-mounted floating plug. The vertical receptacle pcb tails are designed for use in either through hole solder or press-fit applications. The float-mount plug is easily installed from the inside of the chassis without any additional hardware, lending itself to easy assembly of pre-made cable assemblies. Additionally, the staggered wire exit pattern permits the maximum number of contact interfaces in the least amount of connector volume.

The compact design is ideal for bringing power to small rack-mounted devices such as 1U computer servers and telecommunications switches. The 3 mm center-line satisfies UL 1977 safety requirements for 48 VDC distributed power applications. For higher voltage applications such as AC input, the contacts can be selectively loaded to handle up to 300 V AC or DC.

AMP Miniature Power Drawer (MPD) Connectors (Continued)

Crimp Contacts

Current Ratings

Standard Power — 10 Amps

High Power — 16 Amps

Material and Finish

Standard Power:

Crimp Blade Contacts — Brass

Receptacle Contacts —
Phos. Bronze.

Finish — 0.38µm Gold over 1.27µm Nickel

High Power:

Blades — High Conductivity Cu Alloy

Receptacle — High Conductivity Cu Alloy

Finish — 1.27µm Gold over 1.27µm Nickel

Contact Mating Length (Min.) —

Type A — 4.6 mm

Type B — 3.0 mm

Hot-Pluggability (With High Current Contacts only) —

250 Cycles — 7.8 Amps @ 48VDC

Note: All contacts are Sn plated in the crimp barrel or Sn in pcb interface

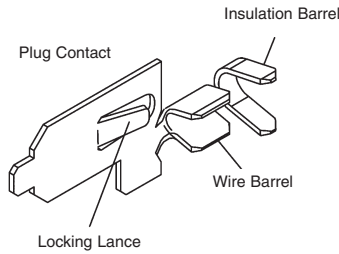

PRO-CRIMPER Hand Tool
Part Number 91363-1

Crimp Blade Contacts

Wire Size	Type	Cycles	Mating Length	Part Number Strip Form	Applicator	Hand Tool
16-20 AWG	Standard Power	100	A	1489128-8	1385248-3	91363-1
			B	1489128-7		
	High Power	250	A	1-1489128-0		
			B	1489128-9		

Heavy Duty Miniature (HDM) Applicator for AMP-O-LECTRIC Model G Machine - #1385248-3.
PRO-CRIMPER Hand Tool #354940-1, Die set # 91363-2

Cable Mounted Products

Plugs and Receptacles

Materials

UL 94V-0 Thermoplastic

105°C Max. Operating temperature

Note: Vertical PCB Mt. Receptacles supplied with press-fit ACTION PIN contacts.

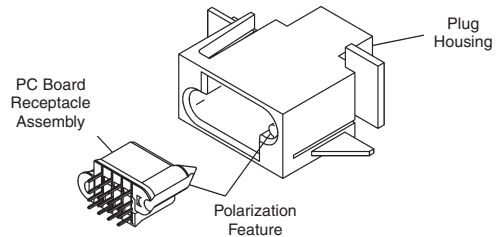
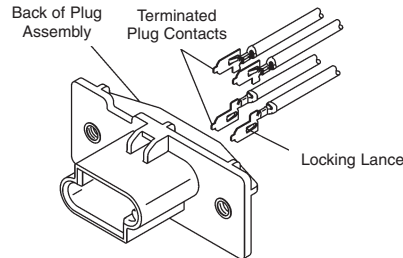

Number of Positions	Part Number			
	Panel-Mount Plug		PCB-Mount Receptacles	
	Snap-In	Shoulder Bolt	Standard Power	High Current
3	1489127-1	—	1489715-1	1-1489715-1
4	1489127-2	1489701-1	1489715-2	1-1489715-2
5	1489127-3	—	1489715-3	1-1489715-3
6	1489127-4	—	1489715-4	1-1489715-4
7	1489127-5	—	1489715-5	1-1489715-5
8	1489127-6	—	1489715-6	1-1489715-6
9	1489127-7	—	1489715-7	1-1489715-7
10	1489127-8	—	1489715-8	1-1489715-8

Note: All part numbers are RoHS compliant.

Hybrid Blind-Mate Drawer Connectors

Product Facts

- High current circuits and signal circuits can be mixed in the same connector
- High current circuits use MIC connector contacts located at four corners of the housing
- Signal circuits use Standard Drawer Connector contacts
- 24 positions
- Hermaphroditic housing can be mated with top and bottom turned while maintaining polarity

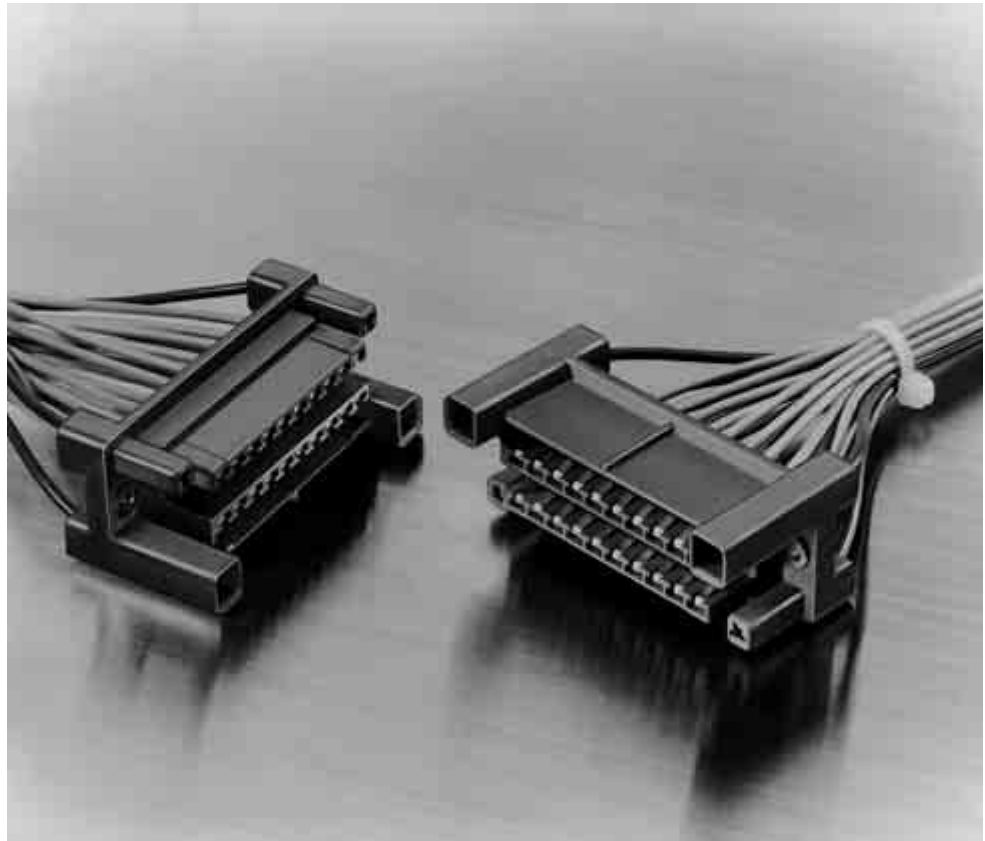

Hybrid Drawer Connectors offer high current and signal circuits mixed in the same connector system.

High current circuits use MIC connector contacts which are located at the four corners of the housing.

Signal circuits use the same

hermaphroditic crimp snap-in contacts that are used in the Standard Drawer Connector.

The hermaphroditic housings are available in a popular 24-position size. These housings can be mated with top and bottom turned while maintaining polarity.

Performance Specifications

Voltage Rating — 250 VAC

Current Rating (Max.) —

Signal Circuit (Drawer);
4 Amps — 24 AWG [0.2 mm²] Wire
5 Amps — 22 AWG [0.3-0.4 mm²] Wire
7 Amps — 20 AWG [0.5-0.6 mm²] Wire
Power Circuit (MIC);
10 Amps

Low Level Resistance —

Signal Circuit (Drawer);
10 milliohms max. (Initial)
20 milliohms max. (Final)
Power Circuit (MIC);
3 milliohms (Initial)
6 milliohms (Final)

Dielectric Withstanding Voltage —

5000 milliohms (Initial)
2000 milliohms (Final)

Operating Temperature —

-20°C to +120°C

Hybrid Blind-Mate Drawer Connectors (Continued)

**Housings
(Hermaphroditic),
24 Positions**

Material

Housing — Glass-filled polybutylene terephthalate (PBT), blue

Bushing — Brass, zinc-plated

Related Product Data

Performance Specifications — page 85

MIC Contacts — page 87

Crimp Snap-In Contacts — page 87

Technical Documents

Product Specification
108-5371

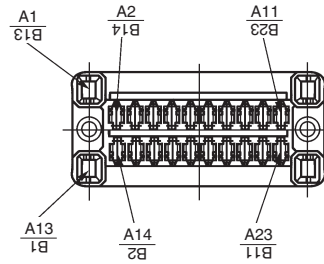
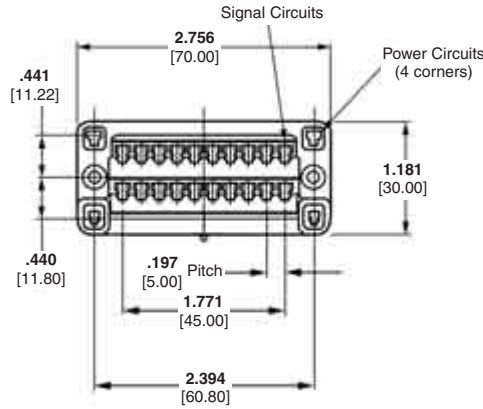

Note: Reverse figures show circuit numbers.

(Example = $\frac{A1}{81B}$ The hole used for No. 1 circuit is used for No. 13 on the reverse side.)

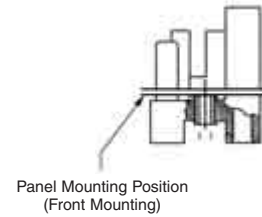
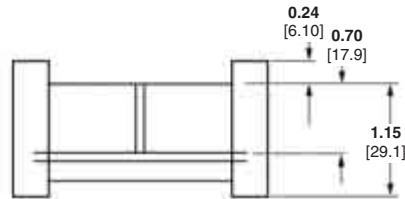

Floating of Bushing	Housing Part Numbers
Up- and downward = 0.05 [.002] Circumferential = 0.14 [.006]	5176916-1
Up- and downward = 0.30 [.012] Circumferential = 0.80 [.031]	5176916-2

Upward and downward = Axial clearance
Circumferential = Floating

Recommended Panel Cutout

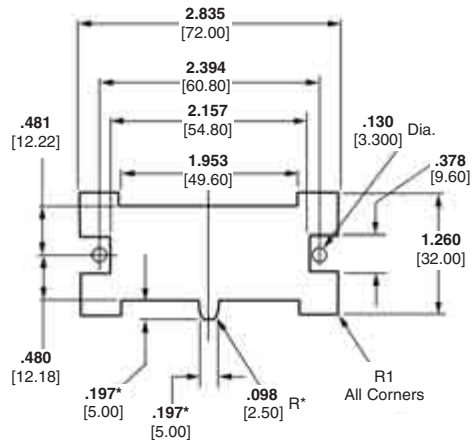

*Dimensions applicable for rear mounting.

Note: All part numbers are RoHS compliant.