



Chipsmall Limited consists of a professional team with an average of over 10 year of expertise in the distribution of electronic components. Based in Hongkong, we have already established firm and mutual-benefit business relationships with customers from,Europe,America and south Asia,supplying obsolete and hard-to-find components to meet their specific needs.

With the principle of "Quality Parts,Customers Priority,Honest Operation,and Considerate Service",our business mainly focus on the distribution of electronic components. Line cards we deal with include Microchip,ALPS,ROHM,Xilinx,Pulse,ON,Everlight and Freescale. Main products comprise IC,Modules,Potentiometer,IC Socket,Relay,Connector.Our parts cover such applications as commercial,industrial, and automotives areas.

We are looking forward to setting up business relationship with you and hope to provide you with the best service and solution. Let us make a better world for our industry!



Contact us

Tel: +86-755-8981 8866 Fax: +86-755-8427 6832

Email & Skype: info@chipsmall.com Web: www.chipsmall.com

Address: A1208, Overseas Decoration Building, #122 Zhenhua RD., Futian, Shenzhen, China



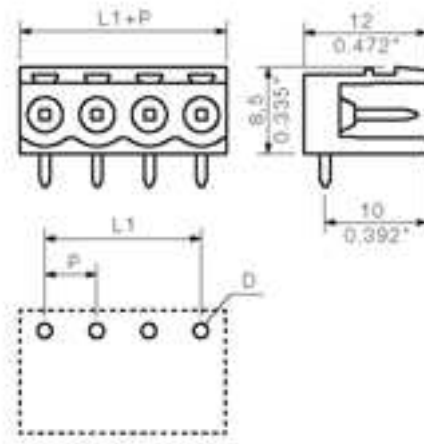

General ordering data

Order No.	1774792001
Part designation	SL-SMT5.08/5/90 1.5SN
Version	PCB plug-in connector, Male connectors, Reflow solder connection, Pitch: 5.08 mm, No. of poles: 5, 90°, Box
EAN	4032248155828
Qty.	50 pc(s).

System parameters

Fitted to PCB	Reflow solder connection
Outgoing elbow	90°
Pitch	5.08 mm
Pitch in inch	0.2 inch
No. of poles	5
Solder pin length	1.5 mm
Can be coded	Yes
No. of solder pins per pole	1
L1 in mm	20.32 mm
L1 in inch	0.8 inch

Material data

Insulating material	LCP GF
Colour	black

Material data

colour chart	Similar to RAL 9011
Insulating material group	IIIa
Flammability class UL 94	V-0
Contact base material	CuSn
Contact surface	tinned
Constant operating temp., min.	-25 °C
Constant operating temp., max.	100
Storage temperature, min.	-25 °C
Storage temperature, max.	55 °C
Max. relative humidity during storage	80 %

DIN IEC rating data

Rated current, min. No. pins (Tu=20°C)	19 A
Rated current, max. No. pins (Tu=20°C)	15 A
Rated current, min. No. pins (Tu=40°C)	16 A
Rated current, max. No. pins (Tu=40°C)	13 A
Rated voltage for overvoltage class/pollution severity III/3	250 V
Rated impulse withstand voltage for overvoltage class/pollution severity III/3	4 kV
Rated voltage for overvoltage class/pollution severity III/2	320 V
Rated impulse withstand voltage for overvoltage class/pollution severity III/2	4 kV
Rated voltage for overvoltage class/pollution severity II/2	400 V
Rated impulse withstand voltage for overvoltage class/pollution severity II/2	4 kV

CSA rating data

Rated voltage (Use group D)	300 V
Rated current (Use group D)	10 A

UL 1059 rating data

Rated voltage (Use group D)	300 V
Rated current (Use group D)	10 A

Approvals

Approvals institutes



Classifications

ETIM 2.0	NK
ETIM 3.0	EC001284
eClass 4.1	27-26-07-01
eClass 5.0	27-26-07-01
eClass 5.1	27-26-07-04

Similar products

Order No.	Part designation	Version
1774762001	SL-SMT5.08/2/90 1.5SN	PCB plug-in connector, Male connectors, Reflow solder connection, Pitch: 5.08 mm, No. of poles: 2, 90°, Box
1779950000	SL-SMT5.08/2/90 3.2SN	PCB plug-in connector, Male connectors, Reflow solder connection, Pitch: 5.08 mm, No. of poles: 2, 90°, Box
1774772001	SL-SMT5.08/3/90 1.5SN	PCB plug-in connector, Male connectors, Reflow solder connection, Pitch: 5.08 mm, No. of poles: 3, 90°, Box
1779960000	SL-SMT5.08/3/90 3.2SN	PCB plug-in connector, Male connectors, Reflow solder connection, Pitch: 5.08 mm, No. of poles: 3, 90°, Box
1774782001	SL-SMT5.08/4/90 1.5SN	PCB plug-in connector, Male connectors, Reflow solder connection, Pitch: 5.08 mm, No. of poles: 4, 90°, Box
1779970000	SL-SMT5.08/4/90 3.2SN	PCB plug-in connector, Male connectors, Reflow solder connection, Pitch: 5.08 mm, No. of poles: 4, 90°, Box
1779980000	SL-SMT5.08/5/90 3.2SN	PCB plug-in connector, Male connectors, Reflow solder connection, Pitch: 5.08 mm, No. of poles: 5, 90°, Box
1774802001	SL-SMT5.08/6/90 1.5SN	PCB plug-in connector, Male connectors, Reflow solder connection, Pitch: 5.08 mm, No. of poles: 6, 90°, Box
1779990000	SL-SMT5.08/6/90 3.2SN	PCB plug-in connector, Male connectors, Reflow solder connection, Pitch: 5.08 mm, No. of poles: 6, 90°, Box
1774812001	SL-SMT5.08/7/90 1.5SN	PCB plug-in connector, Male connectors, Reflow solder connection, Pitch: 5.08 mm, No. of poles: 7, 90°, Box
1780000000	SL-SMT5.08/7/90 3.2SN	PCB plug-in connector, Male connectors, Reflow solder connection, Pitch: 5.08 mm, No. of poles: 7, 90°, Box
1774822001	SL-SMT5.08/8/90 1.5SN	PCB plug-in connector, Male connectors, Reflow solder connection, Pitch: 5.08 mm, No. of poles: 8, 90°, Box

1780010000	SL-SMT5.08/8/90 3.2SN	PCB plug-in connector, Male connectors, Reflow solder connection, Pitch: 5.08 mm, No. of poles: 8, 90°, Box
1774832001	SL-SMT5.08/9/90 1.5SN	PCB plug-in connector, Male connectors, Reflow solder connection, Pitch: 5.08 mm, No. of poles: 9, 90°, Box
1780020000	SL-SMT5.08/9/90 3.2SN	PCB plug-in connector, Male connectors, Reflow solder connection, Pitch: 5.08 mm, No. of poles: 9, 90°, Box
1774842001	SL-SMT5.08/10/90 1.5SN	PCB plug-in connector, Male connectors, Reflow solder connection, Pitch: 5.08 mm, No. of poles: 10, 90°, Box
1780030000	SL-SMT5.08/10/90 3.2SN	PCB plug-in connector, Male connectors, Reflow solder connection, Pitch: 5.08 mm, No. of poles: 10, 90°, Box
1774852001	SL-SMT5.08/11/90 1.5SN	PCB plug-in connector, Male connectors, Reflow solder connection, Pitch: 5.08 mm, No. of poles: 11, 90°, Box
1780040000	SL-SMT5.08/11/90 3.2SN	PCB plug-in connector, Male connectors, Reflow solder connection, Pitch: 5.08 mm, No. of poles: 11, 90°, Box
1774862001	SL-SMT5.08/12/90 1.5SN	PCB plug-in connector, Male connectors, Reflow solder connection, Pitch: 5.08 mm, No. of poles: 12, 90°, Box
1780050000	SL-SMT5.08/12/90 3.2SN	PCB plug-in connector, Male connectors, Reflow solder connection, Pitch: 5.08 mm, No. of poles: 12, 90°, Box
1774872001	SL-SMT5.08/13/90 1.5SN	PCB plug-in connector, Male connectors, Reflow solder connection, Pitch: 5.08 mm, No. of poles: 13, 90°, Box
1780060000	SL-SMT5.08/13/90 3.2SN	PCB plug-in connector, Male connectors, Reflow solder connection, Pitch: 5.08 mm, No. of poles: 13, 90°, Box
1774882001	SL-SMT5.08/14/90 1.5SN	PCB plug-in connector, Male connectors, Reflow solder connection, Pitch: 5.08 mm, No. of poles: 14, 90°, Box
1780070000	SL-SMT5.08/14/90 3.2SN	PCB plug-in connector, Male connectors, Reflow solder connection, Pitch: 5.08 mm, No. of poles: 14, 90°, Box
1774892001	SL-SMT5.08/15/90 1.5SN	PCB plug-in connector, Male connectors, Reflow solder connection, Pitch: 5.08 mm, No. of poles: 15, 90°, Box
1780080000	SL-SMT5.08/15/90 3.2SN	PCB plug-in connector, Male connectors, Reflow solder connection, Pitch: 5.08 mm, No. of poles: 15, 90°, Box
1774902001	SL-SMT5.08/16/90 1.5SN	PCB plug-in connector, Male connectors, Reflow solder connection, Pitch: 5.08 mm, No. of poles: 16, 90°, Box
1780090000	SL-SMT5.08/16/90 3.2SN	PCB plug-in connector, Male connectors, Reflow solder connection, Pitch: 5.08 mm, No. of poles: 16, 90°, Box
1774912001	SL-SMT5.08/17/90 1.5SN	PCB plug-in connector, Male connectors, Reflow solder connection, Pitch: 5.08 mm, No. of poles: 17, 90°, Box
1780100000	SL-SMT5.08/17/90 3.2SN	PCB plug-in connector, Male connectors, Reflow solder connection, Pitch: 5.08 mm, No. of poles: 17, 90°, Box
1774922001	SL-SMT5.08/18/90 1.5SN	PCB plug-in connector, Male connectors, Reflow solder connection, Pitch: 5.08 mm, No. of poles: 18, 90°, Box
1780110000	SL-SMT5.08/18/90 3.2SN	PCB plug-in connector, Male connectors, Reflow solder connection, Pitch: 5.08 mm, No. of poles: 18, 90°, Box
1774932001	SL-SMT5.08/19/90 1.5SN	PCB plug-in connector, Male connectors, Reflow solder connection, Pitch: 5.08 mm, No. of poles: 19, 90°, Box
1780120000	SL-SMT5.08/19/90 3.2SN	PCB plug-in connector, Male connectors, Reflow solder connection, Pitch: 5.08 mm, No. of poles: 19, 90°, Box
1774942001	SL-SMT5.08/20/90 1.5SN	PCB plug-in connector, Male connectors, Reflow solder connection, Pitch: 5.08 mm, No. of poles: 20, 90°, Box
1780130000	SL-SMT5.08/20/90 3.2SN	PCB plug-in connector, Male connectors, Reflow solder connection, Pitch: 5.08 mm, No. of poles: 20, 90°, Box
1774952001	SL-SMT5.08/21/90 1.5SN	PCB plug-in connector, Male connectors, Reflow solder connection, Pitch: 5.08 mm, No. of poles: 21, 90°, Box

1780140000	SL-SMT5.08/21/90 3.2SN	PCB plug-in connector, Male connectors, Reflow solder connection, Pitch: 5.08 mm, No. of poles: 21, 90°, Box
1774962001	SL-SMT5.08/22/90 1.5SN	PCB plug-in connector, Male connectors, Reflow solder connection, Pitch: 5.08 mm, No. of poles: 22, 90°, Box
1780150000	SL-SMT5.08/22/90 3.2SN	PCB plug-in connector, Male connectors, Reflow solder connection, Pitch: 5.08 mm, No. of poles: 22, 90°, Box
1774972001	SL-SMT5.08/23/90 1.5SN	PCB plug-in connector, Male connectors, Reflow solder connection, Pitch: 5.08 mm, No. of poles: 23, 90°, Box
1780160000	SL-SMT5.08/23/90 3.2SN	PCB plug-in connector, Male connectors, Reflow solder connection, Pitch: 5.08 mm, No. of poles: 23, 90°, Box
1774982001	SL-SMT5.08/24/90 1.5SN	PCB plug-in connector, Male connectors, Reflow solder connection, Pitch: 5.08 mm, No. of poles: 24, 90°, Box
1780170000	SL-SMT5.08/24/90 3.2SN	PCB plug-in connector, Male connectors, Reflow solder connection, Pitch: 5.08 mm, No. of poles: 24, 90°, Box