



Chipsmall Limited consists of a professional team with an average of over 10 year of expertise in the distribution of electronic components. Based in Hongkong, we have already established firm and mutual-benefit business relationships with customers from,Europe,America and south Asia,supplying obsolete and hard-to-find components to meet their specific needs.

With the principle of “Quality Parts,Customers Priority,Honest Operation,and Considerate Service”,our business mainly focus on the distribution of electronic components. Line cards we deal with include Microchip,ALPS,ROHM,Xilinx,Pulse,ON,Everlight and Freescale. Main products comprise IC,Modules,Potentiometer,IC Socket,Relay,Connector.Our parts cover such applications as commercial,industrial, and automotives areas.

We are looking forward to setting up business relationship with you and hope to provide you with the best service and solution. Let us make a better world for our industry!



Contact us

Tel: +86-755-8981 8866 Fax: +86-755-8427 6832

Email & Skype: info@chipsmall.com Web: www.chipsmall.com

Address: A1208, Overseas Decoration Building, #122 Zhenhua RD., Futian, Shenzhen, China



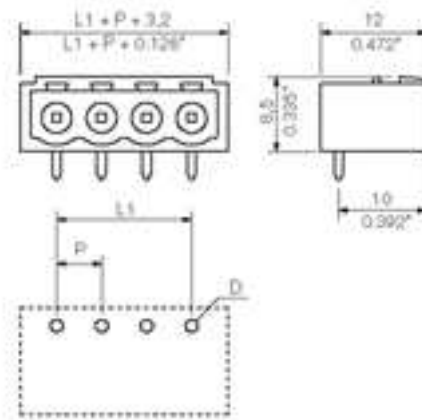

General ordering data

Order No.	1775012001
Part designation	SL-SMT5.08/3/90G 1.5SN
Version	PCB plug-in connector, Male connectors, Reflow solder connection, Pitch: 5.08 mm, No. of poles: 3, 90°, Box
EAN	4032248156030
Qty.	100 pc(s).

System parameters

Fitted to PCB	Reflow solder connection
Outgoing elbow	90°
Pitch	5.08 mm
Pitch in inch	0.2 inch
No. of poles	3
Solder pin length	1.5 mm
Can be coded	Yes
No. of solder pins per pole	1
L1 in mm	10.16 mm
L1 in inch	0.4 inch

Material data

Insulating material	LCP GF
Colour	black

Material data

colour chart	Similar to RAL 9011
Insulating material group	IIIa
Flammability class UL 94	V-0
Contact base material	CuSn
Contact surface	tinned
Constant operating temp., min.	-25 °C
Constant operating temp., max.	100
Storage temperature, min.	-25 °C
Storage temperature, max.	55 °C
Max. relative humidity during storage	80 %

DIN IEC rating data

Rated current, min. No. pins (Tu=20°C)	19 A
Rated current, max. No. pins (Tu=20°C)	15 A
Rated current, min. No. pins (Tu=40°C)	16 A
Rated current, max. No. pins (Tu=40°C)	13 A
Rated voltage for overvoltage class/pollution severity III/3	250 V
Rated impulse withstand voltage for overvoltage class/pollution severity III/3	4 kV
Rated voltage for overvoltage class/pollution severity III/2	320 V
Rated impulse withstand voltage for overvoltage class/pollution severity III/2	4 kV
Rated voltage for overvoltage class/pollution severity II/2	400 V
Rated impulse withstand voltage for overvoltage class/pollution severity II/2	4 kV

CSA rating data

Rated voltage (Use group D)	300 V
Rated current (Use group D)	10 A

UL 1059 rating data

Rated voltage (Use group D)	300 V
Rated current (Use group D)	10 A

Approvals

Approvals institutes



Classifications

ETIM 2.0	NK
ETIM 3.0	EC001284
eClass 4.1	27-26-07-01
eClass 5.0	27-26-07-01
eClass 5.1	27-26-07-04

Similar products

Order No.	Part designation	Version
1775002001	SL-SMT5.08/2/90G 1.5SN	PCB plug-in connector, Male connectors, Reflow solder connection, Pitch: 5.08 mm, No. of poles: 2, 90°, Box
1780180000	SL-SMT5.08/2/90G 3.2SN	PCB plug-in connector, Male connectors, Reflow solder connection, Pitch: 5.08 mm, No. of poles: 2, 90°, Box
1780190000	SL-SMT5.08/03/90G 3.2SN	PCB plug-in connector, Male connectors, Reflow solder connection, Pitch: 5.08 mm, No. of poles: 3, 90°, Box
1775022001	SL-SMT5.08/4/90G 1.5SN	PCB plug-in connector, Male connectors, Reflow solder connection, Pitch: 5.08 mm, No. of poles: 4, 90°, Box
1780200000	SL-SMT5.08/04/90G 3.2SN	PCB plug-in connector, Male connectors, Reflow solder connection, Pitch: 5.08 mm, No. of poles: 4, 90°, Box
1775032001	SL-SMT5.08/5/90G 1.5SN	PCB plug-in connector, Male connectors, Reflow solder connection, Pitch: 5.08 mm, No. of poles: 5, 90°, Box
1780210000	SL-SMT5.08/05/90G 3.2SN	PCB plug-in connector, Male connectors, Reflow solder connection, Pitch: 5.08 mm, No. of poles: 5, 90°, Box
1775042001	SL-SMT5.08/6/90G 1.5SN	PCB plug-in connector, Male connectors, Reflow solder connection, Pitch: 5.08 mm, No. of poles: 6, 90°, Box
1780220000	SL-SMT5.08/06/90G 3.2SN	PCB plug-in connector, Male connectors, Reflow solder connection, Pitch: 5.08 mm, No. of poles: 6, 90°, Box
1775052001	SL-SMT5.08/7/90G 1.5SN	PCB plug-in connector, Male connectors, Reflow solder connection, Pitch: 5.08 mm, No. of poles: 7, 90°, Box
1780230000	SL-SMT5.08/07/90G 3.2SN	PCB plug-in connector, Male connectors, Reflow solder connection, Pitch: 5.08 mm, No. of poles: 7, 90°, Box
1775062001	SL-SMT5.08/8/90G 1.5SN	PCB plug-in connector, Male connectors, Reflow solder connection, Pitch: 5.08 mm, No. of poles: 8, 90°, Box

1780240000	SL-SMT5.08/08/90G 3.2SN	PCB plug-in connector, Male connectors, Reflow solder connection, Pitch: 5.08 mm, No. of poles: 8, 90°, Box
1775072001	SL-SMT5.08/9/90G 1.5SN	PCB plug-in connector, Male connectors, Reflow solder connection, Pitch: 5.08 mm, No. of poles: 9, 90°, Box
1780250000	SL-SMT5.08/09/90G 3.2SN	PCB plug-in connector, Male connectors, Reflow solder connection, Pitch: 5.08 mm, No. of poles: 9, 90°, Box
1775082001	SL-SMT5.08/10/90G 1.5SN	PCB plug-in connector, Male connectors, Reflow solder connection, Pitch: 5.08 mm, No. of poles: 10, 90°, Box
1780260000	SL-SMT5.08/10/90G 3.2SN	PCB plug-in connector, Male connectors, Reflow solder connection, Pitch: 5.08 mm, No. of poles: 10, 90°, Box
1775092001	SL-SMT5.08/11/90G 1.5SN	PCB plug-in connector, Male connectors, Reflow solder connection, Pitch: 5.08 mm, No. of poles: 11, 90°, Box
1780270000	SL-SMT5.08/11/90G 3.2SN	PCB plug-in connector, Male connectors, Reflow solder connection, Pitch: 5.08 mm, No. of poles: 11, 90°, Box
1775102001	SL-SMT5.08/12/90G 1.5SN	PCB plug-in connector, Male connectors, Reflow solder connection, Pitch: 5.08 mm, No. of poles: 12, 90°, Box
1780280000	SL-SMT5.08/12/90G 3.2SN	PCB plug-in connector, Male connectors, Reflow solder connection, Pitch: 5.08 mm, No. of poles: 12, 90°, Box
1775112001	SL-SMT5.08/13/90G 1.5SN	PCB plug-in connector, Male connectors, Reflow solder connection, Pitch: 5.08 mm, No. of poles: 13, 90°, Box
1780290000	SL-SMT5.08/13/90G 3.2SN	PCB plug-in connector, Male connectors, Reflow solder connection, Pitch: 5.08 mm, No. of poles: 13, 90°, Box
1775122001	SL-SMT5.08/14/90G 1.5SN	PCB plug-in connector, Male connectors, Reflow solder connection, Pitch: 5.08 mm, No. of poles: 14, 90°, Box
1780300000	SL-SMT5.08/14/90G 3.2SN	PCB plug-in connector, Male connectors, Reflow solder connection, Pitch: 5.08 mm, No. of poles: 14, 90°, Box
1775132001	SL-SMT5.08/15/90G 1.5SN	PCB plug-in connector, Male connectors, Reflow solder connection, Pitch: 5.08 mm, No. of poles: 15, 90°, Box
1780310000	SL-SMT5.08/15/90G 3.2SN	PCB plug-in connector, Male connectors, Reflow solder connection, Pitch: 5.08 mm, No. of poles: 15, 90°, Box
1775142001	SL-SMT5.08/16/90G 1.5SN	PCB plug-in connector, Male connectors, Reflow solder connection, Pitch: 5.08 mm, No. of poles: 16, 90°, Box
1780320000	SL-SMT5.08/16/90G 3.2SN	PCB plug-in connector, Male connectors, Reflow solder connection, Pitch: 5.08 mm, No. of poles: 16, 90°, Box
1775152001	SL-SMT5.08/17/90G 1.5SN	PCB plug-in connector, Male connectors, Reflow solder connection, Pitch: 5.08 mm, No. of poles: 17, 90°, Box
1780330000	SL-SMT5.08/17/90G 3.2SN	PCB plug-in connector, Male connectors, Reflow solder connection, Pitch: 5.08 mm, No. of poles: 17, 90°, Box
1775162001	SL-SMT5.08/18/90G 1.5SN	PCB plug-in connector, Male connectors, Reflow solder connection, Pitch: 5.08 mm, No. of poles: 18, 90°, Box
1780340000	SL-SMT5.08/18/90G 3.2SN	PCB plug-in connector, Male connectors, Reflow solder connection, Pitch: 5.08 mm, No. of poles: 18, 90°, Box
1775172001	SL-SMT5.08/19/90G 1.5SN	PCB plug-in connector, Male connectors, Reflow solder connection, Pitch: 5.08 mm, No. of poles: 19, 90°, Box
1780350000	SL-SMT5.08/19/90G 3.2SN	PCB plug-in connector, Male connectors, Reflow solder connection, Pitch: 5.08 mm, No. of poles: 19, 90°, Box
1775182001	SL-SMT5.08/20/90G 1.5SN	PCB plug-in connector, Male connectors, Reflow solder connection, Pitch: 5.08 mm, No. of poles: 20, 90°, Box
1780360000	SL-SMT5.08/20/90G 3.2SN	PCB plug-in connector, Male connectors, Reflow solder connection, Pitch: 5.08 mm, No. of poles: 20, 90°, Box
1775192001	SL-SMT5.08/21/90G 1.5SN	PCB plug-in connector, Male connectors, Reflow solder connection, Pitch: 5.08 mm, No. of poles: 21, 90°, Box

1780370000	SL-SMT5.08/21/90G 3.2SN	PCB plug-in connector, Male connectors, Reflow solder connection, Pitch: 5.08 mm, No. of poles: 21, 90°, Box
1775202001	SL-SMT5.08/22/90G 1.5SN	PCB plug-in connector, Male connectors, Reflow solder connection, Pitch: 5.08 mm, No. of poles: 22, 90°, Box
1780380000	SL-SMT5.08/22/90G 3.2SN	PCB plug-in connector, Male connectors, Reflow solder connection, Pitch: 5.08 mm, No. of poles: 22, 90°, Box
1775212001	SL-SMT5.08/23/90G 1.5SN	PCB plug-in connector, Male connectors, Reflow solder connection, Pitch: 5.08 mm, No. of poles: 23, 90°, Box
1780390000	SL-SMT5.08/23/90G 3.2SN	PCB plug-in connector, Male connectors, Reflow solder connection, Pitch: 5.08 mm, No. of poles: 23, 90°, Box
1775222001	SL-SMT5.08/24/90G 1.5SN	PCB plug-in connector, Male connectors, Reflow solder connection, Pitch: 5.08 mm, No. of poles: 24, 90°, Box
1780400000	SL-SMT5.08/24/90G 3.2SN	PCB plug-in connector, Male connectors, Reflow solder connection, Pitch: 5.08 mm, No. of poles: 24, 90°, Box