



Chipsmall Limited consists of a professional team with an average of over 10 year of expertise in the distribution of electronic components. Based in Hongkong, we have already established firm and mutual-benefit business relationships with customers from,Europe,America and south Asia,supplying obsolete and hard-to-find components to meet their specific needs.

With the principle of “Quality Parts,Customers Priority,Honest Operation,and Considerate Service”,our business mainly focus on the distribution of electronic components. Line cards we deal with include Microchip,ALPS,ROHM,Xilinx,Pulse,ON,Everlight and Freescale. Main products comprise IC,Modules,Potentiometer,IC Socket,Relay,Connector.Our parts cover such applications as commercial,industrial, and automotives areas.

We are looking forward to setting up business relationship with you and hope to provide you with the best service and solution. Let us make a better world for our industry!



Contact us

Tel: +86-755-8981 8866 Fax: +86-755-8427 6832

Email & Skype: info@chipsmall.com Web: www.chipsmall.com

Address: A1208, Overseas Decoration Building, #122 Zhenhua RD., Futian, Shenzhen, China



UMCC – Ultraminiature Coax Connector & Cable Assembly Series

DESCRIPTION

Tyco Electronics introduces the Ultraminiature Coax Connector and Cable Assembly series products. The UMCC series is an ultra low profile coax interconnect solution that meets the ever growing demand for miniaturization in next generation wireless applications. UMCC cable assemblies and connectors are available as double-ended jumpers and inter-series assemblies, and PCB jack receptacles for board mount applications.

Tyco Electronics specializes in solving tough problems with cable assemblies designed and manufactured to meet the most demanding requirements. Tyco Electronics can engineer custom UMCC solutions to meet special requirements. By making Tyco Electronics your partner in cable assembly design, you reduce risk and gain assurance that you will receive your assembly on time, to specification and within budget.

APPLICATIONS

- Wireless LAN, Mini PCI
- Mobile Antenna/GPS/Radio Systems
- PDA / PCS / Cellular Handset applications
- Wireless Communications systems (LAN, GSM, PCS, WCDMA, UMTS)
- Remote measuring equipment

KEY FEATURES

- Ultra low profile (2.0mm Type II or 2.5mm Type III maximum mated height)
- Easy snap on/off mating
- Small footprint on PCB (3mm x 3mm)
- Excellent performance to 6 GHz
- Surface mount and reflow solderable
- 360 degree mated rotation
- Available on 0.81mm, 1.13mm, and 1.37mm dia single shield, and 1.32mm dia double shield cable
- Compatible with Hirose U.FL/U.FL(v) Series connectors

For More Information

Technical Support

Internet:

<http://tycoelectronics.com/products/rfcoax>

Email:

product.info@tycoelectronics.com

US Product Manager Cable Assemblies — David Stonfer

Phone: 717-986-5950

Email: david.stonfer@tycoelectronics.com

Global Product Manager Connectors — Claude de Lorraine

Phone: 717-986-5793

Email: cdeLorraine@tycoelectronics.com

Europe Product Manager — Rob Smeets

Phone: +31-736246327

Email: r.smeets@tycoelectronics.com

USA: 1-800-522-6752

Canada: 1-905-470-4425

Mexico: 01-800-733-8926

C. America: 52-55-1106-0803

South America: 55-112103-6000

Hong Kong: 852-2735-1628

Japan: 81-44-844-8013

UK: 31 73 6246 431

SPECIFICATIONS

ELECTRICAL

Characteristic Impedance:	50 Ohms
Frequency Range:	DC to 6 GHz
VSWR (mated pair):	1.30 max DC to 3 GHz 1.5 max 3 to 6 GHz (typical)
Insertion Loss (connectors only):	0.24 dB max DC to 6 GHz
Rated voltage:	60 VAC (rms) – standard recept
Dielectric Withstanding Voltage:	200 VAC, 50 Hz for 1 min (at sea level)
Insulation Resistance:	500 Megohms min
Contact Resistance (connectors only):	20 milliohms max (Center) 10 milliohms max (Outer, Plug) 10 milliohms max (Outer, Receptacle)

MECHANICAL / ENVIRONMENTAL

Durability:	30 cycles – standard recept
Disengagement Force:	2N min perpendicular 4N min orthogonal
Center Contact Retention force:	0.15N min
Tape/Reel Packaging (receptacle):	12mm carrier per EIA-481
Operating Temperature:	- 40°C to + 90°C

MATERIAL

Part Description	Material	Finish
Shell	Phosphor Bronze	Gold or Silver Plating
Male Center Contact	Brass or Phos Bronze	Gold Plating
Female Center Contact	Brass or Phos Bronze	Gold Plating
Insulator (Plug)	PBT (15% G.F.)	Black, UL94V-0
Insulator (Receptacle)	LCP	Beige or Black, UL94V-0

SPECIFICATIONS

CABLE INFORMATION

	0.81 mm Diameter	1.13 mm Diameter	1.32mm Diameter	1.37mm Diameter
MATERIALS:				
Center Conductor	Silver Plated Copper	Silver Plated Copper	Silver Plated Copper	Silver Plated Copper
Size	Stranded 7/0.05 mm	Stranded 7/0.08 mm	Stranded 7/0.08 mm	Stranded 7/0.10 mm
Dielectric	FEP or PFA	FEP	FEP	FEP
Size	0.40 mm OD	0.62 mm OD	0.66 mm OD	0.83 mm OD
Shield	Silver Plated Copper Braid	Silver Plated Copper Braid	Double SPL Braid	Silver Plated Copper Braid
Coverage	> 90%	> 90%	> 90%	> 90%
Jacket	FEP or PFA	FEP	> 90%	> 90%
Size	0.81 mm OD	1.13 mm OD	1.32 mm OD	1.37 mm OD

MECHANICAL:

Minimum Bend Radius	5 mm Single Bend 30 mm Continuous Flexing	5 mm Single Bend 30 mm Continuous Flexing	5 mm Single Bend 30 mm Continuous Flexing	5 mm Single Bend 30 mm Continuous Flexing
---------------------	--	--	--	--

ELECTRICAL:

Impedance (Ohms)	50±2	50±2	50±2	50±2
Velocity of Propagation	70%	70%	70%	70%
CC Resistance (Ohms/M)	1.450	0.750	0.560	0.354
Voltage Rating	60 VAC	60 VAC	60 VAC	60 VAC
Attenuation	See Chart	See Chart	See Chart	See Chart

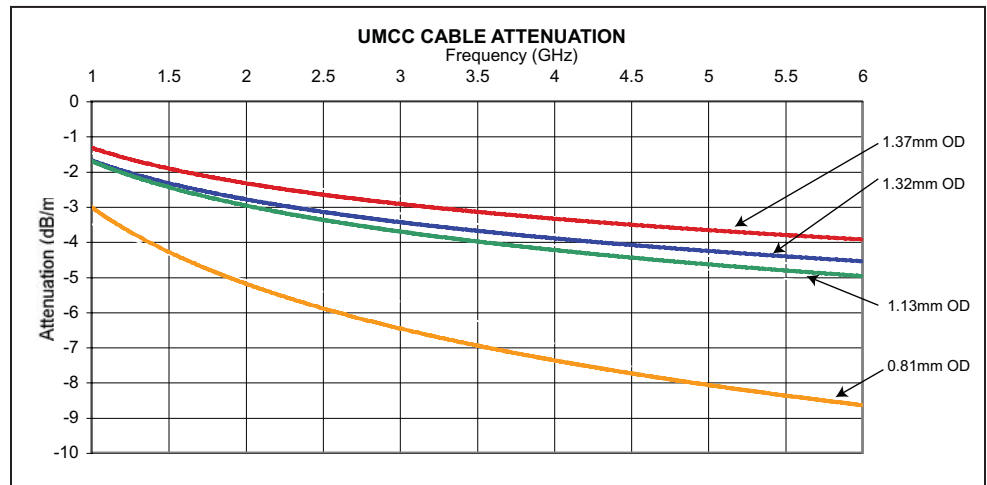
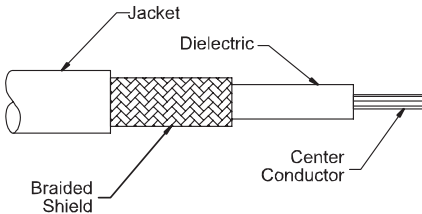

Dimensions are millimeters [inches] unless otherwise specified.

Standard Double Ended Cable Assemblies

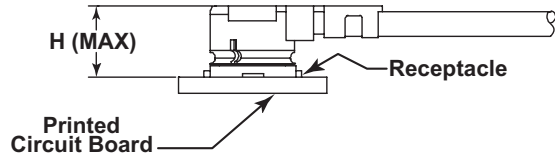

Part Number	Cable Dia	Length L	UMCC Cable Connector Type	Mated Height (H)
2015698-4	0.81mm	50mm	II	2.0mm
2015698-2	0.81mm	100mm	II	2.0mm
2015698-3	0.81mm	200mm	II	2.0mm
2015699-3	0.81mm	50mm	III	2.5mm
2015699-1	0.81mm	100mm	III	2.5mm
2015699-2	0.81mm	200mm	III	2.5mm
2015487-6	1.13mm	50mm	III	2.5mm
2015487-4	1.13mm	100mm	III	2.5mm
2015487-5	1.13mm	200mm	III	2.5mm
2015700-3	1.32mm	50mm	III	2.5mm
2015700-1	1.32mm	100mm	III	2.5mm
2015700-2	1.32mm	200mm	III	2.5mm
2015357-2	1.37mm	50mm	III	2.5mm
2015357-3	1.37mm	100mm	III	2.5mm
2015357-4	1.37mm	200mm	III	2.5mm

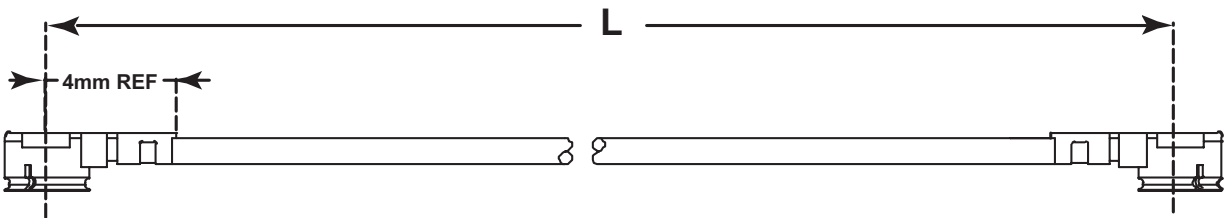

Total Length (mm)	Standard Tolerance (mm)
25 < L < 200	+/- 2
200 < L < 700	+/- 3
700 < L < 900	+/- 4
900 < L	+/- 5

Note: Shortest length L is 25mm

Custom cable assembly lengths available. Contact Tyco Electronics with specific requirements.

Interseries Cable Assemblies



Part Number	Description	Cable Dia	UMCC Conn Type	Mated Height (H)
2032439-1	UMCC to STD SMA Plug	1.37mm	III	2.5mm
2032440-1	UMCC to STD SMA BHD Jack	1.37mm	III	2.5mm
2032445-1	UMCC to R/P SMA BHD Jack	1.13mm	III	2.5mm
2032446-1	UMCC to R/P TNC BHD Jack	1.13mm	III	2.5mm
2032407-2	UMCC to STD TNC BHD Jack	1.13mm	III	2.5mm
2032441-1	UMCC to MCX R/A Plug	0.81mm	II	2.0mm
2032442-1	UMCC to MCX R/A Plug	1.37mm	III	2.5mm
2032443-1	UMCC to MMCX R/A Plug	0.81mm	II	2.0mm
2032444-1	UMCC TO MMCX R/A Plug	1.37mm	III	2.5mm

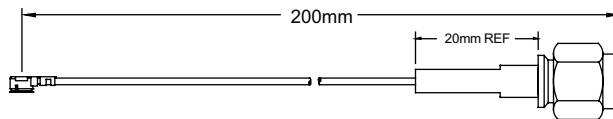

UMCC to SMA Plug

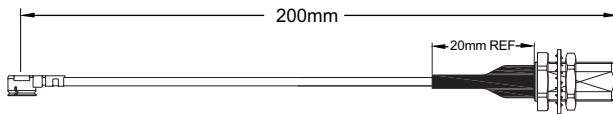

UMCC to SMA Bulkhead Jack

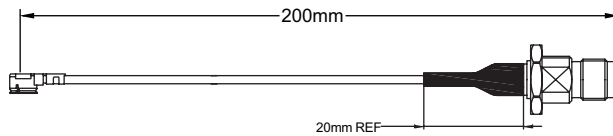

UMCC to TNC

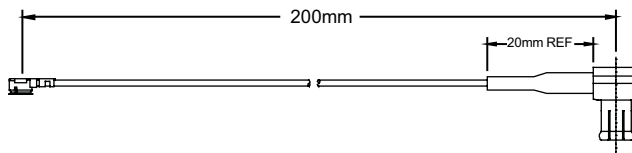

UMCC to MCX R/A Plug

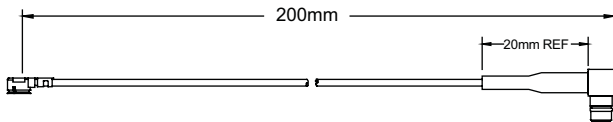

UMCC to MMCX R/A Plug

Standard length is 200mm.
Custom cable assembly lengths and connector configurations are available.
Contact Tyco Electronics with specific requirements.

Adapters

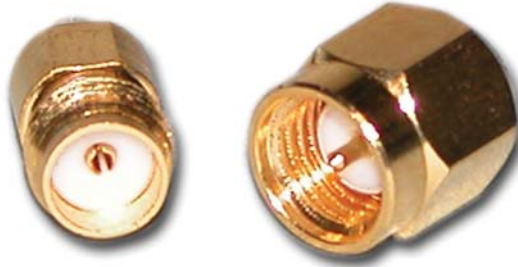

Part Number	Description	UMCC Conn Type
1775230-1	UMCC Plug to SMA Jack	II/III
1775227-1	UMCC Jack Receptacle to SMA Plug	II/III

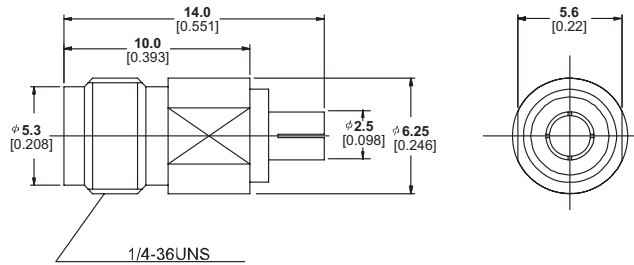

Part Number 1775230

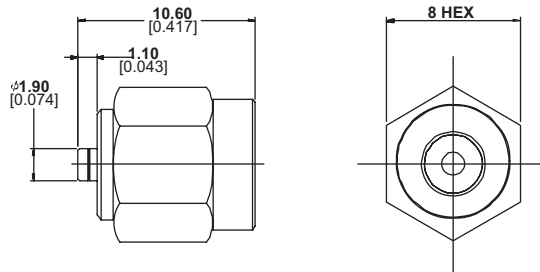

Part Number 1775227

Dimensions are millimeters [inches] unless otherwise specified

PCB Receptacles

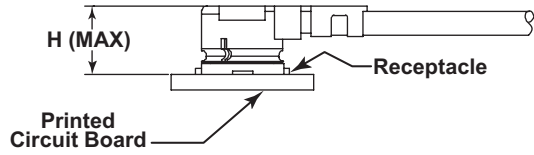

Part Number	Description	Mates with UMCC Cable Conn Type	Mated Height (H)	Packaging
1566230-1	UMCC PCB Receptacle	II/III	2.0mm/2.5mm	Tape (2500 pieces/reel)
1566230-2	UMCC PCB Receptacle	II/III	2.0mm/2.5mm	Bulk (500 pieces/bag)

UMCC PCB Receptacle

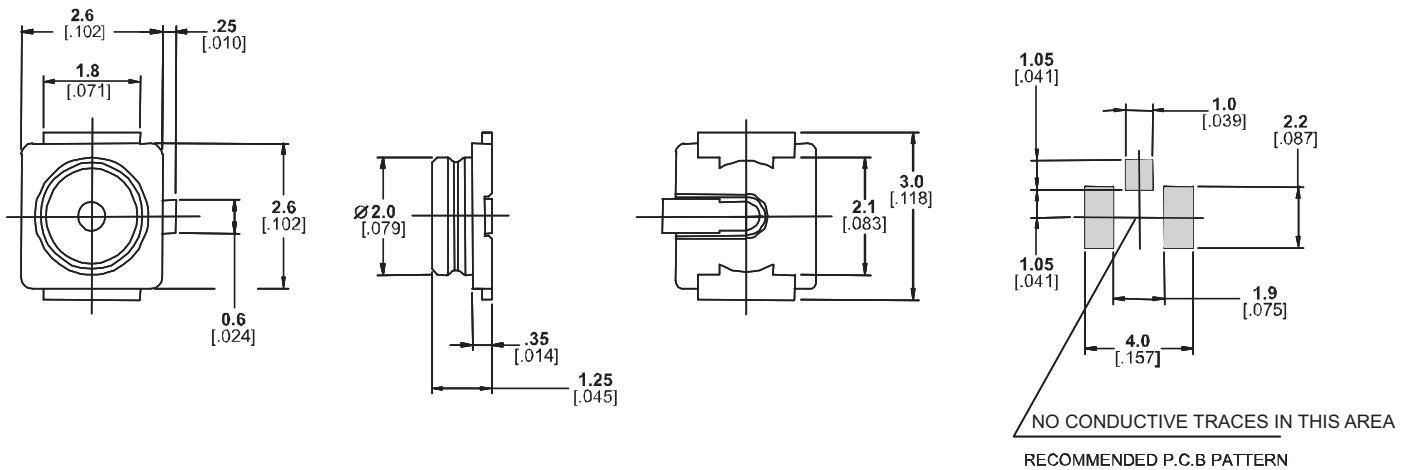

Dimensions are millimeters [inches] unless otherwise specified

Application Notes

Soldering Profile - SMT Receptacle

Recommended Temperature Profile (Reference)

- 1) The preferred technique for mounting the SMT Receptacle package is to reflow solder the device onto a PCB (Printed Circuit Board).
- 2) The maximum temperature for the lead of PCB surface does not exceed 240 .
- 3) The right reflow soldering profile is for reference and will modify under individual different conditions.

Hand Soldering (Reference only)

- 1) Soldering iron: The maximum temperature 240 .
- 2) Soldering period: within 5 seconds.

RECOMMENDED TEMPERATURE PROFILE (REFERENCE)

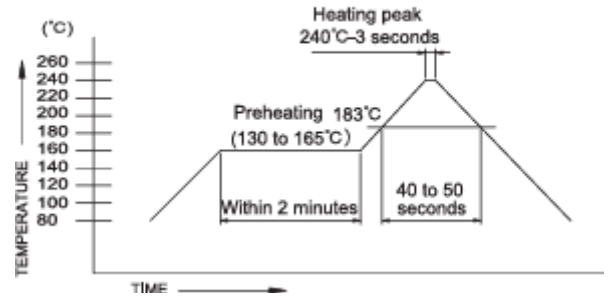

Tape and Reel Packaging Specifications

Standard Receptacles

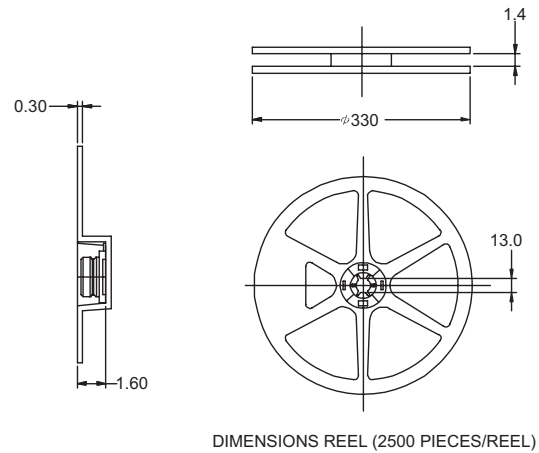
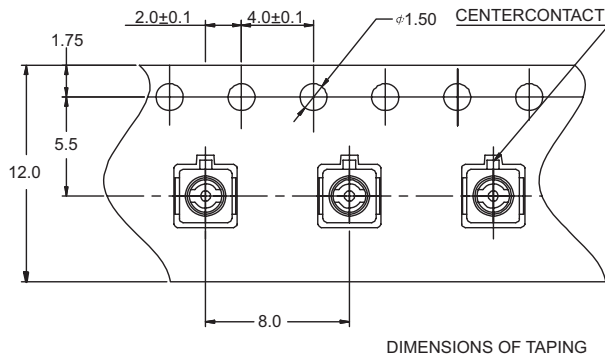

Application Notes

Extraction Tool

Part Number: 1775231-1

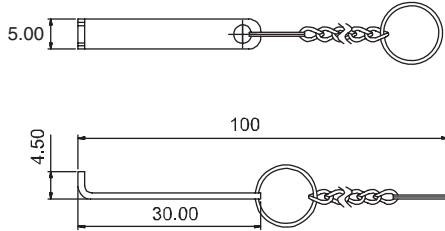

Mating/Unmaking — Cable Plugs

- 1) To mate the connectors, insert the cable plug into the SMT receptacle, making sure the cable plug is as vertical as possible and the mating axis of both connectors are aligned. Do not insert on an extreme angle.
- 2) To unmate the connectors, insert the end portion of the extraction tool under the SMT receptacle connector flanges and pull off vertically in the direction of the mating axis.

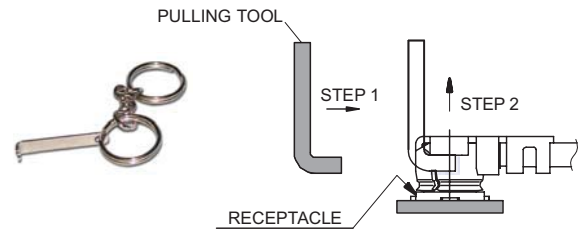

Permissible Load

Do not apply excessive load to the cable after the connectors are mated. Please refer to the permissible loads indicated in the figure to the right.

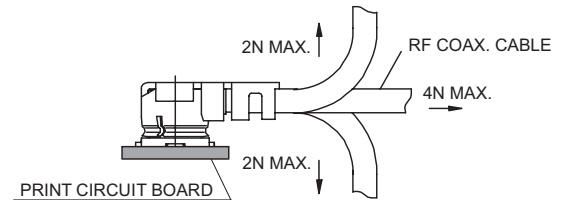

Disclaimer

While Tyco Electronics Corporation and its affiliates referenced herein (“Tyco Electronics”) have made every reasonable effort to ensure the accuracy of the information in this catalog, Tyco Electronics does not guarantee that it is error free, nor does Tyco Electronics make any other representation, warranty or guarantee that the information is accurate, correct reliable or current.

Tyco Electronics reserves the right to make any adjustments to the information contained herein at any time without notice.

Tyco Electronics expressly disclaims all implied warranties regarding the information contained herein, including, but not limited to, any implied warranties of merchantability or fitness for a particular purpose. Tyco Electronics' only obligations are those in the Tyco Electronics Standard Terms and Conditions of Sale, and in no case will Tyco Electronics be responsible for any incidental, indirect, or consequential damages arising from the sale, resale, or misuse of its products. Users should independently evaluate the suitability of, and test each product for, their application

Copyright 2008 by Tyco Electronics Corporation. All Rights Reserved.

TE LOGO and TYCO ELECTRONICS are trademarks.

HIROSE is a trademark of Hirose Electric U.S.A. Hirose Electric U.S.A. is not affiliated with the UMCC product.

Other products, logos, and Company names mentioned herein maybe trademarks of their respective owners.

1-1773441-5_08/08_CCCE_PDF