



Chipsmall Limited consists of a professional team with an average of over 10 year of expertise in the distribution of electronic components. Based in Hongkong, we have already established firm and mutual-benefit business relationships with customers from,Europe,America and south Asia,supplying obsolete and hard-to-find components to meet their specific needs.

With the principle of "Quality Parts,Customers Priority,Honest Operation,and Considerate Service",our business mainly focus on the distribution of electronic components. Line cards we deal with include Microchip,ALPS,ROHM,Xilinx,Pulse,ON,Everlight and Freescale. Main products comprise IC,Modules,Potentiometer,IC Socket,Relay,Connector.Our parts cover such applications as commercial,industrial, and automotives areas.

We are looking forward to setting up business relationship with you and hope to provide you with the best service and solution. Let us make a better world for our industry!



## Contact us

Tel: +86-755-8981 8866 Fax: +86-755-8427 6832

Email & Skype: info@chipsmall.com Web: www.chipsmall.com

Address: A1208, Overseas Decoration Building, #122 Zhenhua RD., Futian, Shenzhen, China



# Type 1776 Precision Decade Resistor Voltage Dividers

## Input Voltage Dividers for Digital Multimeters and Range-Switching Instruments Introducing New Smaller Models at Lower Cost

The exceptional performance of this extensive family of Type 1776 Precision Decade Resistor Voltage Dividers has been achieved through the special combination of advantages provided by Caddock's Tetrinox® resistance films. This advanced film resistor technology provides the performance characteristics required by the precision input signal circuits of both bench-type and laboratory digital instruments.

In addition to requiring less board space, these compact precision resistor networks deliver higher performance than selected discrete resistor sets and thin-film networks.

There are now 39 standard models in the expanded family of Type 1776 precision resistor networks that include:

- 3, 4, and 5 - decade voltage dividers with ratios from 10:1 to 10,000:1.
- 1,200 volts continuous ratings and overvoltage to 2,000 volts.
- Many combinations of Ratio and Absolute Tolerance, and Ratio and Absolute Temperature Coefficient.

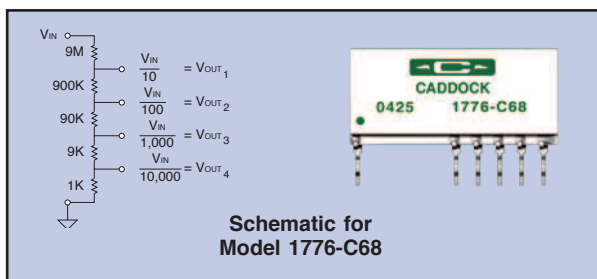

For complete information on quantity price and delivery, contact our Sales Office.

Model No.	Resistance Values					Fig.	Voltage Rating (7)	Absolute Tolerance %	Ratio Tolerance % (1)	Abs. TC ppm/°C	Ratio TC ppm/°C (2)	TC Temp. Range (2)	Voltage Coef. of Ratio ppm/volt (3)	Ratio Stability % Change in Ratio		
	R1	R2	R3	R4	R5									Load Life (4)	Shelf Life (5)	Over-Voltage (6)
1776-C67	9 Meg	900 K	90 K	9 K	900	10	1200	0.1	0.1	30	10	Range 1	0.04	0.01	0.003	0.005
1776-C671	9 Meg	900 K	90 K	9 K	900	10	1200	0.1	0.05	30	10	Range 1	0.04	0.01	0.003	0.005
1776-C6715	9 Meg	900 K	90 K	9 K	900	10	1200	0.1	0.05	30	5	Range 1	0.04	0.01	0.003	0.005
1776-C68	9 Meg	900 K	90 K	9 K	1 K	10	1200	0.1	0.1	30	10	Range 1	0.04	0.01	0.003	0.005
1776-C681	9 Meg	900 K	90 K	9 K	1 K	10	1200	0.1	0.05	30	10	Range 1	0.04	0.01	0.003	0.005
1776-C6815	9 Meg	900 K	90 K	9 K	1 K	10	1200	0.1	0.05	30	5	Range 1	0.04	0.01	0.003	0.005
1776-C48	10 Meg	1.1111M	101.01K	10.01K	1.0001K	11	1200	0.1	0.1	30	10	Range 1	0.03	0.01	0.003	0.005
1776-C481	10 Meg	1.1111M	101.01K	10.01K	1.0001K	11	1200	0.1	0.05	30	10	Range 1	0.03	0.01	0.003	0.005
1776-C4815	10 Meg	1.1111M	101.01K	10.01K	1.0001K	11	1200	0.1	0.05	30	5	Range 1	0.03	0.01	0.003	0.005
1776-C61	9 Meg	900 K	90 K	9 K	900	6	1200	0.1	0.1	30	10	Range 2	0.1	0.01	0.005	0.01
1776-C611	9 Meg	900 K	90 K	9 K	900	6	1200	0.1	0.05	30	10	Range 2	0.1	0.01	0.005	0.01
1776-C62	9 Meg	900 K	90 K	9 K	1 K	6	1200	0.1	0.1	30	10	Range 2	0.1	0.01	0.005	0.01
1776-C621	9 Meg	900 K	90 K	9 K	1 K	6	1200	0.1	0.05	30	10	Range 2	0.1	0.01	0.005	0.01
1776-C6217	9 Meg	900 K	90 K	9 K	1 K	6	1200	0.1	0.02	30	10	Range 2	0.1	0.01	0.005	0.01
1776-C742	9 Meg	900 K	90 K	9 K	1 K	7	1200	0.25	0.25	50	50	Range 2	0.5	0.04	0.02	0.04
1776-C74	9 Meg	900 K	90 K	9 K	1 K	7	1200	0.1	0.1	50	50	Range 2	0.5	0.04	0.02	0.04
1776-232	9 Meg	900 K	90 K	9 K	900	3	1200	0.25	0.25	50	50	Range 2	0.3	0.04	0.02	0.04
1776-23	9 Meg	900 K	90 K	9 K	900	3	1200	0.1	0.1	50	50	Range 2	0.2	0.02	0.01	0.02
1776-242	9 Meg	900 K	90 K	9 K	1 K	3	1200	0.25	0.25	50	50	Range 2	0.3	0.04	0.02	0.04
1776-24	9 Meg	900 K	90 K	9 K	1 K	3	1200	0.25	0.1	50	50	Range 2	0.2	0.02	0.01	0.02
1776-241	9 Meg	900 K	90 K	9 K	1 K	3	1200	0.25	0.05	50	50	Range 2	0.2	0.02	0.01	0.02
1776-105	9 Meg	900 K	90 K	10 K	N/A	4	1200	+0, -0.5	0.1	30	5	Range 2	0.02	0.01	0.005	0.01
1776-C10	9 Meg	900 K	90 K	10 K	N/A	9	1200	+0, -0.5	0.1	30	10	Range 2	0.02	0.01	0.005	0.01
1776-C105	9 Meg	900 K	90 K	10 K	N/A	9	1200	+0, -0.5	0.1	30	5	Range 2	0.02	0.01	0.005	0.01
1776-1	9 Meg	900 K	90 K	10 K	N/A	2	1200	0.25	0.05	30	10	Range 2	0.02	0.01	0.005	0.01
1776-14	9 Meg	900 K	90 K	10 K	N/A	2	1200	0.25	0.1	30	10	Range 2	0.02	0.01	0.005	0.01
1776-8	9.9 Meg	90 K	10 K	N/A	N/A	1	1200	0.25	0.1	30	25	Range 2	0.2	0.02	0.01	0.02
1776-9	9.9 Meg	90 K	10 K	N/A	N/A	1	1200	0.25	0.1	30	10	Range 2	0.02	0.01	0.005	0.01
1776-91	9.9 Meg	90 K	10 K	N/A	N/A	1	1200	0.25	0.05	30	10	Range 2	0.02	0.01	0.005	0.01
1776-912	9.9 Meg	90 K	10 K	N/A	N/A	1	1200	0.25	0.02	30	5	Range 2	0.02	0.01	0.005	0.01
1776-C4	10 Meg	1.1111M	101.01K	10.01K	1.0001K	8	1200	0.25	0.25	30	10	Range 2	0.1	0.01	0.005	0.01
1776-C44	10 Meg	1.1111M	101.01K	10.01K	1.0001K	8	1200	0.1	0.1	30	10	Range 2	0.1	0.01	0.005	0.01
1776-C441	10 Meg	1.1111M	101.01K	10.01K	1.0001K	8	1200	0.1	0.05	30	10	Range 2	0.1	0.01	0.005	0.01
1776-C34	10 Meg	1.1111M	101.01K	10.01K	1.0001K	8	1200	0.25	0.25	50	50	Range 2	0.5	0.04	0.02	0.04
1776-C532	900 K	90 K	9 K	900	N/A	5	750	0.25	0.25	25	25	Range 2	0.4	0.02	0.01	0.02
1776-C53	900 K	90 K	9 K	900	N/A	5	750	0.1	0.1	25	15	Range 2	0.3	0.02	0.01	0.02
1776-C542	900 K	90 K	9 K	1 K	N/A	5	750	0.25	0.25	25	25	Range 2	0.4	0.02	0.01	0.02
1776-C54	900 K	90 K	9 K	1 K	N/A	5	750	0.1	0.1	25	15	Range 2	0.3	0.02	0.01	0.02
1776-C541	900 K	90 K	9 K	1 K	N/A	5	750	0.1	0.05	25	15	Range 2	0.3	0.02	0.01	0.02

### Specifications:

(Numbers inside circles reference columns in Model No. table)

- ① **Ratio Tolerance:** Maximum ratio error. (See the specific Figures for the Ratio Definition).
- ② **Ratio Temperature Coefficient:** Maximum ratio TC error. (See the specific Figures for the Ratio Definition).  
Range 1: -40°C to +85°C.  
Range 2: 0°C to +70°C.
- ③ **Voltage Coefficient of Ratio (ppm/volt):** R1 in series with any combination of R2, R3, R4, and R5, 100 volts to rated voltage.
- ④ **Load Life:** Ratio stability of resistance under full load at +70°C, rated voltage applied to R1 in series with any combination of R2, R3, R4, and R5 for 2000 hrs.
- ⑤ **Shelf Stability of Ratio:** Six months at shelf conditions.
- ⑥ **Overvoltage:** Maximum voltage of 1.67 times rated DC voltage. Volts DC or peak AC applied to R1 and any combination of R2, R3, R4, and R5 in series with R1 for 10 seconds.
- ⑦ **Voltage Rating:** DC or RMS AC voltage applied to R1 in series with any combination of R2, R3, R4, and R5.

**Storage Temperature:** -40°C to +85°C.

**Applications Engineering**  
17271 North Umpqua Hwy.  
Roseburg, Oregon 97470-9422  
Phone: (541) 496-0700  
Fax: (541) 496-0408

**CADDOCK ELECTRONICS, INC.**

e-mail: caddock@caddock.com • web: www.caddock.com  
For Caddock Distributors listed by country see caddock.com/contact/dist.html

**Sales and Corporate Office**  
1717 Chicago Avenue  
Riverside, California 92507-2364  
Phone: (951) 788-1700  
Fax: (951) 369-1151



**New  
Smaller Models  
Lower Cost**

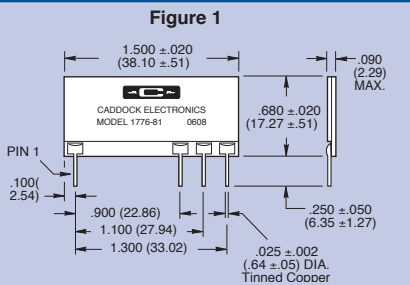
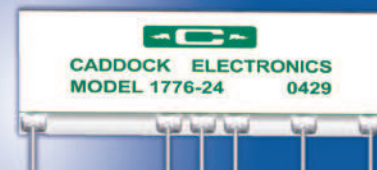
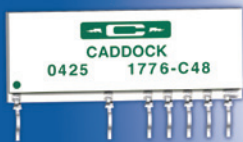

RATIO DEFINITION:  
ALL RESISTORS RATIO  
ONE ANOTHER

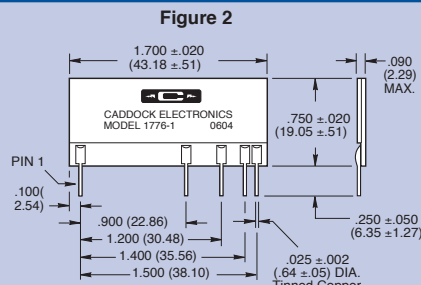
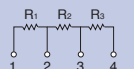

RATIO DEFINITION:  
ALL RESISTORS RATIO  
ONE ANOTHER

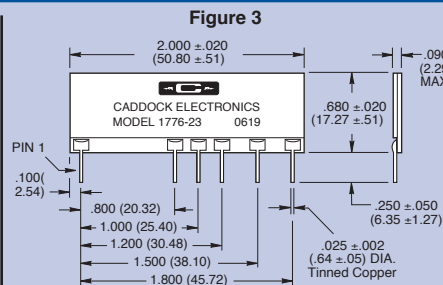
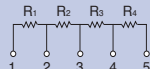

RATIO DEFINITION:  
ALL RESISTORS RATIO  
ONE ANOTHER

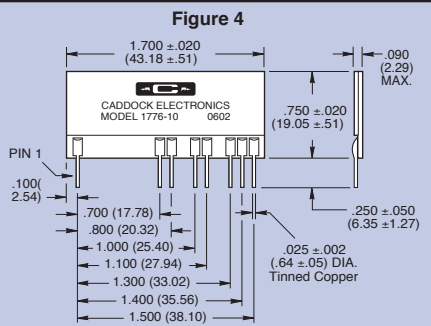
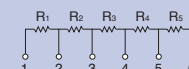

RATIO DEFINITION:  
ALL RESISTORS RATIO  
ONE ANOTHER

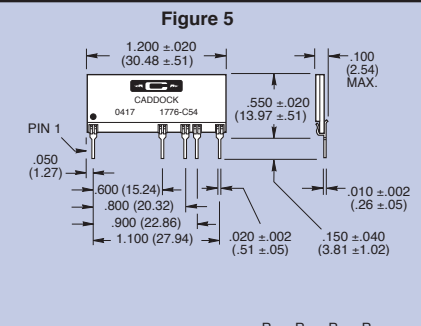
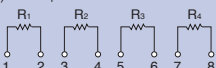

RATIO DEFINITION:  
ALL RESISTORS RATIO  
ONE ANOTHER

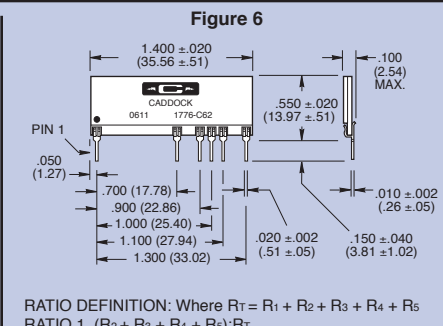
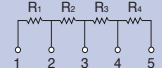

RATIO DEFINITION: Where  $R_T = R_1 + R_2 + R_3 + R_4 + R_5$   
RATIO 1  $(R_2 + R_3 + R_4 + R_5):R_T$   
RATIO 2  $(R_3 + R_4 + R_5):R_T$   
RATIO 3  $(R_4 + R_5):R_T$   
RATIO 4  $(R_5):R_T$

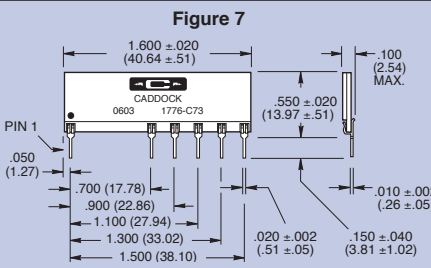
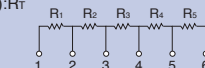

RATIO DEFINITION:  
ALL RESISTORS RATIO  
ONE ANOTHER

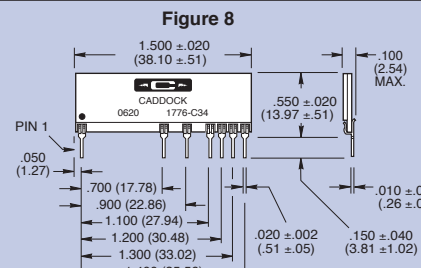
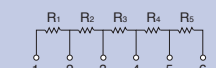

RATIO DEFINITION:  
RATIO 1  $R_1:R_2$   
RATIO 2  $R_1:R_3$   
RATIO 3  $R_1:R_4$   
RATIO 4  $R_1:R_5$

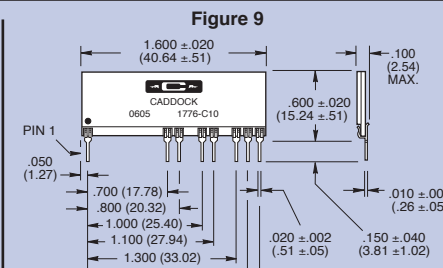
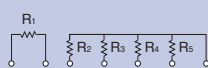

RATIO DEFINITION:  
ALL RESISTORS RATIO  
ONE ANOTHER

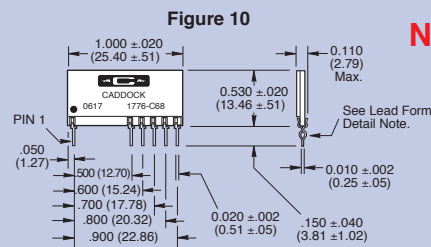
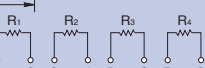

RATIO DEFINITION: Where  $R_T = R_1 + R_2 + R_3 + R_4 + R_5$   
RATIO 1  $(R_2 + R_3 + R_4 + R_5):R_T$   
RATIO 2  $(R_3 + R_4 + R_5):R_T$   
RATIO 3  $(R_4 + R_5):R_T$   
RATIO 4  $(R_5):R_T$

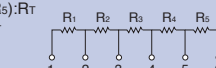

**New Smaller Models at Lower Cost**

**Lead Form Detail Note:** Lead form detail provides interference in the circuit board hole to achieve a vertical mount of the device. Recommended circuit board hole is nominally 0.039 inch (.99 mm).

DIMENSIONS IN INCHES AND (MILLIMETERS)

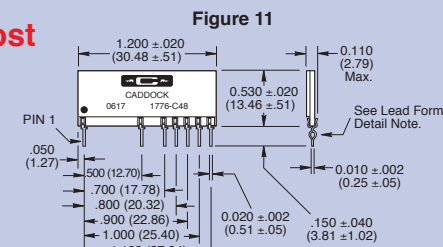

RATIO DEFINITION:  
RATIO 1  $R_1:R_2$   
RATIO 2  $R_1:R_3$   
RATIO 3  $R_1:R_4$   
RATIO 4  $R_1:R_5$

