



Chipsmall Limited consists of a professional team with an average of over 10 year of expertise in the distribution of electronic components. Based in Hongkong, we have already established firm and mutual-benefit business relationships with customers from,Europe,America and south Asia,supplying obsolete and hard-to-find components to meet their specific needs.

With the principle of “Quality Parts,Customers Priority,Honest Operation,and Considerate Service”,our business mainly focus on the distribution of electronic components. Line cards we deal with include Microchip,ALPS,ROHM,Xilinx,Pulse,ON,Everlight and Freescale. Main products comprise IC,Modules,Potentiometer,IC Socket,Relay,Connector.Our parts cover such applications as commercial,industrial, and automotives areas.

We are looking forward to setting up business relationship with you and hope to provide you with the best service and solution. Let us make a better world for our industry!



Contact us

Tel: +86-755-8981 8866 Fax: +86-755-8427 6832

Email & Skype: info@chipsmall.com Web: www.chipsmall.com

Address: A1208, Overseas Decoration Building, #122 Zhenhua RD., Futian, Shenzhen, China



**System pitch 5.08 mm (0.200 inch)
SL-SMT 5.08/02/90G 3.2SN BK BX**

Weidmüller Interface GmbH & Co. KG
Klingenbergstraße 16
D-32758 Detmold
Germany
Fon: +49 5231 14-0
Fax: +49 5231 14-2083
www.weidmueller.com



High-temperature-resistant male connector, packed in box or tape. In tape with 1.5 mm solder pin optimised for automatic assembly. 3.2 mm solder pin suitable for reflow and wave soldering. These male connectors can be labelled and coded.

- 400 V (IEC) / 300 V (UL)
- 19 A (IEC) / 15 A (UL)

General ordering data

Order No.	1780180000
Part designation	SL-SMT 5.08/02/90G 3.2SN BK BX
Version	PCB plug-in connector, male header, 5.08 mm, No. of poles: 2, 90°, Solder pin length: 3.2 mm, tinned, black, Reflow solder connection, Box
GTIN (EAN)	4032248165506
Qty.	100 pc(s).
Packaging	Box

System pitch 5.08 mm (0.200 inch) SL-SMT 5.08/02/90G 3.2SN BK BX

Weidmüller Interface GmbH & Co. KG
Klingenbergstraße 16
D-32758 Detmold
Germany
Fon: +49 5231 14-0
Fax: +49 5231 14-2083
www.weidmueller.com

Technical data

System parameters

Fitted to PCB	Reflow solder connection	Outgoing elbow	90°
Pitch in mm	5.08 mm	Pitch in inch	0.2 inch
No. of poles	2	Solder pin length	3.2 mm
Can be coded	Yes	No. of rows	1
Number of solder pins per pole	1	L1 in mm	5.08 mm
L1 in inch	0.2 inch		

Material data

Insulating material	LCP GF	Colour	black
Insulating material group	IIIa	Flammability class UL 94	V-0
Contact material	CuSn	Contact surface	tinned
Highest continuous operating temperature, min.	-25 °C	Highest continuous operating temperature, max.	100 °C
Max. relative humidity during storage	80 %		

DIN IEC rating data

Rated current, min. No. of poles (Tu=20°C)	19 A	Rated current, max. No. of poles (Tu=20°C)	15 A
Rated current, no. of poles (Tu=40°C), min.	16 A	Rated current, no. of poles (Tu=40°C), max.	13 A
Rated voltage at overvoltage category/pollution degree III/3	250 V	Rated impulse withstand voltage for overvoltage class/pollution severity III/3	4 kV
Rated voltage for overvoltage class/pollution severity III/2	320 V	Rated impulse withstand voltage for overvoltage class/pollution severity III/2	4 kV
Rated voltage for overvoltage class/pollution severity II/2	400 V	Rated impulse withstand voltage for overvoltage class/pollution severity II/2	4 kV

CSA rating data

Rated voltage (Use group B)	300 V	Rated current (use group B)	15 A
Rated voltage (use group D)	300 V	Rated current (use group D)	10 A

UL 1059 rating data

Rated voltage (use group B)	300 V	Rated current (use group B)	15 A
Rated voltage (use group D)	300 V	Rated current (use group D)	10 A

Approvals

Approvals institutes	CSA; GOSTME25; UR; ROHS
----------------------	-------------------------

Classifications

ETIM 3.0	EC001284	eClass 5.1	27-26-07-04
eClass 6.0	27-26-07-04		

Datasheet**System pitch 5.08 mm (0.200 inch)
SL-SMT 5.08/02/90G 3.2SN BK BX****Weidmüller Interface GmbH & Co. KG**
Klingenbergstraße 16
D-32758 Detmold
Germany
Fon: +49 5231 14-0
Fax: +49 5231 14-2083
www.weidmueller.com**Technical data****Notes**

Notes

- Additional colours on request
- Gold-plated contact surfaces on request
- Rated current related to rated cross-section and min. No. of poles.
- Diameter of solder eyelet $D = 1.4 \pm 0.1$ mm
- Diameter of solder eyelet $D = 1.5 \pm 0.1$ mm from 9-pole
- P on drg. = pitch
- Rated data refer only to the component itself. Clearance and creepage distances to other components are to be designed in accordance with the relevant application standards.

Datasheet

**System pitch 5.08 mm (0.200 inch)
SL-SMT 5.08/02/90G 3.2SN BK BX**

Weidmüller Interface GmbH & Co. KG
Klingenbergstraße 16
D-32758 Detmold
Germany
Fon: +49 5231 14-0
Fax: +49 5231 14-2083
www.weidmueller.com

Drawings

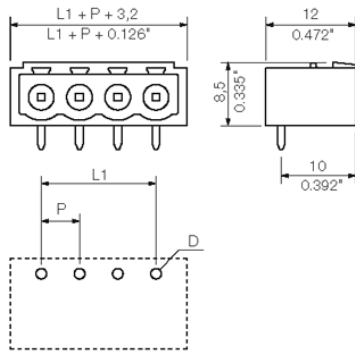

System pitch 5.08 mm (0.200 inch) SL-SMT 5.08/02/90G 3.2SN BK BX

Weidmüller Interface GmbH & Co. KG
Klingenbergstraße 16
D-32758 Detmold
Germany
Fon: +49 5231 14-0
Fax: +49 5231 14-2083
www.weidmueller.com

Counterpart

BLZP 5.08/225 SN



Clamping-yoke wire connection with right-angled (90° or 270°) or angled (225°) outlet direction. The female connectors provide space for labelling and can be coded. Can be fastened with flange or release latch. They feature an integrated plus/minus screw, protection against false insertion under clamping yoke. They are delivered with an opened clamping yoke.

- 0.2-2.5 mm² (IEC) / 26-12 AWG (UL)
- 400 V (IEC) / 300 V (UL)
- 17.5 A (IEC) / 10 A (UL)

General ordering data

Order No.	Part designation	Version	GTIN (EAN)	Qty.	Packaging
1946250000	BLZP 5.08/02/225 SN OR BX	PCB plug-in connector, female plug, 5.08 mm, No. of poles: 2, 225°, Clamping yoke connection, Clamping range, max.: 4 mm ² , Box	4032248621828	180 pc(s).	Box
1946560000	BLZP 5.08/02/225 SN BK BX	PCB plug-in connector, female plug, 5.08 mm, No. of poles: 2, 225°, Clamping yoke connection, Clamping range, max.: 4 mm ² , Box	4032248622337	180 pc(s).	Box

BLZP 5.08/180 SN



Female connectors with clamping yoke screw connection for conductor connection with straight (180°) outlet direction. The female connectors provide space for labelling and can be coded. Can be fastened with flange or release latch. They feature an integrated plus/minus screw, protection against false insertion under clamping yoke. They are delivered with an opened clamping yoke.

- 0.2-2.5 mm² (IEC) / 26-12 AWG (UL)
- 400 V (IEC) / 300 V (UL)
- 19 A (IEC) / 15 A (UL)

General ordering data

Order No.	Part designation	Version	GTIN (EAN)	Qty.	Packaging
1943810000	BLZP 5.08/02/180 SN BK BX	PCB plug-in connector, female plug, 5.08 mm, No. of poles: 2, 180°, Clamping yoke connection, Clamping range, max.: 4 mm ² , Box	4032248617821	100 pc(s).	Box
1943580000	BLZP 5.08/02/180 SN OR BX	PCB plug-in connector, female plug, 5.08 mm, No. of poles: 2, 180°, Clamping yoke connection, Clamping range, max.: 4 mm ² , Box	4032248617562	100 pc(s).	Box

System pitch 5.08 mm (0.200 inch) SL-SMT 5.08/02/90G 3.2SN BK BX

Weidmüller Interface GmbH & Co. KG
 Klingenbergstraße 16
 D-32758 Detmold
 Germany
 Fon: +49 5231 14-0
 Fax: +49 5231 14-2083
 www.weidmueller.com

Counterpart

BLZP 5.00/270 SN

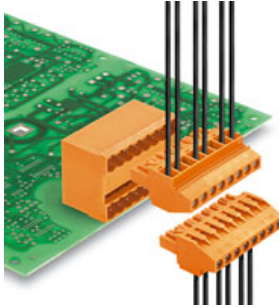

Socket connectors with clamping yoke screw connection for conductor connection with a right-angle (90° or 270°) outlet direction. The female connectors provide space for labelling and can be coded. Can be fastened with flange or release latch. They feature an integrated plus/minus screw, protection against false insertion under clamping yoke. They are delivered with an opened clamping yoke.

- 0.2-2.5 mm² (IEC) / 26-12 AWG (UL)
- 400 V (IEC) / 300 V (UL)
- 15 A (IEC) / 10 A (UL)

General ordering data

Order No.	Part designation	Version	GTIN (EAN)	Qty.	Packaging
1958870000	BLZP 5.00/02/270 SN OR BX	PCB plug-in connector, female plug, 5.00 mm, No. of poles: 2, 90°, Clamping yoke connection, Clamping range, max.: 4 mm ² , Box	4032248637706	180 pc(s).	Box
1959100000	BLZP 5.00/02/270 SN BK BX	PCB plug-in connector, female plug, 5.00 mm, No. of poles: 2, 90°, Clamping yoke connection, Clamping range, max.: 4 mm ² , Box	4032248638031	180 pc(s).	Box

BLF 5.08/90 SN



Just as reliable as the tried-and-true original, with innovation in detail:

The BLF 5.0x – the PUSH-IN version of the BLZ 5.0x socket block – features a new connection system and a more compact design. Weidmüller's innovative PUSH-IN spring connection features a trend-setting, tool-free wire connection system that is simple to operate.

In terms of versatility, the BLF 5.0x offers just as much as the older versions:

- The choice of three wire outlet directions offers you proven design flexibility for your applications.
- Four flange variations, including the patented release latch, allow for user-friendly unplugging designs.

General ordering data

Order No.	Part designation	Version	GTIN (EAN)	Qty.	Packaging
1001530000	BLF 5.08/02/90 SN OR BX	PCB plug-in connector, female plug, 5.08 mm, No. of poles: 2, 90°, PUSH IN, Clamping range, max.: 3.31 mm ² , Box	4032248693337	180 pc(s).	Box
1000030001	BLF 5.08/02/90 SN BK BX	PCB plug-in connector, female plug, 5.08 mm, No. of poles: 2, 90°, PUSH IN, Clamping range, max.: 3.31 mm ² , Box	4032248689965	180 pc(s).	Box

System pitch 5.08 mm (0.200 inch) SL-SMT 5.08/02/90G 3.2SN BK BX

Weidmüller Interface GmbH & Co. KG
 Klingenbergstraße 16
 D-32758 Detmold
 Germany
 Fon: +49 5231 14-0
 Fax: +49 5231 14-2083
 www.weidmueller.com

Counterpart

BLZ 5.00/270



Female connectors with clamping yoke screw connection. The female connectors provide space for labelling and can be coded. Packed in cardboard box.

- 0.20 - 2.5 mm² (IEC) / 26 - 12 AWG (UL)
- 400 V (IEC) / 300 V (UL)
- 15 A (IEC) / 10 A (UL)

General ordering data

Order No.	Part designation	Version	GTIN (EAN)	Qty.	Packaging
1637580000	BLZ 5.00/02/270 SN OR BX	PCB plug-in connector, female plug, 5.00 mm, No. of poles: 2, 270°, Clamping yoke connection, Clamping range, max.: 3.31 mm ² , Box	4008190274825	180 pc(s).	Box
1637810000	BLZ 5.00/02/270 SN BK BX	PCB plug-in connector, female plug, 5.00 mm, No. of poles: 2, 270°, Clamping yoke connection, Clamping range, max.: 3.31 mm ² , Box	4008190275051	180 pc(s).	Box

BLL 5.08/180



Female connector for PCB mounting. The solder pin length is optimised for wave flow soldering. Packed in cardboard box.

- 400 V (IEC) / 300 V (UL)
- 23 A (IEC) / 15 A (UL)

General ordering data

Order No.	Part designation	Version	GTIN (EAN)	Qty.	Packaging
1630710000	BLL 5.08/02/180 3.2SN OR BX	PCB plug-in connector, female header, 5.08 mm, No. of poles: 2, 180°, Solder pin length: 3.2 mm, tinned, Orange, Solder connection, Box	4008190204136	100 pc(s).	Box

System pitch 5.08 mm (0.200 inch) SL-SMT 5.08/02/90G 3.2SN BK BX

Weidmüller Interface GmbH & Co. KG
Klingenbergstraße 16
D-32758 Detmold
Germany
Fon: +49 5231 14-0
Fax: +49 5231 14-2083
www.weidmueller.com

Counterpart

BLZF 5.08/180



Female connectors for connecting conductors with tension clamp system, straight 180° outlet direction. The female connectors include space for labelling and can be coded. Packed in cardboard box.

- 0.20 - 2.5 mm² (IEC) / 26 - 12 AWG (UL)
- 400 V (IEC) / 300 V (UL)
- 17 A (IEC) / 15 A (UL)

General ordering data

Order No.	Part designation	Version	GTIN (EAN)	Qty.	Packaging
1707690000	BLZF 5.08/02/180 SN BK BX	PCB plug-in connector, female plug, 5.08 mm, No. of poles: 2, 180°, Tension clamp connection, Clamping range, max.: 3.31 mm ² , Box	4008190316693	180 pc(s).	Box
1707460000	BLZF 5.08/02/180 SN OR BX	PCB plug-in connector, female plug, 5.08 mm, No. of poles: 2, 180°, Tension clamp connection, Clamping range, max.: 3.31 mm ² , Box	4008190389628	180 pc(s).	Box

BLF 5.00/90 SN



Just as reliable as the tried-and-true original, with innovation in detail:

The BLF 5.0x – the PUSH-IN version of the BLZ 5.0x socket block – features a new connection system and a more compact design. Weidmüller's innovative PUSH-IN spring connection features a trend-setting, tool-free wire connection system that is simple to operate.

In terms of versatility, the BLF 5.0x offers just as much as the older versions:

- The choice of three wire outlet directions offers you proven design flexibility for your applications.
- Four flange variations, including the patented release latch, allow for user-friendly unplugging designs.

General ordering data

Order No.	Part designation	Version	GTIN (EAN)	Qty.	Packaging
1979270000	BLF 5.00/02/90 SN BK BX	PCB plug-in connector, female plug, 5.00 mm, No. of poles: 2, 90°, PUSH IN, Clamping range, max.: 3.31 mm ² , Box	4032248674442	180 pc(s).	Box
1980170000	BLF 5.00/02/90 SN OR BX	PCB plug-in connector, female plug, 5.00 mm, No. of poles: 2, 90°, PUSH IN, Clamping range, max.: 3.31 mm ² , Box	4032248675258	180 pc(s).	Box

System pitch 5.08 mm (0.200 inch) SL-SMT 5.08/02/90G 3.2SN BK BX

Weidmüller Interface GmbH & Co. KG
 Klingenbergstraße 16
 D-32758 Detmold
 Germany
 Fon: +49 5231 14-0
 Fax: +49 5231 14-2083
 www.weidmueller.com

Counterpart

BLIDC 5.08



Female connectors for conductor connection with IDC system. The female connectors provide space for labelling and can be coded. Packed in cardboard box.

- 0.35 - 0.75 mm² (IEC) / 22 - 20 AWG (UL)
- 400 V (IEC) / 300 V (UL)
- 11 A (IEC) / 5 A (UL)

General ordering data

Order No.	Part designation	Version	GTIN (EAN)	Qty.	Packaging
1724940000	BLIDC 5.08/02/180 SN OR BX	PCB plug-in connector, female plug, 5.08 mm, No. of poles: 2, 180°, IDC terminal, Clamping range, max.: 0.75 mm ² , Box	4008190377281	100 pc(s).	Box

BLZP 5.00/90 SN



Socket connectors with clamping yoke screw connection for conductor connection with a right-angle (90° or 270°) outlet direction. The female connectors provide space for labelling and can be coded. Can be fastened with flange or release latch. They feature an integrated plus/minus screw, protection against false insertion under clamping yoke. They are delivered with an opened clamping yoke.

- 0.2-2.5 mm² (IEC) / 26-12 AWG (UL)
- 400 V (IEC) / 300 V (UL)
- 15 A (IEC) / 10 A (UL)

General ordering data

Order No.	Part designation	Version	GTIN (EAN)	Qty.	Packaging
1958300000	BLZP 5.00/02/90 SN OR BX	PCB plug-in connector, female plug, 5.00 mm, No. of poles: 2, 90°, Clamping yoke connection, Clamping range, max.: 4 mm ² , Box	4032248637164	180 pc(s).	Box
1958650000	BLZP 5.00/02/90 SN BK BX	PCB plug-in connector, female plug, 5.00 mm, No. of poles: 2, 90°, Clamping yoke connection, Clamping range, max.: 4 mm ² , Box	4032248637386	180 pc(s).	Box

System pitch 5.08 mm (0.200 inch) SL-SMT 5.08/02/90G 3.2SN BK BX

Weidmüller Interface GmbH & Co. KG
 Klingenbergstraße 16
 D-32758 Detmold
 Germany
 Fon: +49 5231 14-0
 Fax: +49 5231 14-2083
 www.weidmueller.com

Counterpart

BLZ 5.00/90

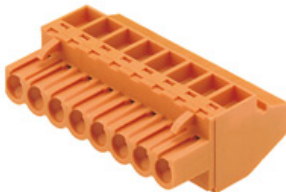

Female connectors with clamping yoke screw connection. The female connectors provide space for labelling and can be coded. Packed in cardboard box.

- 0.20 - 2.5 mm² (IEC) / 26 - 12 AWG (UL)
- 400 V (IEC) / 300 V (UL)
- 15 A (IEC) / 10 A (UL)

General ordering data

Order No.	Part designation	Version	GTIN (EAN)	Qty.	Packaging
1635940000	BLZ 5.00/02/90 SN OR BX	PCB plug-in connector, female plug, 5.00 mm, No. of poles: 2, 90°, Clamping yoke connection, Clamping range, max.: 3.31 mm ² , Box	4008190265854	180 pc(s).	Box
1636890000	BLZ 5.00/02/90 SN BK BX	PCB plug-in connector, female plug, 5.00 mm, No. of poles: 2, 90°, Clamping yoke connection, Clamping range, max.: 3.31 mm ² , Box	4008190274139	180 pc(s).	Box

BLZF 5.08/90



Female connectors for connecting conductors with tension clamp system. The female connectors include space for labelling and can be coded. Packed in cardboard box.

- 0.20 - 2.5 mm² (IEC) / 26 - 12 AWG (UL)
- 400 V (IEC) / 300 V (UL)
- 16.5 A (IEC) / 10 A (UL)

General ordering data

Order No.	Part designation	Version	GTIN (EAN)	Qty.	Packaging
1671020000	BLZF 5.08/02/90 SN BK BX	PCB plug-in connector, female plug, 5.08 mm, No. of poles: 2, 90°, Tension clamp connection, Clamping range, max.: 3.31 mm ² , Box	4008190432690	180 pc(s).	Box
1670790000	BLZF 5.08/02/90 SN OR BX	PCB plug-in connector, female plug, 5.08 mm, No. of poles: 2, 90°, Tension clamp connection, Clamping range, max.: 3.31 mm ² , Box	4008190432393	180 pc(s).	Box

System pitch 5.08 mm (0.200 inch) SL-SMT 5.08/02/90G 3.2SN BK BX

Weidmüller Interface GmbH & Co. KG
 Klingenbergstraße 16
 D-32758 Detmold
 Germany
 Fon: +49 5231 14-0
 Fax: +49 5231 14-2083
 www.weidmueller.com

Counterpart

BL 5.00



Female connectors for conductor connection in leaf spring system. Packed in cardboard box. The female connectors provide space for labelling. Packed in cardboard box.

- 0.2 - 1.5 mm² (IEC) / 26 - 14 AWG (UL)
- 400 V (IEC) / 300 V (UL)
- 11 A (IEC) / 10 A (UL)

General ordering data

Order No.	Part designation	Version	GTIN (EAN)	Qty.	Packaging
1762770000	BL 5.00/02/180 SN GY BX	PCB plug-in connector, female plug, 5.00 mm, No. of poles: 2, 180°, Leaf spring connection, Clamping range, max.: 2.08 mm ² , Box	4032248048687	100 pc(s).	Box
1723110000	BL 5.00/02/180 SN OR BX	PCB plug-in connector, female plug, 5.00 mm, No. of poles: 2, 180°, Leaf spring connection, Clamping range, max.: 2.08 mm ² , Box	4032248002511	100 pc(s).	Box
1730700000	BL 5.00/02/180 SN BK BX	PCB plug-in connector, female plug, 5.00 mm, No. of poles: 2, 180°, Leaf spring connection, Clamping range, max.: 2.08 mm ² , Box	4008190387334	100 pc(s).	Box

BLZP 5.00/180 SN



Female connectors with clamping yoke screw connection for conductor connection with straight (180°) outlet direction. The female connectors provide space for labelling and can be coded. Can be fastened with flange or release latch. They feature an integrated plus/minus screw, protection against false insertion under clamping yoke. They are delivered with an opened clamping yoke.

- 0.2-2.5 mm² (IEC) / 26-12 AWG (UL)
- 400 V (IEC) / 300 V (UL)
- 19 A (IEC) / 15 A (UL)

General ordering data

Order No.	Part designation	Version	GTIN (EAN)	Qty.	Packaging
1955570000	BLZP 5.00/02/180 SN BK BX	PCB plug-in connector, female plug, 5.00 mm, No. of poles: 2, 180°, Clamping yoke connection, Clamping range, max.: 4 mm ² , Box	4032248634064	100 pc(s).	Box
1954490000	BLZP 5.00/02/180 SN OR BX	PCB plug-in connector, female plug, 5.00 mm, No. of poles: 2, 180°, Clamping yoke	4032248633203	100 pc(s).	Box

System pitch 5.08 mm (0.200 inch) SL-SMT 5.08/02/90G 3.2SN BK BX

Weidmüller Interface GmbH & Co. KG
 Klingenbergstraße 16
 D-32758 Detmold
 Germany
 Fon: +49 5231 14-0
 Fax: +49 5231 14-2083
 www.weidmueller.com

Counterpart

connection, Clamping range,
 max.: 4 mm², Box

BLIDC 5.08B



Female connectors for conductor connection with IDC system. The female connectors provide space for labelling and can be coded. Packed in cardboard box.

- 0.35 - 0.75 mm² (IEC) / 22 - 20 AWG (UL)
- 400 V (IEC) / 300 V (UL)
- 11 A (IEC) / 5 A (UL)

General ordering data

Order No.	Part designation	Version	GTIN (EAN)	Qty.	Packaging
1759610000	BLIDC 5.08/02/180B SN BK BX	PCB plug-in connector, female plug, 5.08 mm, No. of poles: 2, 180°, IDC terminal, Clamping range, max.: 0.75 mm ² , Box	4032248069842	100 pc(s).	Box
1759500000	BLIDC 5.08/02/180B SN OR BX	PCB plug-in connector, female plug, 5.08 mm, No. of poles: 2, 180°, IDC terminal, Clamping range, max.: 0.75 mm ² , Box	4032248069736	100 pc(s).	Box

BLZP 5.08/270 SN

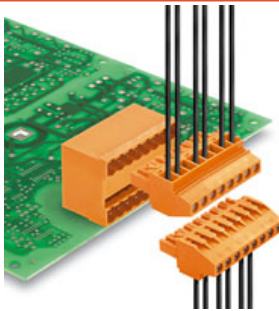

Socket connectors with clamping yoke screw connection for conductor connection with a right-angle (90° or 270°) outlet direction. The female connectors provide space for labelling and can be coded. Can be fastened with flange or release latch. They feature an integrated plus/minus screw, protection against false insertion under clamping yoke. They are delivered with an opened clamping yoke.

- 0.2-2.5 mm² (IEC) / 26-12 AWG (UL)
- 400 V (IEC) / 300 V (UL)
- 15 A (IEC) / 10 A (UL)

General ordering data

Order No.	Part designation	Version	GTIN (EAN)	Qty.	Packaging
1949020000	BLZP 5.08/02/270 SN BK BX	PCB plug-in connector, female plug, 5.08 mm, No. of poles: 2, 270°, Clamping yoke connection, Clamping range, max.: 4 mm ² , Box	4032248626472	180 pc(s).	Box
1948790000	BLZP 5.08/02/270 SN OR BX	PCB plug-in connector, female plug, 5.08 mm, No. of poles: 2, 270°, Clamping yoke connection, Clamping range, max.: 4 mm ² , Box	4032248626243	180 pc(s).	Box

System pitch 5.08 mm (0.200 inch) SL-SMT 5.08/02/90G 3.2SN BK BX

Weidmüller Interface GmbH & Co. KG
 Klingenbergstraße 16
 D-32758 Detmold
 Germany
 Fon: +49 5231 14-0
 Fax: +49 5231 14-2083
 www.weidmueller.com

Counterpart

BLZFS 5.00/180



Female connectors for connecting conductors with tension clamp system, straight 180° outlet direction in thin-element design. The female connectors include space for labelling and can be coded. Packed in cardboard box.

- 0.20 - 2.5 mm² (IEC) / 26 - 14 AWG (UL)
- 400 V (IEC) / 300 V (UL)
- 17 A (IEC) / 10 A (UL)

General ordering data

Order No.	Part designation	Version	GTIN (EAN)	Qty.	Packaging
1696370000	BLZFS 5.00/02/180 SN OR BX	PCB plug-in connector, female plug, 5.00 mm, No. of poles: 2, 180°, Tension clamp connection, Clamping range, max.: 2.5 mm ² , Box	4008190878399	100 pc(s).	Box
1696600000	BLZFS 5.00/02/180 SN BK BX	PCB plug-in connector, female plug, 5.00 mm, No. of poles: 2, 180°, Tension clamp connection, Clamping range, max.: 2.5 mm ² , Box	4008190878627	100 pc(s).	Box

BL 5.08



Female connectors for conductor connection in leaf spring system. Packed in cardboard box. The female connectors provide space for labelling. Packed in cardboard box.

- 0.2 - 1.5 mm² (IEC) / 26 - 14 AWG (UL)
- 400 V (IEC) / 300 V (UL)
- 11 A (IEC) / 10 A (UL)

General ordering data

Order No.	Part designation	Version	GTIN (EAN)	Qty.	Packaging
1716470000	BL 5.08/02/180 SN BK BX	PCB plug-in connector, female plug, 5.08 mm, No. of poles: 2, 180°, Leaf spring connection, Clamping range, max.: 2.08 mm ² , Box	4008190376512	100 pc(s).	Box
1716320000	BL 5.08/02/180 SN OR BX	PCB plug-in connector, female plug, 5.08 mm, No. of poles: 2, 180°, Leaf spring connection, Clamping range, max.: 2.08 mm ² , Box	4008190376345	100 pc(s).	Box
1723830000	BL 5.08/02/180 SN DKGX BX	PCB plug-in connector, female plug, 5.08 mm, No. of poles: 2, 180°, Leaf spring connection,	4008190376192	100 pc(s).	Box

System pitch 5.08 mm (0.200 inch) SL-SMT 5.08/02/90G 3.2SN BK BX

Weidmüller Interface GmbH & Co. KG
 Klingenbergstraße 16
 D-32758 Detmold
 Germany
 Fon: +49 5231 14-0
 Fax: +49 5231 14-2083
 www.weidmueller.com

Counterpart

Clamping range, max.: 2.08
 mm², Box

BLZ 5.00/180



Female connectors with clamping yoke screw connection for conductor connection with straight outlet direction. The female connectors provide space for labelling and can be coded. Packed in cardboard box.

- 0.20 - 2.5 mm² (IEC) / 26 - 12 AWG (UL)
- 400 V (IEC) / 300 V (UL)
- 19 A (IEC) / 15 A (UL)

General ordering data

Order No.	Part designation	Version	GTIN (EAN)	Qty.	Packaging
1571350000	BLZ 5.00/02/180 SN OR BX	PCB plug-in connector, female plug, 5.00 mm, No. of poles: 2, 180°, Clamping yoke connection, Clamping range, max.: 3.31 mm ² , Box	4008190172534	100 pc(s).	Box
1625610000	BLZ 5.00/02/180 SN BK BX	PCB plug-in connector, female plug, 5.00 mm, No. of poles: 2, 180°, Clamping yoke connection, Clamping range, max.: 3.31 mm ² , Box	4008190196912	100 pc(s).	Box

BLT 5.08

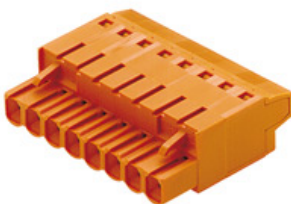

Female connectors with TOP screw system for connecting conductors with straight 180° outlet direction. The female connectors include space for labelling and can be coded. Packed in cardboard box.

- 0.20 - 2.5 mm² (IEC) / 26 - 14 AWG (UL)
- 400 V (IEC) / 300 V (UL)
- 17 A (IEC) / 10 A (UL)

General ordering data

Order No.	Part designation	Version	GTIN (EAN)	Qty.	Packaging
1499510000	BLT 5.08/02/180 SN BK BX	PCB plug-in connector, female plug, 5.08 mm, No. of poles: 2, 180°, TOP connection, Clamping range, max.: 2.5 mm ² , Box	4008190861704	180 pc(s).	Box
1499560000	BLT 5.08/02/180 SN OR BX	PCB plug-in connector, female plug, 5.08 mm, No. of poles: 2, 180°, TOP connection,	4008190060640	180 pc(s).	Box

System pitch 5.08 mm (0.200 inch) SL-SMT 5.08/02/90G 3.2SN BK BX

Weidmüller Interface GmbH & Co. KG
 Klingenbergstraße 16
 D-32758 Detmold
 Germany
 Fon: +49 5231 14-0
 Fax: +49 5231 14-2083
 www.weidmueller.com

Counterpart

Clamping range, max.: 2.5
mm², Box

BLC 5.08R

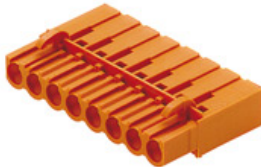

Female connectors for conductor connection with crimp connection system. The female connectors provide space for labelling and can be coded. Packed in cardboard box.

- 0.25 - 2.5 mm² (IEC) / 26 - 14 AWG (UL)
- 400 V (IEC) / 300 V (UL)
- 21 A (IEC) / 10 A (UL)

General ordering data

Order No.	Part designation	Version	GTIN (EAN)	Qty.	Packaging
1610490000	BLC 5.08/02/180R OR BX	PCB plug-in connector, female plug, 5.08 mm, No. of poles: 2, 180°, Crimp connection, Clamping range, max.: 2.5 mm ² , Box	4008190057114	100 pc(s).	Box
1711960000	BLC 5.08/02/180R BK BX	PCB plug-in connector, female plug, 5.08 mm, No. of poles: 2, 180°, Crimp connection, Clamping range, max.: 2.5 mm ² , Box	4008190934972	100 pc(s).	Box

BLZ 5.08/180



Female connectors with clamping yoke screw connection for conductor connection with straight outlet direction. The female connectors provide space for labelling and can be coded. Packed in cardboard box.

- 0.20 - 2.5 mm² (IEC) / 26 - 12 AWG (UL)
- 400 V (IEC) / 300 V (UL)
- 19 A (IEC) / 15 A (UL)

General ordering data

Order No.	Part designation	Version	GTIN (EAN)	Qty.	Packaging
1526460000	BLZ 5.08/02/180 SN OR BX	PCB plug-in connector, female plug, 5.08 mm, No. of poles: 2, 180°, Clamping yoke connection, Clamping range, max.: 3.31 mm ² , Box	4008190155834	100 pc(s).	Box
1526410000	BLZ 5.08/02/180 SN BK BX	PCB plug-in connector, female plug, 5.08 mm, No. of poles: 2, 180°, Clamping yoke	4008190025038	100 pc(s).	Box

System pitch 5.08 mm (0.200 inch) SL-SMT 5.08/02/90G 3.2SN BK BX

Weidmüller Interface GmbH & Co. KG
 Klingenbergstraße 16
 D-32758 Detmold
 Germany
 Fon: +49 5231 14-0
 Fax: +49 5231 14-2083
 www.weidmueller.com

Counterpart

connection, Clamping range,
 max.: 3.31 mm², Box

BLDT 5.08



Female connectors with two clamping yoke screw connections per pole for conductor connection with 90° & 270° outlet direction. The female connectors provide space for labelling and can be coded. Packed in cardboard box.

- 0.20 - 2.5 mm² (IEC) / 26 - 12 AWG (UL)
- 400 V (IEC) / 300 V (UL)
- 14 A (IEC) / 10 A (UL)

General ordering data

Order No.	Part designation	Version	GTIN (EAN)	Qty.	Packaging
1660710000	BLDT 5.08/02/- SN BK BX	PCB plug-in connector, female plug, 5.08 mm, No. of poles: 2, 90°/270°, Clamping yoke connection, Clamping range, max.: 3.31 mm ² , Box	4008190417161	100 pc(s).	Box
1644730000	BLDT 5.08/02/- SN OR BX	PCB plug-in connector, female plug, 5.08 mm, No. of poles: 2, 90°/270°, Clamping yoke connection, Clamping range, max.: 3.31 mm ² , Box	4008190283940	100 pc(s).	Box

BLZ 5.08/90



Female connectors with clamping yoke screw connection. The female connectors provide space for labelling and can be coded. Packed in cardboard box.

- 0.20 - 2.5 mm² (IEC) / 26 - 12 AWG (UL)
- 400 V (IEC) / 300 V (UL)
- 15 A (IEC) / 10 A (UL)

General ordering data

Order No.	Part designation	Version	GTIN (EAN)	Qty.	Packaging
1552760000	BLZ 5.08/02/90 SN OR BX	PCB plug-in connector, female plug, 5.08 mm, No. of poles: 2, 90°, Clamping yoke connection, Clamping range, max.: 3.31 mm ² , Box	4008190151256	180 pc(s).	Box
1552710000	BLZ 5.08/02/90 SN BK BX	PCB plug-in connector, female plug, 5.08 mm, No. of poles: 2, 90°, Clamping yoke connection,	4008190267704	180 pc(s).	Box

System pitch 5.08 mm (0.200 inch) SL-SMT 5.08/02/90G 3.2SN BK BX

Weidmüller Interface GmbH & Co. KG
 Klingenbergstraße 16
 D-32758 Detmold
 Germany
 Fon: +49 5231 14-0
 Fax: +49 5231 14-2083
 www.weidmueller.com

Counterpart

Clamping range, max.: 3.31
 mm², Box

BLL 5.08/90



Female connector for PCB mounting. The solder pin length is optimised for wave flow soldering. Packed in cardboard box.

- 400 V (IEC) / 300 V (UL)
- 23 A (IEC) / 15 A (UL)

General ordering data

Order No.	Part designation	Version	GTIN (EAN)	Qty.	Packaging
1622940000	BLL 5.08/02/90 3.2SN OR BX	PCB plug-in connector, female header, 5.08 mm, No. of poles: 2, 90°, Solder pin length: 3.2 mm, tinned, Orange, Solder connection, Box	4008190194000	100 pc(s).	Box

BLZ 5.08/225



Female connectors with clamping yoke screw connection for conductor connection with 225° outlet direction. The female connectors provide space for labelling and can be coded. Packed in cardboard box.

- 0.20 - 2.5 mm² (IEC) / 26 - 12 AWG (UL)
- 400 V (IEC) / 300 V (UL)
- 16.5 A (IEC) / 10 A (UL)

General ordering data

Order No.	Part designation	Version	GTIN (EAN)	Qty.	Packaging
1741870000	BLZ 5.08/02/225 SN BK BX	PCB plug-in connector, female plug, 5.08 mm, No. of poles: 2, 225°, Clamping yoke connection, Clamping range, max.: 3.31 mm ² , Box	4008190248727	180 pc(s).	Box
1741640000	BLZ 5.08/02/225 SN OR BX	PCB plug-in connector, female plug, 5.08 mm, No. of poles: 2, 225°, Clamping yoke connection, Clamping range, max.: 3.31 mm ² , Box	4008190206147	180 pc(s).	Box

System pitch 5.08 mm (0.200 inch) SL-SMT 5.08/02/90G 3.2SN BK BX

Weidmüller Interface GmbH & Co. KG
Klingenbergstraße 16
D-32758 Detmold
Germany
Fon: +49 5231 14-0
Fax: +49 5231 14-2083
www.weidmueller.com

Counterpart

BLZ 5.08/270



Female connectors with clamping yoke screw connection. The female connectors provide space for labelling and can be coded. Packed in cardboard box.

- 0.20 - 2.5 mm² (IEC) / 26 - 12 AWG (UL)
- 400 V (IEC) / 300 V (UL)
- 15 A (IEC) / 10 A (UL)

General ordering data

Order No.	Part designation	Version	GTIN (EAN)	Qty.	Packaging
1557310000	BLZ 5.08/02/270 SN BK BX	PCB plug-in connector, female plug, 5.08 mm, No. of poles: 2, 270°, Clamping yoke connection, Clamping range, max.: 3.31 mm ² , Box	4008190269425	180 pc(s).	Box
1557360000	BLZ 5.08/02/270 SN OR BX	PCB plug-in connector, female plug, 5.08 mm, No. of poles: 2, 270°, Clamping yoke connection, Clamping range, max.: 3.31 mm ² , Box	4008190118167	180 pc(s).	Box

BLZF 5.08/270



Female connectors for connecting conductors with tension clamp system. The female connectors include space for labelling and can be coded. Packed in cardboard box.

- 0.20 - 2.5 mm² (IEC) / 26 - 12 AWG (UL)
- 400 V (IEC) / 300 V (UL)
- 16.5 A (IEC) / 10 A (UL)

General ordering data

Order No.	Part designation	Version	GTIN (EAN)	Qty.	Packaging
1672170000	BLZF 5.08/02/270 SN BK BX	PCB plug-in connector, female plug, 5.08 mm, No. of poles: 2, 270°, Tension clamp connection, Clamping range, max.: 3.31 mm ² , Box	4008190433888	180 pc(s).	Box
1671940000	BLZF 5.08/02/270 SN OR BX	PCB plug-in connector, female plug, 5.08 mm, No. of poles: 2, 270°, Tension clamp connection, Clamping range, max.: 3.31 mm ² , Box	4008190433659	180 pc(s).	Box

System pitch 5.08 mm (0.200 inch) SL-SMT 5.08/02/90G 3.2SN BK BX

Weidmüller Interface GmbH & Co. KG
Klingenbergstraße 16
D-32758 Detmold
Germany
Fon: +49 5231 14-0
Fax: +49 5231 14-2083
www.weidmueller.com

Counterpart

BLZP 5.08/270F SN



Socket connectors with clamping yoke screw connection for conductor connection with a right-angle (90° or 270°) outlet direction. The female connectors provide space for labelling and can be coded. Can be fastened with flange or release latch. They feature an integrated plus/minus screw, protection against false insertion under clamping yoke. They are delivered with an opened clamping yoke.

- 0.2-2.5 mm² (IEC) / 26-12 AWG (UL)
- 400 V (IEC) / 300 V (UL)
- 15 A (IEC) / 10 A (UL)

General ordering data

Order No.	Part designation	Version	GTIN (EAN)	Qty.	Packaging
1950310000	BLZP 5.08/02/270F SN OR BX	PCB plug-in connector, female plug, 5.08 mm, No. of poles: 2, 270°, Clamping yoke connection, Clamping range, max.: 4 mm ² , Box	4032248628421	90 pc(s).	Box
1950550000	BLZP 5.08/02/270F SN BK BX	PCB plug-in connector, female plug, 5.08 mm, No. of poles: 2, 270°, Clamping yoke connection, Clamping range, max.: 4 mm ² , Box	4032248628674	90 pc(s).	Box

BLZP 5.08/180F SN



Female connectors with clamping yoke screw connection for conductor connection with straight (180°) outlet direction. The female connectors provide space for labelling and can be coded. Can be fastened with flange or release latch. They feature an integrated plus/minus screw, protection against false insertion under clamping yoke. They are delivered with an opened clamping yoke.

- 0.2-2.5 mm² (IEC) / 26-12 AWG (UL)
- 400 V (IEC) / 300 V (UL)
- 19 A (IEC) / 15 A (UL)

General ordering data

Order No.	Part designation	Version	GTIN (EAN)	Qty.	Packaging
1944090000	BLZP 5.08/02/180F SN OR BX	PCB plug-in connector, female plug, 5.08 mm, No. of poles: 2, 180°, Clamping yoke connection, Clamping range, max.: 4 mm ² , Box	4032248617470	100 pc(s).	Box
1944330000	BLZP 5.08/02/180F SN BK BX	PCB plug-in connector, female plug, 5.08 mm, No. of poles: 2, 180°, Clamping yoke connection, Clamping range, max.: 4 mm ² , Box	4032248618903	100 pc(s).	Box

System pitch 5.08 mm (0.200 inch) SL-SMT 5.08/02/90G 3.2SN BK BX

Weidmüller Interface GmbH & Co. KG
 Klingenbergstraße 16
 D-32758 Detmold
 Germany
 Fon: +49 5231 14-0
 Fax: +49 5231 14-2083
 www.weidmueller.com

Counterpart

BLZP 5.00/270F SN

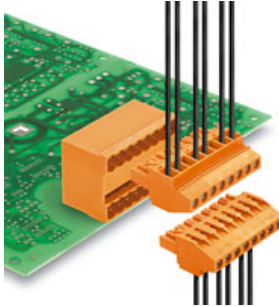

Socket connectors with clamping yoke screw connection for conductor connection with a right-angle (90° or 270°) outlet direction. The female connectors provide space for labelling and can be coded. Can be fastened with flange or release latch. They feature an integrated plus/minus screw, protection against false insertion under clamping yoke. They are delivered with an opened clamping yoke.

- 0.2-2.5 mm² (IEC) / 26-12 AWG (UL)
- 400 V (IEC) / 300 V (UL)
- 15 A (IEC) / 10 A (UL)

General ordering data

Order No.	Part designation	Version	GTIN (EAN)	Qty.	Packaging
1960460000	BLZP 5.00/02/270F SN OR BX	PCB plug-in connector, female plug, 5.00 mm, No. of poles: 2, 90°, Clamping yoke connection, Clamping range, max.: 4 mm ² , Box	4032248639328	90 pc(s).	Box
1960730000	BLZP 5.00/02/270F SN BK BX	PCB plug-in connector, female plug, 5.00 mm, No. of poles: 2, 90°, Clamping yoke connection, Clamping range, max.: 4 mm ² , Box	4032248639724	90 pc(s).	Box

BLZ 5.00/90B



Female connectors with clamping yoke screw connection. The female connectors provide space for labelling and can be coded. Packed in cardboard box.

- 0.20 - 2.5 mm² (IEC) / 26 - 12 AWG (UL)
- 400 V (IEC) / 300 V (UL)
- 15 A (IEC) / 10 A (UL)

General ordering data

Order No.	Part designation	Version	GTIN (EAN)	Qty.	Packaging
1637120000	BLZ 5.00/02/90B SN OR BX	PCB plug-in connector, female plug, 5.00 mm, No. of poles: 2, 90°, Clamping yoke connection, Clamping range, max.: 3.31 mm ² , Box	4008190274368	150 pc(s).	Box

**System pitch 5.08 mm (0.200 inch)
SL-SMT 5.08/02/90G 3.2SN BK BX**

Weidmüller Interface GmbH & Co. KG
Klingenbergstraße 16
D-32758 Detmold
Germany
Fon: +49 5231 14-0
Fax: +49 5231 14-2083
www.weidmueller.com

Counterpart
BLZ 5.08/180LH

Socket connectors with clamping yoke screw connection for conductor connection with 270° outlet direction and release lever or release latch mechanism. The female connectors provide space for labelling and can be coded. Packed in cardboard box.br/>

- 0.20–1.5 mm² (IEC) / 26–12 AWG (UL)
- 400 V (IEC) / 300 V (UL)
- 19 A (IEC) / 15 A (UL)

General ordering data

Order No.	Part designation	Version	GTIN (EAN)	Qty.	Packaging
1893600000	BLZ 5.08/02/180LH SN BK BX	PCB plug-in connector, female plug, 5.08 mm, No. of poles: 2, 180°, Clamping yoke connection, Clamping range, max.: 3.31 mm ² , Box	4032248507788	100 pc(s).	Box
1892190000	BLZ 5.08/02/180LH SN OR BX	PCB plug-in connector, female plug, 5.08 mm, No. of poles: 2, 180°, Clamping yoke connection, Clamping range, max.: 3.31 mm ² , Box	4032248505517	100 pc(s).	Box

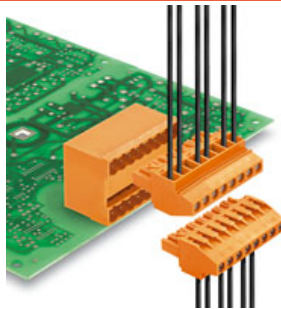
BLZP 5.08/90F SN

Socket connectors with clamping yoke screw connection for conductor connection with a right-angle (90° or 270°) outlet direction. The female connectors provide space for labelling and can be coded. Can be fastened with flange or release latch. They feature an integrated plus/minus screw, protection against false insertion under clamping yoke. They are delivered with an opened clamping yoke.

- 0.2-2.5 mm² (IEC) / 26-12 AWG (UL)
- 400 V (IEC) / 300 V (UL)
- 15 A (IEC) / 10 A (UL)

General ordering data

Order No.	Part designation	Version	GTIN (EAN)	Qty.	Packaging
1949800000	BLZP 5.08/02/90F SN OR BX	PCB plug-in connector, female plug, 5.08 mm, No. of poles: 2, 90°, Clamping yoke connection, Clamping range, max.: 4 mm ² , Box	4032248627721	90 pc(s).	Box
1950040000	BLZP 5.08/02/90F SN BK BX	PCB plug-in connector, female plug, 5.08 mm, No. of poles: 2, 90°, Clamping yoke connection, Clamping range, max.: 4 mm ² , Box	4032248627974	90 pc(s).	Box

System pitch 5.08 mm (0.200 inch) SL-SMT 5.08/02/90G 3.2SN BK BX

Weidmüller Interface GmbH & Co. KG
 Klingenbergstraße 16
 D-32758 Detmold
 Germany
 Fon: +49 5231 14-0
 Fax: +49 5231 14-2083
 www.weidmueller.com

Counterpart

BLZP 5.00/180F SN



Female connectors with clamping yoke screw connection for conductor connection with straight (180°) outlet direction. The female connectors provide space for labelling and can be coded. Can be fastened with flange or release latch. They feature an integrated plus/minus screw, protection against false insertion under clamping yoke. They are delivered with an opened clamping yoke.

- 0.2-2.5 mm² (IEC) / 26-12 AWG (UL)
- 400 V (IEC) / 300 V (UL)
- 19 A (IEC) / 15 A (UL)

General ordering data

Order No.	Part designation	Version	GTIN (EAN)	Qty.	Packaging
1956030000	BLZP 5.00/02/180F SN BK BX	PCB plug-in connector, female plug, 5.00 mm, No. of poles: 2, 180°, Clamping yoke connection, Clamping range, max.: 4 mm ² , Box	4032248634606	100 pc(s).	Box
1955800000	BLZP 5.00/02/180F SN OR BX	PCB plug-in connector, female plug, 5.00 mm, No. of poles: 2, 180°, Clamping yoke connection, Clamping range, max.: 4 mm ² , Box	4032248634347	100 pc(s).	Box

BLZP 5.00/270LH SN



Socket connectors with clamping yoke screw connection for conductor connection with a right-angle (90° or 270°) outlet direction. The female connectors provide space for labelling and can be coded. Can be fastened with flange or release latch. They feature an integrated plus/minus screw, protection against false insertion under clamping yoke. They are delivered with an opened clamping yoke.

- 0.2-2.5 mm² (IEC) / 26-12 AWG (UL)
- 400 V (IEC) / 300 V (UL)
- 15 A (IEC) / 10 A (UL)

General ordering data

Order No.	Part designation	Version	GTIN (EAN)	Qty.	Packaging
1961670000	BLZP 5.00/02/270LH SN BK BX	PCB plug-in connector, female plug, 5.00 mm, No. of poles: 2, 90°, Clamping yoke connection, Clamping range, max.: 4 mm ² , Box	4032248640942	90 pc(s).	Box
1961440000	BLZP 5.00/02/270LH SN OR BX	PCB plug-in connector, female plug, 5.00 mm, No. of poles: 2, 90°, Clamping yoke connection, Clamping range, max.: 4 mm ² , Box	4032248640713	90 pc(s).	Box

**System pitch 5.08 mm (0.200 inch)
SL-SMT 5.08/02/90G 3.2SN BK BX**

Weidmüller Interface GmbH & Co. KG
Klingenbergstraße 16
D-32758 Detmold
Germany
Fon: +49 5231 14-0
Fax: +49 5231 14-2083
www.weidmueller.com

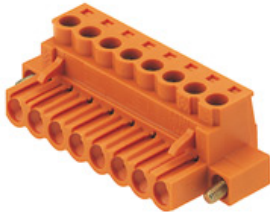
Counterpart
BLZ 5.08/180F

Female connectors with clamping yoke screw connection for conductor connection with straight outlet direction. The female connectors provide space for labelling and can be coded. Packed in cardboard box.

- 0.20 - 2.5 mm² (IEC) / 26 - 12 AWG (UL)
- 400 V (IEC) / 300 V (UL)
- 19 A (IEC) / 15 A (UL)

General ordering data

Order No.	Part designation	Version	GTIN (EAN)	Qty.	Packaging
1803040000	BLZ 5.08/02/180F SN BK BX	PCB plug-in connector, female plug, 5.08 mm, No. of poles: 2, 180°, Clamping yoke connection, Clamping range, max.: 3.31 mm ² , Box	4032248258147	100 pc(s).	Box
1802830000	BLZ 5.08/02/180F SN OR BX	PCB plug-in connector, female plug, 5.08 mm, No. of poles: 2, 180°, Clamping yoke connection, Clamping range, max.: 3.31 mm ² , Box	4032248257676	100 pc(s).	Box

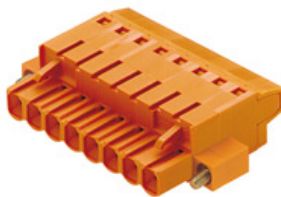
BLT 5.08F

Female connectors with TOP screw system for connecting conductors with straight 180° outlet direction. The female connectors include space for labelling and can be coded. Packed in cardboard box.

- 0.20 - 2.5 mm² (IEC) / 26 - 14 AWG (UL)
- 400 V (IEC) / 300 V (UL)
- 17 A (IEC) / 10 A (UL)

General ordering data

Order No.	Part designation	Version	GTIN (EAN)	Qty.	Packaging
1843990000	BLT 5.08/02/180F SN OR BX	PCB plug-in connector, female plug, 5.08 mm, No. of poles: 2, 180°, TOP connection, Clamping range, max.: 2.5 mm ² , Box	4032248355914	90 pc(s).	Box
1844220000	BLT 5.08/02/180F SN BK BX	PCB plug-in connector, female plug, 5.08 mm, No. of poles: 2, 180°, TOP connection, Clamping range, max.: 2.5 mm ² , Box	4032248356140	90 pc(s).	Box

System pitch 5.08 mm (0.200 inch) SL-SMT 5.08/02/90G 3.2SN BK BX

Weidmüller Interface GmbH & Co. KG
 Klingenbergstraße 16
 D-32758 Detmold
 Germany
 Fon: +49 5231 14-0
 Fax: +49 5231 14-2083
 www.weidmueller.com

Counterpart

BLL 5.08/90FI



Female connector for PCB mounting. The solder pin length is optimised for wave flow soldering. Packed in cardboard box.

- 400 V (IEC) / 300 V (UL)
- 23 A (IEC) / 15 A (UL)

General ordering data

Order No.	Part designation	Version	GTIN (EAN)	Qty.	Packaging
1843750000	BLL 5.08/02/90FI 3.2SN OR BX	PCB plug-in connector, female header, 5.08 mm, No. of poles: 2, 90°, Solder pin length: 3.2 mm, tinned, Orange, Solder connection, Box	4032248355501	100 pc(s).	Box

BLF 5.08/90LH SN



Just as reliable as the tried-and-true original, with innovation in detail:

The BLF 5.0x – the PUSH-IN version of the BLZ 5.0x socket block – features a new connection system and a more compact design. Weidmüller's innovative PUSH-IN spring connection features a trend-setting, tool-free wire connection system that is simple to operate.

In terms of versatility, the BLF 5.0x offers just as much as the older versions:

- The choice of three wire outlet directions offers you proven design flexibility for your applications.
- Four flange variations, including the patented release latch, allow for user-friendly unplugging designs.

General ordering data

Order No.	Part designation	Version	GTIN (EAN)	Qty.	Packaging
1002480000	BLF 5.08/02/90LH SN OR BX	PCB plug-in connector, female plug, 5.08 mm, No. of poles: 2, 90°, PUSH IN, Clamping range, max.: 3.31 mm², Box	4032248694853	90 pc(s).	Box
1000640001	BLF 5.08/02/90LH SN BK BX	PCB plug-in connector, female plug, 5.08 mm, No. of poles: 2, 90°, PUSH IN, Clamping range, max.: 3.31 mm², Box	4032248690831	90 pc(s).	Box

System pitch 5.08 mm (0.200 inch) SL-SMT 5.08/02/90G 3.2SN BK BX

Weidmüller Interface GmbH & Co. KG
 Klingenbergstraße 16
 D-32758 Detmold
 Germany
 Fon: +49 5231 14-0
 Fax: +49 5231 14-2083
 www.weidmueller.com

Counterpart

BLZP 5.00/180LR SN



Female connectors with clamping yoke screw connection for conductor connection with straight (180°) outlet direction. The female connectors provide space for labelling and can be coded. Can be fastened with flange or release latch. They feature an integrated plus/minus screw, protection against false insertion under clamping yoke. They are delivered with an opened clamping yoke.

- 0.2-2.5 mm² (IEC) / 26-12 AWG (UL)
- 400 V (IEC) / 300 V (UL)
- 19 A (IEC) / 15 A (UL)

General ordering data

Order No.	Part designation	Version	GTIN (EAN)	Qty.	Packaging
1956370000	BLZP 5.00/02/180LR SN OR BX	PCB plug-in connector, female plug, 5.00 mm, No. of poles: 2, 180°, Clamping yoke connection, Clamping range, max.: 4 mm ² , Box	4032248635078	100 pc(s).	Box
1956600000	BLZP 5.00/02/180LR SN BK BX	PCB plug-in connector, female plug, 5.00 mm, No. of poles: 2, 180°, Clamping yoke connection, Clamping range, max.: 4 mm ² , Box	4032248635436	100 pc(s).	Box

BLDT 5.08B



Female connectors with two clamping yoke screw connections per pole for conductor connection with 90° & 270° outlet direction. The female connectors provide space for labelling and can be coded. Packed in cardboard box.

- 0.20 - 2.5 mm² (IEC) / 26 - 12 AWG (UL)
- 400 V (IEC) / 300 V (UL)
- 14 A (IEC) / 10 A (UL)

General ordering data

Order No.	Part designation	Version	GTIN (EAN)	Qty.	Packaging
1673780000	BLDT 5.08/02/-B SN BK BX	PCB plug-in connector, female plug, 5.08 mm, No. of poles: 2, 90°/270°, Clamping yoke connection, Clamping range, max.: 3.31 mm ² , Box	4008190435509	100 pc(s).	Box
1651740000	BLDT 5.08/02/-B SN OR BX	PCB plug-in connector, female plug, 5.08 mm, No. of poles: 2, 90°/270°, Clamping yoke connection, Clamping range, max.: 3.31 mm ² , Box	4008190400422	100 pc(s).	Box