



Chipsmall Limited consists of a professional team with an average of over 10 year of expertise in the distribution of electronic components. Based in Hongkong, we have already established firm and mutual-benefit business relationships with customers from,Europe,America and south Asia,supplying obsolete and hard-to-find components to meet their specific needs.

With the principle of “Quality Parts,Customers Priority,Honest Operation,and Considerate Service”,our business mainly focus on the distribution of electronic components. Line cards we deal with include Microchip,ALPS,ROHM,Xilinx,Pulse,ON,Everlight and Freescale. Main products comprise IC,Modules,Potentiometer,IC Socket,Relay,Connector.Our parts cover such applications as commercial,industrial, and automotives areas.

We are looking forward to setting up business relationship with you and hope to provide you with the best service and solution. Let us make a better world for our industry!



## Contact us

Tel: +86-755-8981 8866 Fax: +86-755-8427 6832

Email & Skype: info@chipsmall.com Web: www.chipsmall.com

Address: A1208, Overseas Decoration Building, #122 Zhenhua RD., Futian, Shenzhen, China



**System pitch 5.08 mm (0.200 inch)  
SL-SMT 5.08/04/90G 3.2SN BK BX**

**Weidmüller Interface GmbH & Co. KG**  
Klingenbergstraße 16  
D-32758 Detmold  
Germany  
Fon: +49 5231 14-0  
Fax: +49 5231 14-2083  
www.weidmueller.com



High-temperature-resistant male connector, packed in box or tape. In tape with 1.5 mm solder pin optimised for automatic assembly. 3.2 mm solder pin suitable for reflow and wave soldering. These male connectors can be labelled and coded.

- 400 V (IEC) / 300 V (UL)
- 19 A (IEC) / 15 A (UL)

**General ordering data**

Order No.	<a href="#">1780200000</a>
Part designation	SL-SMT 5.08/04/90G 3.2SN BK BX
Version	PCB plug-in connector, male header, 5.08 mm, No. of poles: 4, 90°, Solder pin length: 3.2 mm, tinned, black, Reflow solder connection, Box
GTIN (EAN)	4032248165520
Qty.	100 pc(s).
Packaging	Box

## System pitch 5.08 mm (0.200 inch) SL-SMT 5.08/04/90G 3.2SN BK BX

**Weidmüller Interface GmbH & Co. KG**  
Klingenbergstraße 16  
D-32758 Detmold  
Germany  
Fon: +49 5231 14-0  
Fax: +49 5231 14-2083  
www.weidmueller.com

## Technical data

### System parameters

Fitted to PCB	Reflow solder connection	Outgoing elbow	90°
Pitch in mm	5.08 mm	Pitch in inch	0.2 inch
No. of poles	4	Solder pin length	3.2 mm
Can be coded	Yes	No. of rows	1
Number of solder pins per pole	1	L1 in mm	15.24 mm
L1 in inch	0.6 inch		

### Material data

Insulating material	LCP GF	Colour	black
Insulating material group	IIIa	Flammability class UL 94	V-0
Contact material	CuSn	Contact surface	tinned
Highest continuous operating temperature, min.	-25 °C	Highest continuous operating temperature, max.	100 °C
Max. relative humidity during storage	80 %		

### DIN IEC rating data

Rated current, min. No. of poles (Tu=20°C)	19 A	Rated current, max. No. of poles (Tu=20°C)	15 A
Rated current, no. of poles (Tu=40°C), min.	16 A	Rated current, no. of poles (Tu=40°C), max.	13 A
Rated voltage at overvoltage category/pollution degree III/3	250 V	Rated impulse withstand voltage for overvoltage class/pollution severity III/3	4 kV
Rated voltage for overvoltage class/pollution severity III/2	320 V	Rated impulse withstand voltage for overvoltage class/pollution severity III/2	4 kV
Rated voltage for overvoltage class/pollution severity II/2	400 V	Rated impulse withstand voltage for overvoltage class/pollution severity II/2	4 kV

### CSA rating data

Rated voltage (Use group B)	300 V	Rated current (use group B)	15 A
Rated voltage (use group D)	300 V	Rated current (use group D)	10 A

### UL 1059 rating data

Rated voltage (use group B)	300 V	Rated current (use group B)	15 A
Rated voltage (use group D)	300 V	Rated current (use group D)	10 A

### Approvals

Approvals institutes	CSA; GOSTME25; UR; ROHS
----------------------	-------------------------

### Classifications

ETIM 3.0	EC001284	eClass 5.1	27-26-07-04
eClass 6.0	27-26-07-04		

**Datasheet**

**System pitch 5.08 mm (0.200 inch)**  
**SL-SMT 5.08/04/90G 3.2SN BK BX**

**Weidmüller Interface GmbH & Co. KG**  
Klingenbergstraße 16  
D-32758 Detmold  
Germany  
Fon: +49 5231 14-0  
Fax: +49 5231 14-2083  
[www.weidmueller.com](http://www.weidmueller.com)

**Technical data****Notes**

Notes

- Additional colours on request
- Gold-plated contact surfaces on request
- Rated current related to rated cross-section and min. No. of poles.
- Diameter of solder eyelet  $D = 1.4 \pm 0.1$  mm
- Diameter of solder eyelet  $D = 1.5 \pm 0.1$  mm from 9-pole
- P on drg. = pitch
- Rated data refer only to the component itself. Clearance and creepage distances to other components are to be designed in accordance with the relevant application standards.

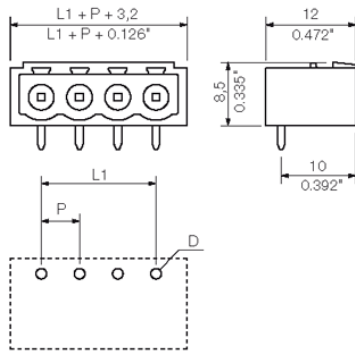
**Datasheet****System pitch 5.08 mm (0.200 inch)  
SL-SMT 5.08/04/90G 3.2SN BK BX****Weidmüller Interface GmbH & Co. KG**  
Klingenbergstraße 16  
D-32758 Detmold  
Germany  
Fon: +49 5231 14-0  
Fax: +49 5231 14-2083  
[www.weidmueller.com](http://www.weidmueller.com)**Drawings**



## System pitch 5.08 mm (0.200 inch) SL-SMT 5.08/04/90G 3.2SN BK BX

**Weidmüller Interface GmbH & Co. KG**  
Klingenbergstraße 16  
D-32758 Detmold  
Germany  
Fon: +49 5231 14-0  
Fax: +49 5231 14-2083  
www.weidmueller.com

## Counterpart

### BLZ 5.08F QV2



Female connectors with clamping yoke screw connection for conductor connection with straight outlet direction and internal cross-connection for connections 1-2 & 3-4. Bus current up to 32 A for 4 mm<sup>2</sup> (without wire end ferrules). The female connectors provide space for labelling and can be coded. Packed in cardboard box.

- 0.20 - 2.5 mm<sup>2</sup> (IEC) / 26 - 14 AWG (UL)
- 400 V (IEC) / 300 V (UL)
- 17.5 A (IEC) / 10 A (UL)

### General ordering data

Order No.	Part designation	Version	GTIN (EAN)	Qty.	Packaging
<a href="#">1844500000</a>	BLZ 5.08/04/180FQV2 SN BK BX	PCB plug-in connector, female plug, 5.08 mm, No. of poles: 4, 180°, Clamping yoke connection, Clamping range, max.: 4 mm <sup>2</sup> , Box	4032248354948	100 pc(s).	Box
<a href="#">1846870000</a>	BLZ 5.08/04/180FQV2 SN OR BX	PCB plug-in connector, female plug, 5.08 mm, No. of poles: 4, 180°, Clamping yoke connection, Clamping range, max.: 4 mm <sup>2</sup> , Box	4032248362684	100 pc(s).	Box

### BLZP 5.08/225 SN



Clamping-yoke wire connection with right-angled (90° or 270°) or angled (225°) outlet direction. The female connectors provide space for labelling and can be coded. Can be fastened with flange or release latch. They feature an integrated plus/minus screw, protection against false insertion under clamping yoke. They are delivered with an opened clamping yoke.

- 0.2-2.5 mm<sup>2</sup> (IEC) / 26-12 AWG (UL)
- 400 V (IEC) / 300 V (UL)
- 17.5 A (IEC) / 10 A (UL)

### General ordering data

Order No.	Part designation	Version	GTIN (EAN)	Qty.	Packaging
<a href="#">1946270000</a>	BLZP 5.08/04/225 SN OR BX	PCB plug-in connector, female plug, 5.08 mm, No. of poles: 4, 225°, Clamping yoke connection, Clamping range, max.: 4 mm <sup>2</sup> , Box	4032248621842	90 pc(s).	Box
<a href="#">1946580000</a>	BLZP 5.08/04/225 SN BK BX	PCB plug-in connector, female plug, 5.08 mm, No. of poles: 4, 225°, Clamping yoke connection, Clamping range, max.: 4 mm <sup>2</sup> , Box	4032248622351	90 pc(s).	Box

## System pitch 5.08 mm (0.200 inch) SL-SMT 5.08/04/90G 3.2SN BK BX

**Weidmüller Interface GmbH & Co. KG**  
 Klingenbergstraße 16  
 D-32758 Detmold  
 Germany  
 Fon: +49 5231 14-0  
 Fax: +49 5231 14-2083  
 www.weidmueller.com

## Counterpart

### BLZP 5.08/180 SN



Female connectors with clamping yoke screw connection for conductor connection with straight (180°) outlet direction. The female connectors provide space for labelling and can be coded. Can be fastened with flange or release latch. They feature an integrated plus/minus screw, protection against false insertion under clamping yoke. They are delivered with an opened clamping yoke.

- 0.2-2.5 mm<sup>2</sup> (IEC) / 26-12 AWG (UL)
- 400 V (IEC) / 300 V (UL)
- 19 A (IEC) / 15 A (UL)

#### General ordering data

Order No.	Part designation	Version	GTIN (EAN)	Qty.	Packaging
<a href="#">1943600000</a>	BLZP 5.08/04/180 SN OR BX	PCB plug-in connector, female plug, 5.08 mm, No. of poles: 4, 180°, Clamping yoke connection, Clamping range, max.: 4 mm <sup>2</sup> , Box	4032248617593	100 pc(s).	Box
<a href="#">1943830000</a>	BLZP 5.08/04/180 SN BK BX	PCB plug-in connector, female plug, 5.08 mm, No. of poles: 4, 180°, Clamping yoke connection, Clamping range, max.: 4 mm <sup>2</sup> , Box	4032248617869	100 pc(s).	Box

### BLF 5.08/90 SN



Just as reliable as the tried-and-true original, with innovation in detail:

The BLF 5.0x – the PUSH-IN version of the BLZ 5.0x socket block – features a new connection system and a more compact design. Weidmüller's innovative PUSH-IN spring connection features a trend-setting, tool-free wire connection system that is simple to operate.

In terms of versatility, the BLF 5.0x offers just as much as the older versions:

- The choice of three wire outlet directions offers you proven design flexibility for your applications.
- Four flange variations, including the patented release latch, allow for user-friendly unplugging designs.

#### General ordering data

Order No.	Part designation	Version	GTIN (EAN)	Qty.	Packaging
<a href="#">1001550000</a>	BLF 5.08/04/90 SN OR BX	PCB plug-in connector, female plug, 5.08 mm, No. of poles: 4, 90°, PUSH IN, Clamping range, max.: 3.31 mm <sup>2</sup> , Box	4032248693351	90 pc(s).	Box
<a href="#">1000050001</a>	BLF 5.08/04/90 SN BK BX	PCB plug-in connector, female plug, 5.08 mm, No. of poles: 4, 90°, PUSH IN, Clamping range, max.: 3.31 mm <sup>2</sup> , Box	4032248689989	90 pc(s).	Box

## System pitch 5.08 mm (0.200 inch) SL-SMT 5.08/04/90G 3.2SN BK BX

**Weidmüller Interface GmbH & Co. KG**  
 Klingenbergstraße 16  
 D-32758 Detmold  
 Germany  
 Fon: +49 5231 14-0  
 Fax: +49 5231 14-2083  
 www.weidmueller.com

## Counterpart

### BLZP 5.00/270 SN

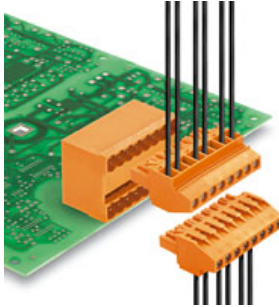

Socket connectors with clamping yoke screw connection for conductor connection with a right-angle (90° or 270°) outlet direction. The female connectors provide space for labelling and can be coded. Can be fastened with flange or release latch. They feature an integrated plus/minus screw, protection against false insertion under clamping yoke. They are delivered with an opened clamping yoke.

- 0.2-2.5 mm<sup>2</sup> (IEC) / 26-12 AWG (UL)
- 400 V (IEC) / 300 V (UL)
- 15 A (IEC) / 10 A (UL)

#### General ordering data

Order No.	Part designation	Version	GTIN (EAN)	Qty.	Packaging
<a href="#">1959080000</a>	BLZP 5.00/04/270 SN BK BX	PCB plug-in connector, female plug, 5.00 mm, No. of poles: 4, 90°, Clamping yoke connection, Clamping range, max.: 4 mm <sup>2</sup> , Box	4032248638017	90 pc(s).	Box
<a href="#">1958850000</a>	BLZP 5.00/04/270 SN OR BX	PCB plug-in connector, female plug, 5.00 mm, No. of poles: 4, 90°, Clamping yoke connection, Clamping range, max.: 4 mm <sup>2</sup> , Box	4032248637683	90 pc(s).	Box

### BLZ 5.00/270



Female connectors with clamping yoke screw connection. The female connectors provide space for labelling and can be coded. Packed in cardboard box.

- 0.20 - 2.5 mm<sup>2</sup> (IEC) / 26 - 12 AWG (UL)
- 400 V (IEC) / 300 V (UL)
- 15 A (IEC) / 10 A (UL)

#### General ordering data

Order No.	Part designation	Version	GTIN (EAN)	Qty.	Packaging
<a href="#">1637830000</a>	BLZ 5.00/04/270 SN BK BX	PCB plug-in connector, female plug, 5.00 mm, No. of poles: 4, 270°, Clamping yoke connection, Clamping range, max.: 3.31 mm <sup>2</sup> , Box	4008190275075	90 pc(s).	Box
<a href="#">1637600000</a>	BLZ 5.00/04/270 SN OR BX	PCB plug-in connector, female plug, 5.00 mm, No. of poles: 4, 270°, Clamping yoke connection, Clamping range, max.: 3.31 mm <sup>2</sup> , Box	4008190274849	90 pc(s).	Box



## System pitch 5.08 mm (0.200 inch) SL-SMT 5.08/04/90G 3.2SN BK BX

**Weidmüller Interface GmbH & Co. KG**  
 Klingenbergstraße 16  
 D-32758 Detmold  
 Germany  
 Fon: +49 5231 14-0  
 Fax: +49 5231 14-2083  
 www.weidmueller.com

## Counterpart

### BLL 5.08/180



Female connector for PCB mounting. The solder pin length is optimised for wave flow soldering. Packed in cardboard box.

- 400 V (IEC) / 300 V (UL)
- 23 A (IEC) / 15 A (UL)

#### General ordering data

Order No.	Part designation	Version	GTIN (EAN)	Qty.	Packaging
<a href="#">1630730000</a>	BLL 5.08/04/180 3.2SN OR BX	PCB plug-in connector, female header, 5.08 mm, No. of poles: 4, 180°, Solder pin length: 3.2 mm, tinned, Orange, Solder connection, Box	4008190204150	100 pc(s).	Box

### BLZF 5.08/180



Female connectors for connecting conductors with tension clamp system, straight 180° outlet direction. The female connectors include space for labelling and can be coded. Packed in cardboard box.

- 0.20 - 2.5 mm<sup>2</sup> (IEC) / 26 - 12 AWG (UL)
- 400 V (IEC) / 300 V (UL)
- 17 A (IEC) / 15 A (UL)

#### General ordering data

Order No.	Part designation	Version	GTIN (EAN)	Qty.	Packaging
<a href="#">1707480000</a>	BLZF 5.08/04/180 SN OR BX	PCB plug-in connector, female plug, 5.08 mm, No. of poles: 4, 180°, Tension clamp connection, Clamping range, max.: 3.31 mm <sup>2</sup> , Box	4008190395858	90 pc(s).	Box
<a href="#">1707710000</a>	BLZF 5.08/04/180 SN BK BX	PCB plug-in connector, female plug, 5.08 mm, No. of poles: 4, 180°, Tension clamp connection, Clamping range, max.: 3.31 mm <sup>2</sup> , Box	4008190316716	90 pc(s).	Box

## System pitch 5.08 mm (0.200 inch) SL-SMT 5.08/04/90G 3.2SN BK BX

**Weidmüller Interface GmbH & Co. KG**  
 Klingenbergstraße 16  
 D-32758 Detmold  
 Germany  
 Fon: +49 5231 14-0  
 Fax: +49 5231 14-2083  
 www.weidmueller.com

## Counterpart

### BLF 5.00/90 SN



Just as reliable as the tried-and-true original, with innovation in detail:

The BLF 5.0x – the PUSH-IN version of the BLZ 5.0x socket block – features a new connection system and a more compact design. Weidmüller's innovative PUSH-IN spring connection features a trend-setting, tool-free wire connection system that is simple to operate.

In terms of versatility, the BLF 5.0x offers just as much as the older versions:

- The choice of three wire outlet directions offers you proven design flexibility for your applications.
- Four flange variations, including the patented release latch, allow for user-friendly unplugging designs.

### General ordering data

Order No.	Part designation	Version	GTIN (EAN)	Qty.	Packaging
<a href="#">1980190000</a>	BLF 5.00/04/90 SN OR BX	PCB plug-in connector, female plug, 5.00 mm, No. of poles: 4, 90°, PUSH IN, Clamping range, max.: 3.31 mm², Box	4032248675272	90 pc(s).	Box
<a href="#">1979290000</a>	BLF 5.00/04/90 SN BK BX	PCB plug-in connector, female plug, 5.00 mm, No. of poles: 4, 90°, PUSH IN, Clamping range, max.: 3.31 mm², Box	4032248674473	90 pc(s).	Box

### BLIDC 5.08



Female connectors for conductor connection with IDC system. The female connectors provide space for labelling and can be coded. Packed in cardboard box.

- 0.35 - 0.75 mm² (IEC) / 22 - 20 AWG (UL)
- 400 V (IEC) / 300 V (UL)
- 11 A (IEC) / 5 A (UL)

### General ordering data

Order No.	Part designation	Version	GTIN (EAN)	Qty.	Packaging
<a href="#">1724960000</a>	BLIDC 5.08/04/180 SN OR BX	PCB plug-in connector, female plug, 5.08 mm, No. of poles: 4, 180°, IDC terminal, Clamping range, max.: 0.75 mm², Box	4008190377304	100 pc(s).	Box

## System pitch 5.08 mm (0.200 inch) SL-SMT 5.08/04/90G 3.2SN BK BX

**Weidmüller Interface GmbH & Co. KG**  
 Klingenbergstraße 16  
 D-32758 Detmold  
 Germany  
 Fon: +49 5231 14-0  
 Fax: +49 5231 14-2083  
 www.weidmueller.com

## Counterpart

### BLZP 5.00/90 SN



Socket connectors with clamping yoke screw connection for conductor connection with a right-angle (90° or 270°) outlet direction. The female connectors provide space for labelling and can be coded. Can be fastened with flange or release latch. They feature an integrated plus/minus screw, protection against false insertion under clamping yoke. They are delivered with an opened clamping yoke.

- 0.2-2.5 mm<sup>2</sup> (IEC) / 26-12 AWG (UL)
- 400 V (IEC) / 300 V (UL)
- 15 A (IEC) / 10 A (UL)

#### General ordering data

Order No.	Part designation	Version	GTIN (EAN)	Qty.	Packaging
<a href="#">1958280000</a>	BLZP 5.00/04/90 SN OR BX	PCB plug-in connector, female plug, 5.00 mm, No. of poles: 4, 90°, Clamping yoke connection, Clamping range, max.: 4 mm <sup>2</sup> , Box	4032248637140	90 pc(s).	Box
<a href="#">1958630000</a>	BLZP 5.00/04/90 SN BK BX	PCB plug-in connector, female plug, 5.00 mm, No. of poles: 4, 90°, Clamping yoke connection, Clamping range, max.: 4 mm <sup>2</sup> , Box	4032248637362	90 pc(s).	Box

### BLZ 5.00/90



Female connectors with clamping yoke screw connection. The female connectors provide space for labelling and can be coded. Packed in cardboard box.

- 0.20 - 2.5 mm<sup>2</sup> (IEC) / 26 - 12 AWG (UL)
- 400 V (IEC) / 300 V (UL)
- 15 A (IEC) / 10 A (UL)

#### General ordering data

Order No.	Part designation	Version	GTIN (EAN)	Qty.	Packaging
<a href="#">1635960000</a>	BLZ 5.00/04/90 SN OR BX	PCB plug-in connector, female plug, 5.00 mm, No. of poles: 4, 90°, Clamping yoke connection, Clamping range, max.: 3.31 mm <sup>2</sup> , Box	4008190265830	90 pc(s).	Box
<a href="#">1636910000</a>	BLZ 5.00/04/90 SN BK BX	PCB plug-in connector, female plug, 5.00 mm, No. of poles: 4, 90°, Clamping yoke connection, Clamping range, max.: 3.31 mm <sup>2</sup> , Box	4008190274153	90 pc(s).	Box

## System pitch 5.08 mm (0.200 inch) SL-SMT 5.08/04/90G 3.2SN BK BX

**Weidmüller Interface GmbH & Co. KG**  
 Klingenbergstraße 16  
 D-32758 Detmold  
 Germany  
 Fon: +49 5231 14-0  
 Fax: +49 5231 14-2083  
 www.weidmueller.com

## Counterpart

### BLZF 5.08/90



Female connectors for connecting conductors with tension clamp system. The female connectors include space for labelling and can be coded. Packed in cardboard box.

- 0.20 - 2.5 mm<sup>2</sup> (IEC) / 26 - 12 AWG (UL)
- 400 V (IEC) / 300 V (UL)
- 16.5 A (IEC) / 10 A (UL)

### General ordering data

Order No.	Part designation	Version	GTIN (EAN)	Qty.	Packaging
<a href="#">1671040000</a>	BLZF 5.08/04/90 SN BK BX	PCB plug-in connector, female plug, 5.08 mm, No. of poles: 4, 90°, Tension clamp connection, Clamping range, max.: 3.31 mm <sup>2</sup> , Box	4008190432713	90 pc(s).	Box
<a href="#">1670810000</a>	BLZF 5.08/04/90 SN OR BX	PCB plug-in connector, female plug, 5.08 mm, No. of poles: 4, 90°, Tension clamp connection, Clamping range, max.: 3.31 mm <sup>2</sup> , Box	4008190432416	90 pc(s).	Box

### BL 5.00



Female connectors for conductor connection in leaf spring system. Packed in cardboard box. The female connectors provide space for labelling. Packed in cardboard box.

- 0.2 - 1.5 mm<sup>2</sup> (IEC) / 26 - 14 AWG (UL)
- 400 V (IEC) / 300 V (UL)
- 11 A (IEC) / 10 A (UL)

### General ordering data

Order No.	Part designation	Version	GTIN (EAN)	Qty.	Packaging
<a href="#">1730720000</a>	BL 5.00/04/180 SN BK BX	PCB plug-in connector, female plug, 5.00 mm, No. of poles: 4, 180°, Leaf spring connection, Clamping range, max.: 2.08 mm <sup>2</sup> , Box	4008190387310	100 pc(s).	Box
<a href="#">1723130000</a>	BL 5.00/04/180 SN OR BX	PCB plug-in connector, female plug, 5.00 mm, No. of poles: 4, 180°, Leaf spring connection, Clamping range, max.: 2.08 mm <sup>2</sup> , Box	4032248002535	100 pc(s).	Box
<a href="#">1762790000</a>	BL 5.00/04/180 SN GY BX	PCB plug-in connector, female plug, 5.00 mm, No. of poles: 4, 180°, Leaf spring connection,	4032248048700	100 pc(s).	Box

## System pitch 5.08 mm (0.200 inch) SL-SMT 5.08/04/90G 3.2SN BK BX

**Weidmüller Interface GmbH & Co. KG**  
Klingenbergstraße 16  
D-32758 Detmold  
Germany  
Fon: +49 5231 14-0  
Fax: +49 5231 14-2083  
www.weidmueller.com

## Counterpart

Clamping range, max.: 2.08  
mm<sup>2</sup>, Box

### BLZP 5.00/180 SN



Female connectors with clamping yoke screw connection for conductor connection with straight (180°) outlet direction. The female connectors provide space for labelling and can be coded. Can be fastened with flange or release latch. They feature an integrated plus/minus screw, protection against false insertion under clamping yoke. They are delivered with an opened clamping yoke.

- 0.2-2.5 mm<sup>2</sup> (IEC) / 26-12 AWG (UL)
- 400 V (IEC) / 300 V (UL)
- 19 A (IEC) / 15 A (UL)

#### General ordering data

Order No.	Part designation	Version	GTIN (EAN)	Qty.	Packaging
<a href="#">1955550000</a>	BLZP 5.00/04/180 SN BK BX	PCB plug-in connector, female plug, 5.00 mm, No. of poles: 4, 180°, Clamping yoke connection, Clamping range, max.: 4 mm <sup>2</sup> , Box	4032248634040	100 pc(s).	Box

### BLIDC 5.08B

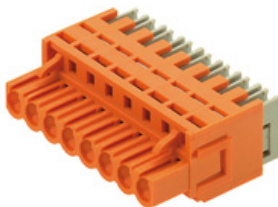

Female connectors for conductor connection with IDC system. The female connectors provide space for labelling and can be coded. Packed in cardboard box.

- 0.35 - 0.75 mm<sup>2</sup> (IEC) / 22 - 20 AWG (UL)
- 400 V (IEC) / 300 V (UL)
- 11 A (IEC) / 5 A (UL)

#### General ordering data

Order No.	Part designation	Version	GTIN (EAN)	Qty.	Packaging
<a href="#">1759630000</a>	BLIDC 5.08/04/180B SN BK BX	PCB plug-in connector, female plug, 5.08 mm, No. of poles: 4, 180°, IDC terminal, Clamping range, max.: 0.75 mm <sup>2</sup> , Box	4032248069866	100 pc(s).	Box



**System pitch 5.08 mm (0.200 inch)  
SL-SMT 5.08/04/90G 3.2SN BK BX**

**Weidmüller Interface GmbH & Co. KG**  
Klingenbergstraße 16  
D-32758 Detmold  
Germany  
Fon: +49 5231 14-0  
Fax: +49 5231 14-2083  
www.weidmueller.com

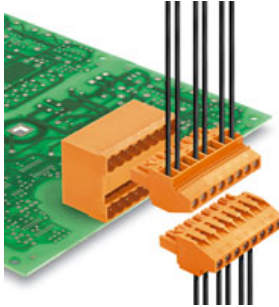
**Counterpart**
**BLZP 5.08/270 SN**

Socket connectors with clamping yoke screw connection for conductor connection with a right-angle (90° or 270°) outlet direction. The female connectors provide space for labelling and can be coded. Can be fastened with flange or release latch. They feature an integrated plus/minus screw, protection against false insertion under clamping yoke. They are delivered with an opened clamping yoke.

- 0.2-2.5 mm<sup>2</sup> (IEC) / 26-12 AWG (UL)
- 400 V (IEC) / 300 V (UL)
- 15 A (IEC) / 10 A (UL)

**General ordering data**

Order No.	Part designation	Version	GTIN (EAN)	Qty.	Packaging
<a href="#">1949040000</a>	BLZP 5.08/04/270 SN BK BX	PCB plug-in connector, female plug, 5.08 mm, No. of poles: 4, 270°, Clamping yoke connection, Clamping range, max.: 4 mm <sup>2</sup> , Box	4032248626496	90 pc(s).	Box
<a href="#">1948810000</a>	BLZP 5.08/04/270 SN OR BX	PCB plug-in connector, female plug, 5.08 mm, No. of poles: 4, 270°, Clamping yoke connection, Clamping range, max.: 4 mm <sup>2</sup> , Box	4032248626267	90 pc(s).	Box

**BLZFS 5.00/180**

Female connectors for connecting conductors with tension clamp system, straight 180° outlet direction in thin-element design. The female connectors include space for labelling and can be coded. Packed in cardboard box.

- 0.20 - 2.5 mm<sup>2</sup> (IEC) / 26 - 14 AWG (UL)
- 400 V (IEC) / 300 V (UL)
- 17 A (IEC) / 10 A (UL)

**General ordering data**

Order No.	Part designation	Version	GTIN (EAN)	Qty.	Packaging
<a href="#">1696620000</a>	BLZFS 5.00/04/180 SN BK BX	PCB plug-in connector, female plug, 5.00 mm, No. of poles: 4, 180°, Tension clamp connection, Clamping range, max.: 2.5 mm <sup>2</sup> , Box	4008190878641	100 pc(s).	Box
<a href="#">1696390000</a>	BLZFS 5.00/04/180 SN OR BX	PCB plug-in connector, female plug, 5.00 mm, No. of poles: 4, 180°, Tension clamp connection, Clamping range, max.: 2.5 mm <sup>2</sup> , Box	4008190878412	100 pc(s).	Box

**System pitch 5.08 mm (0.200 inch)**  
**SL-SMT 5.08/04/90G 3.2SN BK BX**

Weidmüller Interface GmbH & Co. KG  
 Klingenbergstraße 16  
 D-32758 Detmold  
 Germany  
 Fon: +49 5231 14-0  
 Fax: +49 5231 14-2083  
 www.weidmueller.com

Counterpart

**BL 5.08**



Female connectors for conductor connection in leaf spring system. Packed in cardboard box. The female connectors provide space for labelling. Packed in cardboard box.

- 0.2 - 1.5 mm<sup>2</sup> (IEC) / 26 - 14 AWG (UL)
- 400 V (IEC) / 300 V (UL)
- 11 A (IEC) / 10 A (UL)

**General ordering data**

Order No.	Part designation	Version	GTIN (EAN)	Qty.	Packaging
<a href="#">1716490000</a>	BL 5.08/04/180 SN BK BX	PCB plug-in connector, female plug, 5.08 mm, No. of poles: 4, 180°, Leaf spring connection, Clamping range, max.: 2.08 mm <sup>2</sup> , Box	4008190376536	100 pc(s).	Box
<a href="#">1723850000</a>	BL 5.08/04/180 SN DKGX BX	PCB plug-in connector, female plug, 5.08 mm, No. of poles: 4, 180°, Leaf spring connection, Clamping range, max.: 2.08 mm <sup>2</sup> , Box	4008190376215	100 pc(s).	Box
<a href="#">1716340000</a>	BL 5.08/04/180 SN OR BX	PCB plug-in connector, female plug, 5.08 mm, No. of poles: 4, 180°, Leaf spring connection, Clamping range, max.: 2.08 mm <sup>2</sup> , Box	4008190376376	100 pc(s).	Box

**BLZ 5.00/180**



Female connectors with clamping yoke screw connection for conductor connection with straight outlet direction. The female connectors provide space for labelling and can be coded. Packed in cardboard box.

- 0.20 - 2.5 mm<sup>2</sup> (IEC) / 26 - 12 AWG (UL)
- 400 V (IEC) / 300 V (UL)
- 19 A (IEC) / 15 A (UL)

**General ordering data**

Order No.	Part designation	Version	GTIN (EAN)	Qty.	Packaging
<a href="#">1596080000</a>	BLZ 5.00/04/180 SN BK BX	PCB plug-in connector, female plug, 5.00 mm, No. of poles: 4, 180°, Clamping yoke connection, Clamping range, max.: 3.31 mm <sup>2</sup> , Box	4008190176716	100 pc(s).	Box
<a href="#">1571370000</a>	BLZ 5.00/04/180 SN OR BX	PCB plug-in connector, female plug, 5.00 mm, No. of poles: 4, 180°, Clamping yoke connection, Clamping range, max.: 3.31 mm <sup>2</sup> , Box	4008190050641	100 pc(s).	Box

## System pitch 5.08 mm (0.200 inch) SL-SMT 5.08/04/90G 3.2SN BK BX

**Weidmüller Interface GmbH & Co. KG**  
 Klingenbergstraße 16  
 D-32758 Detmold  
 Germany  
 Fon: +49 5231 14-0  
 Fax: +49 5231 14-2083  
 www.weidmueller.com

## Counterpart

connection, Clamping range,  
 max.: 3.31 mm<sup>2</sup>, Box

### BLT 5.08

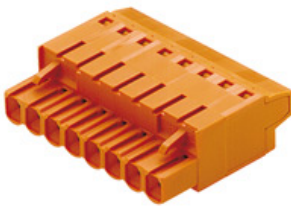

Female connectors with TOP screw system for connecting conductors with straight 180° outlet direction. The female connectors include space for labelling and can be coded. Packed in cardboard box.

- 0.20 - 2.5 mm<sup>2</sup> (IEC) / 26 - 14 AWG (UL)
- 400 V (IEC) / 300 V (UL)
- 17 A (IEC) / 10 A (UL)

### General ordering data

Order No.	Part designation	Version	GTIN (EAN)	Qty.	Packaging
<a href="#">1499760000</a>	BLT 5.08/04/180 SN OR BX	PCB plug-in connector, female plug, 5.08 mm, No. of poles: 4, 180°, TOP connection, Clamping range, max.: 2.5 mm <sup>2</sup> , Box	4008190037536	90 pc(s).	Box
<a href="#">1499710000</a>	BLT 5.08/04/180 SN BK BX	PCB plug-in connector, female plug, 5.08 mm, No. of poles: 4, 180°, TOP connection, Clamping range, max.: 2.5 mm <sup>2</sup> , Box	4008190861711	90 pc(s).	Box

### BLC 5.08R

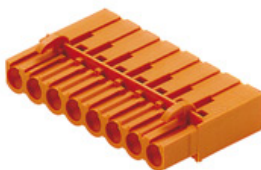

Female connectors for conductor connection with crimp connection system. The female connectors provide space for labelling and can be coded. Packed in cardboard box.

- 0.25 - 2.5 mm<sup>2</sup> (IEC) / 26 - 14 AWG (UL)
- 400 V (IEC) / 300 V (UL)
- 21 A (IEC) / 10 A (UL)

### General ordering data

Order No.	Part designation	Version	GTIN (EAN)	Qty.	Packaging
<a href="#">1610510000</a>	BLC 5.08/04/180R OR BX	PCB plug-in connector, female plug, 5.08 mm, No. of poles: 4, 180°, Crimp connection, Clamping range, max.: 2.5 mm <sup>2</sup> , Box	4008190065102	100 pc(s).	Box
<a href="#">1711980000</a>	BLC 5.08/04/180R BK BX	PCB plug-in connector, female plug, 5.08 mm, No. of poles: 4, 180°, Crimp connection,	4008190934996	100 pc(s).	Box

## System pitch 5.08 mm (0.200 inch) SL-SMT 5.08/04/90G 3.2SN BK BX

**Weidmüller Interface GmbH & Co. KG**  
 Klingenbergstraße 16  
 D-32758 Detmold  
 Germany  
 Fon: +49 5231 14-0  
 Fax: +49 5231 14-2083  
 www.weidmueller.com

## Counterpart

Clamping range, max.: 2.5  
mm², Box

### BLZ 5.08/180



Female connectors with clamping yoke screw connection for conductor connection with straight outlet direction. The female connectors provide space for labelling and can be coded. Packed in cardboard box.

- 0.20 - 2.5 mm² (IEC) / 26 - 12 AWG (UL)
- 400 V (IEC) / 300 V (UL)
- 19 A (IEC) / 15 A (UL)

### General ordering data

Order No.	Part designation	Version	GTIN (EAN)	Qty.	Packaging
<a href="#">1526610000</a>	BLZ 5.08/04/180 SN BK BX	PCB plug-in connector, female plug, 5.08 mm, No. of poles: 4, 180°, Clamping yoke connection, Clamping range, max.: 3.31 mm², Box	4008190049454	100 pc(s).	Box
<a href="#">1526660000</a>	BLZ 5.08/04/180 SN OR BX	PCB plug-in connector, female plug, 5.08 mm, No. of poles: 4, 180°, Clamping yoke connection, Clamping range, max.: 3.31 mm², Box	4008190148232	100 pc(s).	Box

### BLDT 5.08



Female connectors with two clamping yoke screw connections per pole for conductor connection with 90° & 270° outlet direction. The female connectors provide space for labelling and can be coded. Packed in cardboard box.

- 0.20 - 2.5 mm² (IEC) / 26 - 12 AWG (UL)
- 400 V (IEC) / 300 V (UL)
- 14 A (IEC) / 10 A (UL)

### General ordering data

Order No.	Part designation	Version	GTIN (EAN)	Qty.	Packaging
<a href="#">1644750000</a>	BLDT 5.08/04/- SN OR BX	PCB plug-in connector, female plug, 5.08 mm, No. of poles: 4, 90°/270°, Clamping yoke connection, Clamping range, max.: 3.31 mm², Box	4008190283964	50 pc(s).	Box
<a href="#">1660730000</a>	BLDT 5.08/04/- SN BK BX	PCB plug-in connector, female plug, 5.08 mm, No. of poles: 4, 90°/270°, Clamping yoke connection, Clamping range, max.: 3.31 mm², Box	4008190417185	50 pc(s).	Box

## System pitch 5.08 mm (0.200 inch) SL-SMT 5.08/04/90G 3.2SN BK BX

**Weidmüller Interface GmbH & Co. KG**  
 Klingenbergstraße 16  
 D-32758 Detmold  
 Germany  
 Fon: +49 5231 14-0  
 Fax: +49 5231 14-2083  
 www.weidmueller.com

## Counterpart

connection, Clamping range,  
 max.: 3.31 mm<sup>2</sup>, Box

### BLZ 5.08/90

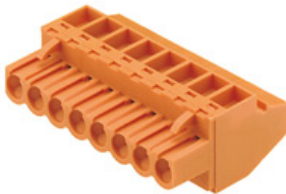

Female connectors with clamping yoke screw connection. The female connectors provide space for labelling and can be coded. Packed in cardboard box.

- 0.20 - 2.5 mm<sup>2</sup> (IEC) / 26 - 12 AWG (UL)
- 400 V (IEC) / 300 V (UL)
- 15 A (IEC) / 10 A (UL)

#### General ordering data

Order No.	Part designation	Version	GTIN (EAN)	Qty.	Packaging
<a href="#">1552910000</a>	BLZ 5.08/04/90 SN BK BX	PCB plug-in connector, female plug, 5.08 mm, No. of poles: 4, 90°, Clamping yoke connection, Clamping range, max.: 3.31 mm <sup>2</sup> , Box	4008190267728	90 pc(s).	Box
<a href="#">1552960000</a>	BLZ 5.08/04/90 SN OR BX	PCB plug-in connector, female plug, 5.08 mm, No. of poles: 4, 90°, Clamping yoke connection, Clamping range, max.: 3.31 mm <sup>2</sup> , Box	4008190123932	90 pc(s).	Box

### BLZ 5.08 QV2

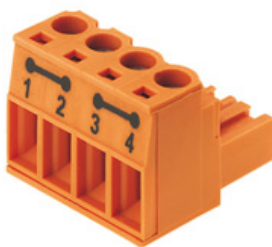

Female connectors with clamping yoke screw connection for conductor connection with straight outlet direction and internal cross-connection for connections 1-2 & 3-4. Bus current up to 32 A for 4 mm<sup>2</sup> (without wire end ferrules). The female connectors provide space for labelling and can be coded. Packed in cardboard box.

- 0.20 - 2.5 mm<sup>2</sup> (IEC) / 26 - 14 AWG (UL)
- 400 V (IEC) / 300 V (UL)
- 17.5 A (IEC) / 10 A (UL)

#### General ordering data

Order No.	Part designation	Version	GTIN (EAN)	Qty.	Packaging
<a href="#">1839770000</a>	BLZ 5.08/04/180QV2 SN OR BX	PCB plug-in connector, female plug, 5.08 mm, No. of poles: 4, 180°, Clamping yoke connection, Clamping range, max.: 4 mm <sup>2</sup> , Box	4032248350292	100 pc(s).	Box
<a href="#">1839780000</a>	BLZ 5.08/04/180QV2 SN BK BX	PCB plug-in connector, female plug, 5.08 mm, No. of poles: 4, 180°, Clamping yoke connection, Clamping range, max.: 4 mm <sup>2</sup> , Box	4032248350308	100 pc(s).	Box



## System pitch 5.08 mm (0.200 inch) SL-SMT 5.08/04/90G 3.2SN BK BX

**Weidmüller Interface GmbH & Co. KG**  
 Klingenbergstraße 16  
 D-32758 Detmold  
 Germany  
 Fon: +49 5231 14-0  
 Fax: +49 5231 14-2083  
 www.weidmueller.com

## Counterpart

connection, Clamping range,  
 max.: 4 mm<sup>2</sup>, Box

### BLL 5.08/90



Female connector for PCB mounting. The solder pin length is optimised for wave flow soldering. Packed in cardboard box.

- 400 V (IEC) / 300 V (UL)
- 23 A (IEC) / 15 A (UL)

#### General ordering data

Order No.	Part designation	Version	GTIN (EAN)	Qty.	Packaging
<a href="#">1622960000</a>	BLL 5.08/04/90 3.2SN OR BX	PCB plug-in connector, female header, 5.08 mm, No. of poles: 4, 90°, Solder pin length: 3.2 mm, tinned, Orange, Solder connection, Box	4008190194024	100 pc(s).	Box

### BLZ 5.08/225



Female connectors with clamping yoke screw connection for conductor connection with 225° outlet direction. The female connectors provide space for labelling and can be coded. Packed in cardboard box.

- 0.20 - 2.5 mm<sup>2</sup> (IEC) / 26 - 12 AWG (UL)
- 400 V (IEC) / 300 V (UL)
- 16.5 A (IEC) / 10 A (UL)

#### General ordering data

Order No.	Part designation	Version	GTIN (EAN)	Qty.	Packaging
<a href="#">1741890000</a>	BLZ 5.08/04/225 SN BK BX	PCB plug-in connector, female plug, 5.08 mm, No. of poles: 4, 225°, Clamping yoke connection, Clamping range, max.: 3.31 mm <sup>2</sup> , Box	4008190254155	90 pc(s).	Box
<a href="#">1741660000</a>	BLZ 5.08/04/225 SN OR BX	PCB plug-in connector, female plug, 5.08 mm, No. of poles: 4, 225°, Clamping yoke connection, Clamping range, max.: 3.31 mm <sup>2</sup> , Box	4008190202637	90 pc(s).	Box

## System pitch 5.08 mm (0.200 inch) SL-SMT 5.08/04/90G 3.2SN BK BX

**Weidmüller Interface GmbH & Co. KG**  
 Klingenbergstraße 16  
 D-32758 Detmold  
 Germany  
 Fon: +49 5231 14-0  
 Fax: +49 5231 14-2083  
 www.weidmueller.com

## Counterpart

### BLZ 5.08/270



Female connectors with clamping yoke screw connection. The female connectors provide space for labelling and can be coded. Packed in cardboard box.

- 0.20 - 2.5 mm<sup>2</sup> (IEC) / 26 - 12 AWG (UL)
- 400 V (IEC) / 300 V (UL)
- 15 A (IEC) / 10 A (UL)

### General ordering data

Order No.	Part designation	Version	GTIN (EAN)	Qty.	Packaging
<a href="#">1557510000</a>	BLZ 5.08/04/270 SN BK BX	PCB plug-in connector, female plug, 5.08 mm, No. of poles: 4, 270°, Clamping yoke connection, Clamping range, max.: 3.31 mm <sup>2</sup> , Box	4008190269449	90 pc(s).	Box
<a href="#">1557560000</a>	BLZ 5.08/04/270 SN OR BX	PCB plug-in connector, female plug, 5.08 mm, No. of poles: 4, 270°, Clamping yoke connection, Clamping range, max.: 3.31 mm <sup>2</sup> , Box	4008190104788	90 pc(s).	Box

### BLZF 5.08/270



Female connectors for connecting conductors with tension clamp system. The female connectors include space for labelling and can be coded. Packed in cardboard box.

- 0.20 - 2.5 mm<sup>2</sup> (IEC) / 26 - 12 AWG (UL)
- 400 V (IEC) / 300 V (UL)
- 16.5 A (IEC) / 10 A (UL)

### General ordering data

Order No.	Part designation	Version	GTIN (EAN)	Qty.	Packaging
<a href="#">1671960000</a>	BLZF 5.08/04/270 SN OR BX	PCB plug-in connector, female plug, 5.08 mm, No. of poles: 4, 270°, Tension clamp connection, Clamping range, max.: 3.31 mm <sup>2</sup> , Box	4008190433673	90 pc(s).	Box
<a href="#">1672190000</a>	BLZF 5.08/04/270 SN BK BX	PCB plug-in connector, female plug, 5.08 mm, No. of poles: 4, 270°, Tension clamp connection, Clamping range, max.: 3.31 mm <sup>2</sup> , Box	4008190433901	90 pc(s).	Box

## System pitch 5.08 mm (0.200 inch) SL-SMT 5.08/04/90G 3.2SN BK BX

**Weidmüller Interface GmbH & Co. KG**  
 Klingenbergstraße 16  
 D-32758 Detmold  
 Germany  
 Fon: +49 5231 14-0  
 Fax: +49 5231 14-2083  
 www.weidmueller.com

## Counterpart

### BLZP 5.08/270F SN



Socket connectors with clamping yoke screw connection for conductor connection with a right-angle (90° or 270°) outlet direction. The female connectors provide space for labelling and can be coded. Can be fastened with flange or release latch. They feature an integrated plus/minus screw, protection against false insertion under clamping yoke. They are delivered with an opened clamping yoke.

- 0.2-2.5 mm<sup>2</sup> (IEC) / 26-12 AWG (UL)
- 400 V (IEC) / 300 V (UL)
- 15 A (IEC) / 10 A (UL)

#### General ordering data

Order No.	Part designation	Version	GTIN (EAN)	Qty.	Packaging
<a href="#">1950570000</a>	BLZP 5.08/04/270F SN BK BX	PCB plug-in connector, female plug, 5.08 mm, No. of poles: 4, 270°, Clamping yoke connection, Clamping range, max.: 4 mm <sup>2</sup> , Box	4032248628704	60 pc(s).	Box
<a href="#">1950330000</a>	BLZP 5.08/04/270F SN OR BX	PCB plug-in connector, female plug, 5.08 mm, No. of poles: 4, 270°, Clamping yoke connection, Clamping range, max.: 4 mm <sup>2</sup> , Box	4032248628445	60 pc(s).	Box

### BLZP 5.08/180F SN



Female connectors with clamping yoke screw connection for conductor connection with straight (180°) outlet direction. The female connectors provide space for labelling and can be coded. Can be fastened with flange or release latch. They feature an integrated plus/minus screw, protection against false insertion under clamping yoke. They are delivered with an opened clamping yoke.

- 0.2-2.5 mm<sup>2</sup> (IEC) / 26-12 AWG (UL)
- 400 V (IEC) / 300 V (UL)
- 19 A (IEC) / 15 A (UL)

#### General ordering data

Order No.	Part designation	Version	GTIN (EAN)	Qty.	Packaging
<a href="#">1944350000</a>	BLZP 5.08/04/180F SN BK BX	PCB plug-in connector, female plug, 5.08 mm, No. of poles: 4, 180°, Clamping yoke connection, Clamping range, max.: 4 mm <sup>2</sup> , Box	4032248618927	100 pc(s).	Box
<a href="#">1944110000</a>	BLZP 5.08/04/180F SN OR BX	PCB plug-in connector, female plug, 5.08 mm, No. of poles: 4, 180°, Clamping yoke connection, Clamping range, max.: 4 mm <sup>2</sup> , Box	4032248617494	100 pc(s).	Box

## System pitch 5.08 mm (0.200 inch) SL-SMT 5.08/04/90G 3.2SN BK BX

**Weidmüller Interface GmbH & Co. KG**  
 Klingenbergstraße 16  
 D-32758 Detmold  
 Germany  
 Fon: +49 5231 14-0  
 Fax: +49 5231 14-2083  
 www.weidmueller.com

## Counterpart

### BLZP 5.00/270F SN

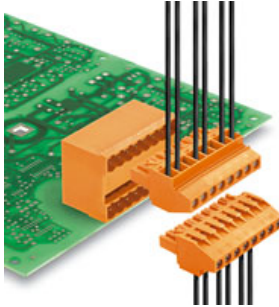

Socket connectors with clamping yoke screw connection for conductor connection with a right-angle (90° or 270°) outlet direction. The female connectors provide space for labelling and can be coded. Can be fastened with flange or release latch. They feature an integrated plus/minus screw, protection against false insertion under clamping yoke. They are delivered with an opened clamping yoke.

- 0.2-2.5 mm<sup>2</sup> (IEC) / 26-12 AWG (UL)
- 400 V (IEC) / 300 V (UL)
- 15 A (IEC) / 10 A (UL)

#### General ordering data

Order No.	Part designation	Version	GTIN (EAN)	Qty.	Packaging
<a href="#">1960710000</a>	BLZP 5.00/04/270F SN BK BX	PCB plug-in connector, female plug, 5.00 mm, No. of poles: 4, 90°, Clamping yoke connection, Clamping range, max.: 4 mm <sup>2</sup> , Box	4032248639502	60 pc(s).	Box
<a href="#">1960440000</a>	BLZP 5.00/04/270F SN OR BX	PCB plug-in connector, female plug, 5.00 mm, No. of poles: 4, 90°, Clamping yoke connection, Clamping range, max.: 4 mm <sup>2</sup> , Box	4032248639304	60 pc(s).	Box

### BLZ 5.00/90B

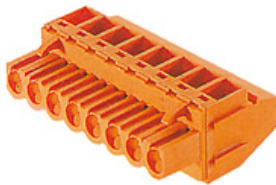

Female connectors with clamping yoke screw connection. The female connectors provide space for labelling and can be coded. Packed in cardboard box.

- 0.20 - 2.5 mm<sup>2</sup> (IEC) / 26 - 12 AWG (UL)
- 400 V (IEC) / 300 V (UL)
- 15 A (IEC) / 10 A (UL)

#### General ordering data

Order No.	Part designation	Version	GTIN (EAN)	Qty.	Packaging
<a href="#">1637140000</a>	BLZ 5.00/04/90B SN OR BX	PCB plug-in connector, female plug, 5.00 mm, No. of poles: 4, 90°, Clamping yoke connection, Clamping range, max.: 3.31 mm <sup>2</sup> , Box	4008190274382	78 pc(s).	Box
<a href="#">1637370000</a>	BLZ 5.00/04/90B SN BK BX	PCB plug-in connector, female plug, 5.00 mm, No. of poles: 4, 90°, Clamping yoke connection, Clamping range, max.: 3.31 mm <sup>2</sup> , Box	4008190274610	78 pc(s).	Box

## System pitch 5.08 mm (0.200 inch) SL-SMT 5.08/04/90G 3.2SN BK BX

**Weidmüller Interface GmbH & Co. KG**  
Klingenbergstraße 16  
D-32758 Detmold  
Germany  
Fon: +49 5231 14-0  
Fax: +49 5231 14-2083  
www.weidmueller.com

## Counterpart

### BLZ 5.08/180LH



Socket connectors with clamping yoke screw connection for conductor connection with 270° outlet direction and release lever or release latch mechanism. The female connectors provide space for labelling and can be coded. Packed in cardboard box.br/>

- 0.20–1.5 mm<sup>2</sup> (IEC) / 26–12 AWG (UL)
- 400 V (IEC) / 300 V (UL)
- 19 A (IEC) / 15 A (UL)

### General ordering data

Order No.	Part designation	Version	GTIN (EAN)	Qty.	Packaging
<a href="#">1893620000</a>	BLZ 5.08/04/180LH SN BK BX	PCB plug-in connector, female plug, 5.08 mm, No. of poles: 4, 180°, Clamping yoke connection, Clamping range, max.: 3.31 mm <sup>2</sup> , Box	4032248507801	100 pc(s).	Box
<a href="#">1892210000</a>	BLZ 5.08/04/180LH SN OR BX	PCB plug-in connector, female plug, 5.08 mm, No. of poles: 4, 180°, Clamping yoke connection, Clamping range, max.: 3.31 mm <sup>2</sup> , Box	4032248505531	100 pc(s).	Box

### BLZP 5.08/90F SN

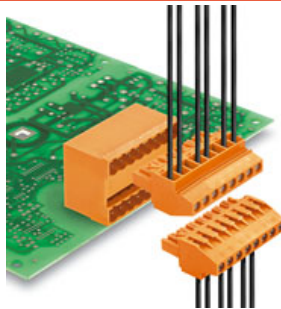

Socket connectors with clamping yoke screw connection for conductor connection with a right-angle (90° or 270°) outlet direction. The female connectors provide space for labelling and can be coded. Can be fastened with flange or release latch. They feature an integrated plus/minus screw, protection against false insertion under clamping yoke. They are delivered with an opened clamping yoke.

- 0.2-2.5 mm<sup>2</sup> (IEC) / 26-12 AWG (UL)
- 400 V (IEC) / 300 V (UL)
- 15 A (IEC) / 10 A (UL)

### General ordering data

Order No.	Part designation	Version	GTIN (EAN)	Qty.	Packaging
<a href="#">1950060000</a>	BLZP 5.08/04/90F SN BK BX	PCB plug-in connector, female plug, 5.08 mm, No. of poles: 4, 90°, Clamping yoke connection, Clamping range, max.: 4 mm <sup>2</sup> , Box	4032248627998	60 pc(s).	Box
<a href="#">1949820000</a>	BLZP 5.08/04/90F SN OR BX	PCB plug-in connector, female plug, 5.08 mm, No. of poles: 4, 90°, Clamping yoke connection, Clamping range, max.: 4 mm <sup>2</sup> , Box	4032248627745	60 pc(s).	Box



**System pitch 5.08 mm (0.200 inch)  
SL-SMT 5.08/04/90G 3.2SN BK BX**

**Weidmüller Interface GmbH & Co. KG**  
Klingenbergstraße 16  
D-32758 Detmold  
Germany  
Fon: +49 5231 14-0  
Fax: +49 5231 14-2083  
www.weidmueller.com

**Counterpart**
**BLZP 5.00/180F SN**

Female connectors with clamping yoke screw connection for conductor connection with straight (180°) outlet direction. The female connectors provide space for labelling and can be coded. Can be fastened with flange or release latch. They feature an integrated plus/minus screw, protection against false insertion under clamping yoke. They are delivered with an opened clamping yoke.

- 0.2-2.5 mm<sup>2</sup> (IEC) / 26-12 AWG (UL)
- 400 V (IEC) / 300 V (UL)
- 19 A (IEC) / 15 A (UL)

**General ordering data**

Order No.	Part designation	Version	GTIN (EAN)	Qty.	Packaging
<a href="#">1956010000</a>	BLZP 5.00/04/180F SN BK BX	PCB plug-in connector, female plug, 5.00 mm, No. of poles: 4, 180°, Clamping yoke connection, Clamping range, max.: 4 mm <sup>2</sup> , Box	4032248634583	100 pc(s).	Box
<a href="#">1955780000</a>	BLZP 5.00/04/180F SN OR BX	PCB plug-in connector, female plug, 5.00 mm, No. of poles: 4, 180°, Clamping yoke connection, Clamping range, max.: 4 mm <sup>2</sup> , Box	4032248634323	100 pc(s).	Box

**BLZP 5.00/270LH SN**

Socket connectors with clamping yoke screw connection for conductor connection with a right-angle (90° or 270°) outlet direction. The female connectors provide space for labelling and can be coded. Can be fastened with flange or release latch. They feature an integrated plus/minus screw, protection against false insertion under clamping yoke. They are delivered with an opened clamping yoke.

- 0.2-2.5 mm<sup>2</sup> (IEC) / 26-12 AWG (UL)
- 400 V (IEC) / 300 V (UL)
- 15 A (IEC) / 10 A (UL)

**General ordering data**

Order No.	Part designation	Version	GTIN (EAN)	Qty.	Packaging
<a href="#">1961650000</a>	BLZP 5.00/04/270LH SN BK BX	PCB plug-in connector, female plug, 5.00 mm, No. of poles: 4, 90°, Clamping yoke connection, Clamping range, max.: 4 mm <sup>2</sup> , Box	4032248640928	60 pc(s).	Box
<a href="#">1961420000</a>	BLZP 5.00/04/270LH SN OR BX	PCB plug-in connector, female plug, 5.00 mm, No. of poles: 4, 90°, Clamping yoke connection, Clamping range, max.: 4 mm <sup>2</sup> , Box	4032248640690	60 pc(s).	Box

## System pitch 5.08 mm (0.200 inch) SL-SMT 5.08/04/90G 3.2SN BK BX

**Weidmüller Interface GmbH & Co. KG**  
 Klingenbergstraße 16  
 D-32758 Detmold  
 Germany  
 Fon: +49 5231 14-0  
 Fax: +49 5231 14-2083  
 www.weidmueller.com

## Counterpart

### BLZ 5.08/180F



Female connectors with clamping yoke screw connection for conductor connection with straight outlet direction. The female connectors provide space for labelling and can be coded. Packed in cardboard box.

- 0.20 - 2.5 mm<sup>2</sup> (IEC) / 26 - 12 AWG (UL)
- 400 V (IEC) / 300 V (UL)
- 19 A (IEC) / 15 A (UL)

### General ordering data

Order No.	Part designation	Version	GTIN (EAN)	Qty.	Packaging
<a href="#">1803060000</a>	BLZ 5.08/04/180F SN BK BX	PCB plug-in connector, female plug, 5.08 mm, No. of poles: 4, 180°, Clamping yoke connection, Clamping range, max.: 3.31 mm <sup>2</sup> , Box	4032248258161	100 pc(s).	Box
<a href="#">1802850000</a>	BLZ 5.08/04/180F SN OR BX	PCB plug-in connector, female plug, 5.08 mm, No. of poles: 4, 180°, Clamping yoke connection, Clamping range, max.: 3.31 mm <sup>2</sup> , Box	4032248257928	100 pc(s).	Box

### BLT 5.08F



Female connectors with TOP screw system for connecting conductors with straight 180° outlet direction. The female connectors include space for labelling and can be coded. Packed in cardboard box.

- 0.20 - 2.5 mm<sup>2</sup> (IEC) / 26 - 14 AWG (UL)
- 400 V (IEC) / 300 V (UL)
- 17 A (IEC) / 10 A (UL)

### General ordering data

Order No.	Part designation	Version	GTIN (EAN)	Qty.	Packaging
<a href="#">1844240000</a>	BLT 5.08/04/180F SN BK BX	PCB plug-in connector, female plug, 5.08 mm, No. of poles: 4, 180°, TOP connection, Clamping range, max.: 2.5 mm <sup>2</sup> , Box	4032248356171	60 pc(s).	Box
<a href="#">1844010000</a>	BLT 5.08/04/180F SN OR BX	PCB plug-in connector, female plug, 5.08 mm, No. of poles: 4, 180°, TOP connection, Clamping range, max.: 2.5 mm <sup>2</sup> , Box	4032248355938	60 pc(s).	Box

## System pitch 5.08 mm (0.200 inch) SL-SMT 5.08/04/90G 3.2SN BK BX

**Weidmüller Interface GmbH & Co. KG**  
Klingenbergstraße 16  
D-32758 Detmold  
Germany  
Fon: +49 5231 14-0  
Fax: +49 5231 14-2083  
www.weidmueller.com

## Counterpart

### BLL 5.08/90FI



Female connector for PCB mounting. The solder pin length is optimised for wave flow soldering. Packed in cardboard box.

- 400 V (IEC) / 300 V (UL)
- 23 A (IEC) / 15 A (UL)

### General ordering data

Order No.	Part designation	Version	GTIN (EAN)	Qty.	Packaging
<a href="#">1843770000</a>	BLL 5.08/04/90FI 3.2SN OR BX	PCB plug-in connector, female header, 5.08 mm, No. of poles: 4, 90°, Solder pin length: 3.2 mm, tinned, Orange, Solder connection, Box	4032248355525	100 pc(s).	Box

### BLF 5.08/90LH SN



Just as reliable as the tried-and-true original, with innovation in detail:

The BLF 5.0x – the PUSH-IN version of the BLZ 5.0x socket block – features a new connection system and a more compact design. Weidmüller's innovative PUSH-IN spring connection features a trend-setting, tool-free wire connection system that is simple to operate.

In terms of versatility, the BLF 5.0x offers just as much as the older versions:

- The choice of three wire outlet directions offers you proven design flexibility for your applications.
- Four flange variations, including the patented release latch, allow for user-friendly unplugging designs.

### General ordering data

Order No.	Part designation	Version	GTIN (EAN)	Qty.	Packaging
<a href="#">1000660001</a>	BLF 5.08/04/90LH SN BK BX	PCB plug-in connector, female plug, 5.08 mm, No. of poles: 4, 90°, PUSH IN, Clamping range, max.: 3.31 mm², Box	4032248690855	60 pc(s).	Box
<a href="#">1002500000</a>	BLF 5.08/04/90LH SN OR BX	PCB plug-in connector, female plug, 5.08 mm, No. of poles: 4, 90°, PUSH IN, Clamping range, max.: 3.31 mm², Box	4032248694877	60 pc(s).	Box