



Chipsmall Limited consists of a professional team with an average of over 10 year of expertise in the distribution of electronic components. Based in Hongkong, we have already established firm and mutual-benefit business relationships with customers from,Europe,America and south Asia,supplying obsolete and hard-to-find components to meet their specific needs.

With the principle of "Quality Parts,Customers Priority,Honest Operation,and Considerate Service",our business mainly focus on the distribution of electronic components. Line cards we deal with include Microchip,ALPS,ROHM,Xilinx,Pulse,ON,Everlight and Freescale. Main products comprise IC,Modules,Potentiometer,IC Socket,Relay,Connector.Our parts cover such applications as commercial,industrial, and automotives areas.

We are looking forward to setting up business relationship with you and hope to provide you with the best service and solution. Let us make a better world for our industry!



Contact us

Tel: +86-755-8981 8866 Fax: +86-755-8427 6832

Email & Skype: info@chipsmall.com Web: www.chipsmall.com

Address: A1208, Overseas Decoration Building, #122 Zhenhua RD., Futian, Shenzhen, China



**System pitch 5.08 mm (0.200 inch)
SL-SMT 5.08/10/90G 3.2SN BK BX**

Weidmüller Interface GmbH & Co. KG
Klingenbergstraße 16
D-32758 Detmold
Germany
Fon: +49 5231 14-0
Fax: +49 5231 14-2083
www.weidmueller.com



High-temperature-resistant male connector, packed in box or tape. In tape with 1.5 mm solder pin optimised for automatic assembly. 3.2 mm solder pin suitable for reflow and wave soldering. These male connectors can be labelled and coded.

- 400 V (IEC) / 300 V (UL)
- 19 A (IEC) / 15 A (UL)

General ordering data

Order No.	1780260000
Part designation	SL-SMT 5.08/10/90G 3.2SN BK BX
Version	PCB plug-in connector, male header, 5.08 mm, No. of poles: 10, 90°, Solder pin length: 3.2 mm, tinned, black, Reflow solder connection, Box
GTIN (EAN)	4032248165582
Qty.	50 pc(s).
Packaging	Box

**System pitch 5.08 mm (0.200 inch)
SL-SMT 5.08/10/90G 3.2SN BK BX**

Weidmüller Interface GmbH & Co. KG
Klingenbergstraße 16
D-32758 Detmold
Germany
Fon: +49 5231 14-0
Fax: +49 5231 14-2083
www.weidmueller.com

Technical data

System parameters

Fitted to PCB	Reflow solder connection	Outgoing elbow	90°
Pitch in mm	5.08 mm	Pitch in inch	0.2 inch
No. of poles	10	Solder pin length	3.2 mm
Can be coded	Yes	No. of rows	1
Number of solder pins per pole	1	L1 in mm	45.72 mm
L1 in inch	1.8 inch		

Material data

Insulating material	LCP GF	Colour	black
Insulating material group	IIIa	Flammability class UL 94	V-0
Contact material	CuSn	Contact surface	tinned
Highest continuous operating temperature, min.	-25 °C	Highest continuous operating temperature, max.	100 °C
Max. relative humidity during storage	80 %		

DIN IEC rating data

Rated current, min. No. of poles (Tu=20°C)	19 A	Rated current, max. No. of poles (Tu=20°C)	15 A
Rated current, no. of poles (Tu=40°C), min.	16 A	Rated current, no. of poles (Tu=40°C), max.	13 A
Rated voltage at overvoltage category/pollution degree III/3	250 V	Rated impulse withstand voltage for overvoltage class/pollution severity III/3	4 kV
Rated voltage for overvoltage class/pollution severity III/2	320 V	Rated impulse withstand voltage for overvoltage class/pollution severity III/2	4 kV
Rated voltage for overvoltage class/pollution severity II/2	400 V	Rated impulse withstand voltage for overvoltage class/pollution severity II/2	4 kV

CSA rating data

Rated voltage (Use group B)	300 V	Rated current (use group B)	15 A
Rated voltage (use group D)	300 V	Rated current (use group D)	10 A

UL 1059 rating data

Rated voltage (use group B)	300 V	Rated current (use group B)	15 A
Rated voltage (use group D)	300 V	Rated current (use group D)	10 A

Approvals

Approvals institutes	CSA; GOSTME25; UR; ROHS
----------------------	-------------------------

Classifications

ETIM 3.0	EC001284	eClass 5.1	27-26-07-04
eClass 6.0	27-26-07-04		

Datasheet

System pitch 5.08 mm (0.200 inch)
SL-SMT 5.08/10/90G 3.2SN BK BX

Weidmüller Interface GmbH & Co. KG
Klingenbergstraße 16
D-32758 Detmold
Germany
Fon: +49 5231 14-0
Fax: +49 5231 14-2083
www.weidmueller.com

Technical data**Notes**

Notes

- Additional colours on request
- Gold-plated contact surfaces on request
- Rated current related to rated cross-section and min. No. of poles.
- Diameter of solder eyelet $D = 1.4 \pm 0.1$ mm
- Diameter of solder eyelet $D = 1.5 \pm 0.1$ mm from 9-pole
- P on drg. = pitch
- Rated data refer only to the component itself. Clearance and creepage distances to other components are to be designed in accordance with the relevant application standards.

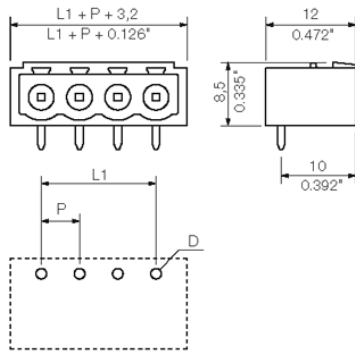
Datasheet**System pitch 5.08 mm (0.200 inch)
SL-SMT 5.08/10/90G 3.2SN BK BX****Weidmüller Interface GmbH & Co. KG**
Klingenbergstraße 16
D-32758 Detmold
Germany
Fon: +49 5231 14-0
Fax: +49 5231 14-2083
www.weidmueller.com**Drawings**

**System pitch 5.08 mm (0.200 inch)
SL-SMT 5.08/10/90G 3.2SN BK BX**

Weidmüller Interface GmbH & Co. KG
Klingenbergstraße 16
D-32758 Detmold
Germany
Fon: +49 5231 14-0
Fax: +49 5231 14-2083
www.weidmueller.com

Counterpart
BLZP 5.08/225 SN

Clamping-yoke wire connection with right-angled (90° or 270°) or angled (225°) outlet direction. The female connectors provide space for labelling and can be coded. Can be fastened with flange or release latch. They feature an integrated plus/minus screw, protection against false insertion under clamping yoke. They are delivered with an opened clamping yoke.

- 0.2-2.5 mm² (IEC) / 26-12 AWG (UL)
- 400 V (IEC) / 300 V (UL)
- 17.5 A (IEC) / 10 A (UL)

General ordering data

Order No.	Part designation	Version	GTIN (EAN)	Qty.	Packaging
1946640000	BLZP 5.08/10/225 SN BK BX	PCB plug-in connector, female plug, 5.08 mm, No. of poles: 10, 225°, Clamping yoke connection, Clamping range, max.: 4 mm ² , Box	4032248622412	36 pc(s).	Box
1946330000	BLZP 5.08/10/225 SN OR BX	PCB plug-in connector, female plug, 5.08 mm, No. of poles: 10, 225°, Clamping yoke connection, Clamping range, max.: 4 mm ² , Box	4032248621903	36 pc(s).	Box

BLZP 5.08/180 SN

Female connectors with clamping yoke screw connection for conductor connection with straight (180°) outlet direction. The female connectors provide space for labelling and can be coded. Can be fastened with flange or release latch. They feature an integrated plus/minus screw, protection against false insertion under clamping yoke. They are delivered with an opened clamping yoke.

- 0.2-2.5 mm² (IEC) / 26-12 AWG (UL)
- 400 V (IEC) / 300 V (UL)
- 19 A (IEC) / 15 A (UL)

General ordering data

Order No.	Part designation	Version	GTIN (EAN)	Qty.	Packaging
1943660000	BLZP 5.08/10/180 SN OR BX	PCB plug-in connector, female plug, 5.08 mm, No. of poles: 10, 180°, Clamping yoke connection, Clamping range, max.: 4 mm ² , Box	4032248617678	45 pc(s).	Box
1943890000	BLZP 5.08/10/180 SN BK BX	PCB plug-in connector, female plug, 5.08 mm, No. of poles: 10, 180°, Clamping yoke connection, Clamping range, max.: 4 mm ² , Box	4032248618002	45 pc(s).	Box

System pitch 5.08 mm (0.200 inch) SL-SMT 5.08/10/90G 3.2SN BK BX

Weidmüller Interface GmbH & Co. KG
 Klingenbergstraße 16
 D-32758 Detmold
 Germany
 Fon: +49 5231 14-0
 Fax: +49 5231 14-2083
 www.weidmueller.com

Counterpart

BLZP 5.00/270 SN

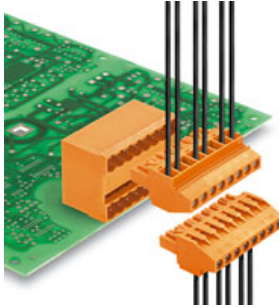

Socket connectors with clamping yoke screw connection for conductor connection with a right-angle (90° or 270°) outlet direction. The female connectors provide space for labelling and can be coded. Can be fastened with flange or release latch. They feature an integrated plus/minus screw, protection against false insertion under clamping yoke. They are delivered with an opened clamping yoke.

- 0.2-2.5 mm² (IEC) / 26-12 AWG (UL)
- 400 V (IEC) / 300 V (UL)
- 15 A (IEC) / 10 A (UL)

General ordering data

Order No.	Part designation	Version	GTIN (EAN)	Qty.	Packaging
1959020000	BLZP 5.00/10/270 SN BK BX	PCB plug-in connector, female plug, 5.00 mm, No. of poles: 10, 90°, Clamping yoke connection, Clamping range, max.: 4 mm ² , Box	4032248637959	36 pc(s).	Box
1958790000	BLZP 5.00/10/270 SN OR BX	PCB plug-in connector, female plug, 5.00 mm, No. of poles: 10, 90°, Clamping yoke connection, Clamping range, max.: 4 mm ² , Box	4032248637621	36 pc(s).	Box

BLF 5.08/90 SN



Just as reliable as the tried-and-true original, with innovation in detail:

The BLF 5.0x – the PUSH-IN version of the BLZ 5.0x socket block – features a new connection system and a more compact design. Weidmüller's innovative PUSH-IN spring connection features a trend-setting, tool-free wire connection system that is simple to operate.

In terms of versatility, the BLF 5.0x offers just as much as the older versions:

- The choice of three wire outlet directions offers you proven design flexibility for your applications.
- Four flange variations, including the patented release latch, allow for user-friendly unplugging designs.

General ordering data

Order No.	Part designation	Version	GTIN (EAN)	Qty.	Packaging
1001610000	BLF 5.08/10/90 SN OR BX	PCB plug-in connector, female plug, 5.08 mm, No. of poles: 10, 90°, PUSH IN, Clamping range, max.: 3.31 mm ² , Box	4032248693412	36 pc(s).	Box
1000110001	BLF 5.08/10/90 SN BK BX	PCB plug-in connector, female plug, 5.08 mm, No. of poles: 10, 90°, PUSH IN, Clamping range, max.: 3.31 mm ² , Box	4032248690046	36 pc(s).	Box

System pitch 5.08 mm (0.200 inch) SL-SMT 5.08/10/90G 3.2SN BK BX

Weidmüller Interface GmbH & Co. KG
 Klingenbergstraße 16
 D-32758 Detmold
 Germany
 Fon: +49 5231 14-0
 Fax: +49 5231 14-2083
 www.weidmueller.com

Counterpart

BLZ 5.00/270



Female connectors with clamping yoke screw connection. The female connectors provide space for labelling and can be coded. Packed in cardboard box.

- 0.20 - 2.5 mm² (IEC) / 26 - 12 AWG (UL)
- 400 V (IEC) / 300 V (UL)
- 15 A (IEC) / 10 A (UL)

General ordering data

Order No.	Part designation	Version	GTIN (EAN)	Qty.	Packaging
1637890000	BLZ 5.00/10/270 SN BK BX	PCB plug-in connector, female plug, 5.00 mm, No. of poles: 10, 270°, Clamping yoke connection, Clamping range, max.: 3.31 mm ² , Box	4008190275150	36 pc(s).	Box
1637660000	BLZ 5.00/10/270 SN OR BX	PCB plug-in connector, female plug, 5.00 mm, No. of poles: 10, 270°, Clamping yoke connection, Clamping range, max.: 3.31 mm ² , Box	4008190274900	36 pc(s).	Box

BLL 5.08/180



Female connector for PCB mounting. The solder pin length is optimised for wave flow soldering. Packed in cardboard box.

- 400 V (IEC) / 300 V (UL)
- 23 A (IEC) / 15 A (UL)

General ordering data

Order No.	Part designation	Version	GTIN (EAN)	Qty.	Packaging
1630790000	BLL 5.08/10/180 3.2SN OR BX	PCB plug-in connector, female header, 5.08 mm, No. of poles: 10, 180°, Solder pin length: 3.2 mm, tinned, Orange, Solder connection, Box	4008190204228	50 pc(s).	Box

System pitch 5.08 mm (0.200 inch) SL-SMT 5.08/10/90G 3.2SN BK BX

Weidmüller Interface GmbH & Co. KG
 Klingenbergstraße 16
 D-32758 Detmold
 Germany
 Fon: +49 5231 14-0
 Fax: +49 5231 14-2083
 www.weidmueller.com

Counterpart

BLZF 5.08/180



Female connectors for connecting conductors with tension clamp system, straight 180° outlet direction. The female connectors include space for labelling and can be coded. Packed in cardboard box.

- 0.20 - 2.5 mm² (IEC) / 26 - 12 AWG (UL)
- 400 V (IEC) / 300 V (UL)
- 17 A (IEC) / 15 A (UL)

General ordering data

Order No.	Part designation	Version	GTIN (EAN)	Qty.	Packaging
1707770000	BLZF 5.08/10/180 SN BK BX	PCB plug-in connector, female plug, 5.08 mm, No. of poles: 10, 180°, Tension clamp connection, Clamping range, max.: 3.31 mm ² , Box	4008190316778	36 pc(s).	Box
1707540000	BLZF 5.08/10/180 SN OR BX	PCB plug-in connector, female plug, 5.08 mm, No. of poles: 10, 180°, Tension clamp connection, Clamping range, max.: 3.31 mm ² , Box	4008190950200	36 pc(s).	Box

BLF 5.00/90 SN



Just as reliable as the tried-and-true original, with innovation in detail:

The BLF 5.0x – the PUSH-IN version of the BLZ 5.0x socket block – features a new connection system and a more compact design. Weidmüller's innovative PUSH-IN spring connection features a trend-setting, tool-free wire connection system that is simple to operate.

In terms of versatility, the BLF 5.0x offers just as much as the older versions:

- The choice of three wire outlet directions offers you proven design flexibility for your applications.
- Four flange variations, including the patented release latch, allow for user-friendly unplugging designs.

General ordering data

Order No.	Part designation	Version	GTIN (EAN)	Qty.	Packaging
1979350000	BLF 5.00/10/90 SN BK BX	PCB plug-in connector, female plug, 5.00 mm, No. of poles: 10, 90°, PUSH IN, Clamping range, max.: 3.31 mm ² , Box	4032248674558	36 pc(s).	Box
1980250000	BLF 5.00/10/90 SN OR BX	PCB plug-in connector, female plug, 5.00 mm, No. of poles: 10, 90°, PUSH IN, Clamping range, max.: 3.31 mm ² , Box	4032248675333	36 pc(s).	Box

System pitch 5.08 mm (0.200 inch) SL-SMT 5.08/10/90G 3.2SN BK BX

Weidmüller Interface GmbH & Co. KG
 Klingenbergstraße 16
 D-32758 Detmold
 Germany
 Fon: +49 5231 14-0
 Fax: +49 5231 14-2083
 www.weidmueller.com

Counterpart

BLZP 5.00/90 SN



Socket connectors with clamping yoke screw connection for conductor connection with a right-angle (90° or 270°) outlet direction. The female connectors provide space for labelling and can be coded. Can be fastened with flange or release latch. They feature an integrated plus/minus screw, protection against false insertion under clamping yoke. They are delivered with an opened clamping yoke.

- 0.2-2.5 mm² (IEC) / 26-12 AWG (UL)
- 400 V (IEC) / 300 V (UL)
- 15 A (IEC) / 10 A (UL)

General ordering data

Order No.	Part designation	Version	GTIN (EAN)	Qty.	Packaging
1958570000	BLZP 5.00/10/90 SN BK BX	PCB plug-in connector, female plug, 5.00 mm, No. of poles: 10, 90°, Clamping yoke connection, Clamping range, max.: 4 mm ² , Box	4032248637317	36 pc(s).	Box
1958160000	BLZP 5.00/10/90 SN OR BX	PCB plug-in connector, female plug, 5.00 mm, No. of poles: 10, 90°, Clamping yoke connection, Clamping range, max.: 4 mm ² , Box	4032248637089	36 pc(s).	Box

BLIDC 5.08



Female connectors for conductor connection with IDC system. The female connectors provide space for labelling and can be coded. Packed in cardboard box.

- 0.35 - 0.75 mm² (IEC) / 22 - 20 AWG (UL)
- 400 V (IEC) / 300 V (UL)
- 11 A (IEC) / 5 A (UL)

General ordering data

Order No.	Part designation	Version	GTIN (EAN)	Qty.	Packaging
1725020000	BLIDC 5.08/10/180 SN OR BX	PCB plug-in connector, female plug, 5.08 mm, No. of poles: 10, 180°, IDC terminal, Clamping range, max.: 0.75 mm ² , Box	4008190377366	50 pc(s).	Box

System pitch 5.08 mm (0.200 inch) SL-SMT 5.08/10/90G 3.2SN BK BX

Weidmüller Interface GmbH & Co. KG
 Klingenbergstraße 16
 D-32758 Detmold
 Germany
 Fon: +49 5231 14-0
 Fax: +49 5231 14-2083
 www.weidmueller.com

Counterpart

BLZ 5.00/90

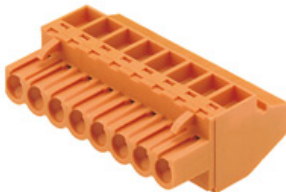

Female connectors with clamping yoke screw connection. The female connectors provide space for labelling and can be coded. Packed in cardboard box.

- 0.20 - 2.5 mm² (IEC) / 26 - 12 AWG (UL)
- 400 V (IEC) / 300 V (UL)
- 15 A (IEC) / 10 A (UL)

General ordering data

Order No.	Part designation	Version	GTIN (EAN)	Qty.	Packaging
1636970000	BLZ 5.00/10/90 SN BK BX	PCB plug-in connector, female plug, 5.00 mm, No. of poles: 10, 90°, Clamping yoke connection, Clamping range, max.: 3.31 mm ² , Box	4008190274214	36 pc(s).	Box
1636020000	BLZ 5.00/10/90 SN OR BX	PCB plug-in connector, female plug, 5.00 mm, No. of poles: 10, 90°, Clamping yoke connection, Clamping range, max.: 3.31 mm ² , Box	4008190265779	36 pc(s).	Box

BLZF 5.08/90



Female connectors for connecting conductors with tension clamp system. The female connectors include space for labelling and can be coded. Packed in cardboard box.

- 0.20 - 2.5 mm² (IEC) / 26 - 12 AWG (UL)
- 400 V (IEC) / 300 V (UL)
- 16.5 A (IEC) / 10 A (UL)

General ordering data

Order No.	Part designation	Version	GTIN (EAN)	Qty.	Packaging
1671100000	BLZF 5.08/10/90 SN BK BX	PCB plug-in connector, female plug, 5.08 mm, No. of poles: 10, 90°, Tension clamp connection, Clamping range, max.: 3.31 mm ² , Box	4008190432775	36 pc(s).	Box
1670870000	BLZF 5.08/10/90 SN OR BX	PCB plug-in connector, female plug, 5.08 mm, No. of poles: 10, 90°, Tension clamp connection, Clamping range, max.: 3.31 mm ² , Box	4008190432461	36 pc(s).	Box

System pitch 5.08 mm (0.200 inch) SL-SMT 5.08/10/90G 3.2SN BK BX

Weidmüller Interface GmbH & Co. KG
 Klingenbergstraße 16
 D-32758 Detmold
 Germany
 Fon: +49 5231 14-0
 Fax: +49 5231 14-2083
 www.weidmueller.com

Counterpart

BL 5.00



Female connectors for conductor connection in leaf spring system. Packed in cardboard box. The female connectors provide space for labelling. Packed in cardboard box.

- 0.2 - 1.5 mm² (IEC) / 26 - 14 AWG (UL)
- 400 V (IEC) / 300 V (UL)
- 11 A (IEC) / 10 A (UL)

General ordering data

Order No.	Part designation	Version	GTIN (EAN)	Qty.	Packaging
1723190000	BL 5.00/10/180 SN OR BX	PCB plug-in connector, female plug, 5.00 mm, No. of poles: 10, 180°, Leaf spring connection, Clamping range, max.: 2.08 mm ² , Box	4032248002597	50 pc(s).	Box
1730780000	BL 5.00/10/180 SN BK BX	PCB plug-in connector, female plug, 5.00 mm, No. of poles: 10, 180°, Leaf spring connection, Clamping range, max.: 2.08 mm ² , Box	4008190387259	50 pc(s).	Box

BLZP 5.00/180 SN



Female connectors with clamping yoke screw connection for conductor connection with straight (180°) outlet direction. The female connectors provide space for labelling and can be coded. Can be fastened with flange or release latch. They feature an integrated plus/minus screw, protection against false insertion under clamping yoke. They are delivered with an opened clamping yoke.

- 0.2-2.5 mm² (IEC) / 26-12 AWG (UL)
- 400 V (IEC) / 300 V (UL)
- 19 A (IEC) / 15 A (UL)

General ordering data

Order No.	Part designation	Version	GTIN (EAN)	Qty.	Packaging
1954410000	BLZP 5.00/10/180 SN OR BX	PCB plug-in connector, female plug, 5.00 mm, No. of poles: 10, 180°, Clamping yoke connection, Clamping range, max.: 4 mm ² , Box	4032248633128	45 pc(s).	Box
1955490000	BLZP 5.00/10/180 SN BK BX	PCB plug-in connector, female plug, 5.00 mm, No. of poles: 10, 180°, Clamping yoke connection, Clamping range, max.: 4 mm ² , Box	4032248633982	45 pc(s).	Box

**System pitch 5.08 mm (0.200 inch)
SL-SMT 5.08/10/90G 3.2SN BK BX**

Weidmüller Interface GmbH & Co. KG
Klingenbergstraße 16
D-32758 Detmold
Germany
Fon: +49 5231 14-0
Fax: +49 5231 14-2083
www.weidmueller.com

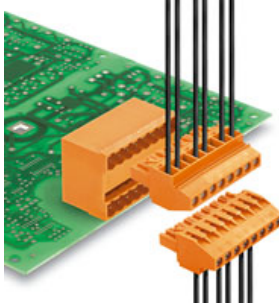
Counterpart
BLZP 5.08/270 SN

Socket connectors with clamping yoke screw connection for conductor connection with a right-angle (90° or 270°) outlet direction. The female connectors provide space for labelling and can be coded. Can be fastened with flange or release latch. They feature an integrated plus/minus screw, protection against false insertion under clamping yoke. They are delivered with an opened clamping yoke.

- 0.2-2.5 mm² (IEC) / 26-12 AWG (UL)
- 400 V (IEC) / 300 V (UL)
- 15 A (IEC) / 10 A (UL)

General ordering data

Order No.	Part designation	Version	GTIN (EAN)	Qty.	Packaging
1949100000	BLZP 5.08/10/270 SN BK BX	PCB plug-in connector, female plug, 5.08 mm, No. of poles: 10, 270°, Clamping yoke connection, Clamping range, max.: 4 mm ² , Box	4032248626557	36 pc(s).	Box
1948870000	BLZP 5.08/10/270 SN OR BX	PCB plug-in connector, female plug, 5.08 mm, No. of poles: 10, 270°, Clamping yoke connection, Clamping range, max.: 4 mm ² , Box	4032248626328	36 pc(s).	Box

BLZFS 5.00/180

Female connectors for connecting conductors with tension clamp system, straight 180° outlet direction in thin-element design. The female connectors include space for labelling and can be coded. Packed in cardboard box.

- 0.20 - 2.5 mm² (IEC) / 26 - 14 AWG (UL)
- 400 V (IEC) / 300 V (UL)
- 17 A (IEC) / 10 A (UL)

General ordering data

Order No.	Part designation	Version	GTIN (EAN)	Qty.	Packaging
1696450000	BLZFS 5.00/10/180 SN OR BX	PCB plug-in connector, female plug, 5.00 mm, No. of poles: 10, 180°, Tension clamp connection, Clamping range, max.: 2.5 mm ² , Box	4008190878474	50 pc(s).	Box
1696680000	BLZFS 5.00/10/180 SN BK BX	PCB plug-in connector, female plug, 5.00 mm, No. of poles: 10, 180°, Tension clamp connection, Clamping range, max.: 2.5 mm ² , Box	4008190878702	50 pc(s).	Box

System pitch 5.08 mm (0.200 inch) SL-SMT 5.08/10/90G 3.2SN BK BX

Weidmüller Interface GmbH & Co. KG
Klingenbergstraße 16
D-32758 Detmold
Germany
Fon: +49 5231 14-0
Fax: +49 5231 14-2083
www.weidmueller.com

Counterpart

BL 5.08



Female connectors for conductor connection in leaf spring system. Packed in cardboard box. The female connectors provide space for labelling. Packed in cardboard box.

- 0.2 - 1.5 mm² (IEC) / 26 - 14 AWG (UL)
- 400 V (IEC) / 300 V (UL)
- 11 A (IEC) / 10 A (UL)

General ordering data

Order No.	Part designation	Version	GTIN (EAN)	Qty.	Packaging
171640000	BL 5.08/10/180 SN OR BX	PCB plug-in connector, female plug, 5.08 mm, No. of poles: 10, 180°, Leaf spring connection, Clamping range, max.: 2.08 mm ² , Box	4008190376444	50 pc(s).	Box
1723910000	BL 5.08/10/180 SN DKGX BX	PCB plug-in connector, female plug, 5.08 mm, No. of poles: 10, 180°, Leaf spring connection, Clamping range, max.: 2.08 mm ² , Box	4008190376277	50 pc(s).	Box
1716550000	BL 5.08/10/180 SN BK BX	PCB plug-in connector, female plug, 5.08 mm, No. of poles: 10, 180°, Leaf spring connection, Clamping range, max.: 2.08 mm ² , Box	4008190376628	50 pc(s).	Box

BLZ 5.00/180



Female connectors with clamping yoke screw connection for conductor connection with straight outlet direction. The female connectors provide space for labelling and can be coded. Packed in cardboard box.

- 0.20 - 2.5 mm² (IEC) / 26 - 12 AWG (UL)
- 400 V (IEC) / 300 V (UL)
- 19 A (IEC) / 15 A (UL)

General ordering data

Order No.	Part designation	Version	GTIN (EAN)	Qty.	Packaging
1571430000	BLZ 5.00/10/180 SN OR BX	PCB plug-in connector, female plug, 5.00 mm, No. of poles: 10, 180°, Clamping yoke connection, Clamping range, max.: 3.31 mm ² , Box	4008190163488	50 pc(s).	Box
1596120000	BLZ 5.00/10/180 SN BK BX	PCB plug-in connector, female plug, 5.00 mm, No. of poles: 10, 180°, Clamping yoke	4008190170417	50 pc(s).	Box

System pitch 5.08 mm (0.200 inch) SL-SMT 5.08/10/90G 3.2SN BK BX

Weidmüller Interface GmbH & Co. KG
 Klingenbergstraße 16
 D-32758 Detmold
 Germany
 Fon: +49 5231 14-0
 Fax: +49 5231 14-2083
 www.weidmueller.com

Counterpart

connection, Clamping range,
 max.: 3.31 mm², Box

BLT 5.08



Female connectors with TOP screw system for connecting conductors with straight 180° outlet direction. The female connectors include space for labelling and can be coded. Packed in cardboard box.

- 0.20 - 2.5 mm² (IEC) / 26 - 14 AWG (UL)
- 400 V (IEC) / 300 V (UL)
- 17 A (IEC) / 10 A (UL)

General ordering data

Order No.	Part designation	Version	GTIN (EAN)	Qty.	Packaging
1500360000	BLT 5.08/10/180 SN OR BX	PCB plug-in connector, female plug, 5.08 mm, No. of poles: 10, 180°, TOP connection, Clamping range, max.: 2.5 mm ² , Box	4008190103422	36 pc(s).	Box
1500310000	BLT 5.08/10/180 SN BK BX	PCB plug-in connector, female plug, 5.08 mm, No. of poles: 10, 180°, TOP connection, Clamping range, max.: 2.5 mm ² , Box	4008190861766	36 pc(s).	Box

BLC 5.08R

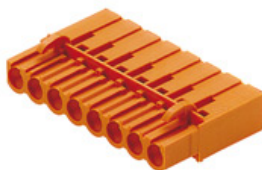

Female connectors for conductor connection with crimp connection system. The female connectors provide space for labelling and can be coded. Packed in cardboard box.

- 0.25 - 2.5 mm² (IEC) / 26 - 14 AWG (UL)
- 400 V (IEC) / 300 V (UL)
- 21 A (IEC) / 10 A (UL)

General ordering data

Order No.	Part designation	Version	GTIN (EAN)	Qty.	Packaging
1712040000	BLC 5.08/10/180R BK BX	PCB plug-in connector, female plug, 5.08 mm, No. of poles: 10, 180°, Crimp connection, Clamping range, max.: 2.5 mm ² , Box	4008190935054	50 pc(s).	Box
1610570000	BLC 5.08/10/180R OR BX	PCB plug-in connector, female plug, 5.08 mm, No. of poles: 10, 180°, Crimp connection,	4008190128180	50 pc(s).	Box

System pitch 5.08 mm (0.200 inch) SL-SMT 5.08/10/90G 3.2SN BK BX

Weidmüller Interface GmbH & Co. KG
 Klingenbergstraße 16
 D-32758 Detmold
 Germany
 Fon: +49 5231 14-0
 Fax: +49 5231 14-2083
 www.weidmueller.com

Counterpart

Clamping range, max.: 2.5
mm², Box

BLZ 5.08/180



Female connectors with clamping yoke screw connection for conductor connection with straight outlet direction. The female connectors provide space for labelling and can be coded. Packed in cardboard box.

- 0.20 - 2.5 mm² (IEC) / 26 - 12 AWG (UL)
- 400 V (IEC) / 300 V (UL)
- 19 A (IEC) / 15 A (UL)

General ordering data

Order No.	Part designation	Version	GTIN (EAN)	Qty.	Packaging
1527260000	BLZ 5.08/10/180 SN OR BX	PCB plug-in connector, female plug, 5.08 mm, No. of poles: 10, 180°, Clamping yoke connection, Clamping range, max.: 3.31 mm ² , Box	4008190186265	50 pc(s).	Box
1527210000	BLZ 5.08/10/180 SN BK BX	PCB plug-in connector, female plug, 5.08 mm, No. of poles: 10, 180°, Clamping yoke connection, Clamping range, max.: 3.31 mm ² , Box	4008190015602	50 pc(s).	Box

BLDT 5.08

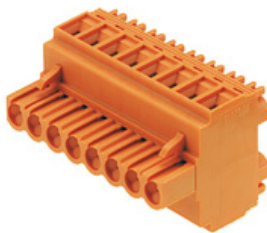

Female connectors with two clamping yoke screw connections per pole for conductor connection with 90° & 270° outlet direction. The female connectors provide space for labelling and can be coded. Packed in cardboard box.

- 0.20 - 2.5 mm² (IEC) / 26 - 12 AWG (UL)
- 400 V (IEC) / 300 V (UL)
- 14 A (IEC) / 10 A (UL)

General ordering data

Order No.	Part designation	Version	GTIN (EAN)	Qty.	Packaging
1644810000	BLDT 5.08/10/- SN OR BX	PCB plug-in connector, female plug, 5.08 mm, No. of poles: 10, 90°/270°, Clamping yoke connection, Clamping range, max.: 3.31 mm ² , Box	4008190284022	50 pc(s).	Box
1660790000	BLDT 5.08/10/- SN BK BX	PCB plug-in connector, female plug, 5.08 mm, No. of poles: 10, 90°/270°, Clamping yoke	4008190417246	50 pc(s).	Box

System pitch 5.08 mm (0.200 inch) SL-SMT 5.08/10/90G 3.2SN BK BX

Weidmüller Interface GmbH & Co. KG
 Klingenbergstraße 16
 D-32758 Detmold
 Germany
 Fon: +49 5231 14-0
 Fax: +49 5231 14-2083
 www.weidmueller.com

Counterpart

connection, Clamping range,
 max.: 3.31 mm², Box

BLZ 5.08/90



Female connectors with clamping yoke screw connection. The female connectors provide space for labelling and can be coded. Packed in cardboard box.

- 0.20 - 2.5 mm² (IEC) / 26 - 12 AWG (UL)
- 400 V (IEC) / 300 V (UL)
- 15 A (IEC) / 10 A (UL)

General ordering data

Order No.	Part designation	Version	GTIN (EAN)	Qty.	Packaging
1553510000	BLZ 5.08/10/90 SN BK BX	PCB plug-in connector, female plug, 5.08 mm, No. of poles: 10, 90°, Clamping yoke connection, Clamping range, max.: 3.31 mm ² , Box	4008190267797	36 pc(s).	Box
1553560000	BLZ 5.08/10/90 SN OR BX	PCB plug-in connector, female plug, 5.08 mm, No. of poles: 10, 90°, Clamping yoke connection, Clamping range, max.: 3.31 mm ² , Box	4008190016852	36 pc(s).	Box

BLL 5.08/90



Female connector for PCB mounting. The solder pin length is optimised for wave flow soldering. Packed in cardboard box.

- 400 V (IEC) / 300 V (UL)
- 23 A (IEC) / 15 A (UL)

General ordering data

Order No.	Part designation	Version	GTIN (EAN)	Qty.	Packaging
1623020000	BLL 5.08/10/90 3.2SN OR BX	PCB plug-in connector, female header, 5.08 mm, No. of poles: 10, 90°, Solder pin length: 3.2 mm, tinned, Orange, Solder connection, Box	4008190194079	50 pc(s).	Box

System pitch 5.08 mm (0.200 inch) SL-SMT 5.08/10/90G 3.2SN BK BX

Weidmüller Interface GmbH & Co. KG
 Klingenbergstraße 16
 D-32758 Detmold
 Germany
 Fon: +49 5231 14-0
 Fax: +49 5231 14-2083
 www.weidmueller.com

Counterpart

BLZ 5.08/225



Female connectors with clamping yoke screw connection for conductor connection with 225° outlet direction. The female connectors provide space for labelling and can be coded. Packed in cardboard box.

- 0.20 - 2.5 mm² (IEC) / 26 - 12 AWG (UL)
- 400 V (IEC) / 300 V (UL)
- 16.5 A (IEC) / 10 A (UL)

General ordering data

Order No.	Part designation	Version	GTIN (EAN)	Qty.	Packaging
1741720000	BLZ 5.08/10/225 SN OR BX	PCB plug-in connector, female plug, 5.08 mm, No. of poles: 10, 225°, Clamping yoke connection, Clamping range, max.: 3.31 mm ² , Box	4008190222246	36 pc(s).	Box
1741950000	BLZ 5.08/10/225 SN BK BX	PCB plug-in connector, female plug, 5.08 mm, No. of poles: 10, 225°, Clamping yoke connection, Clamping range, max.: 3.31 mm ² , Box	4008190272883	36 pc(s).	Box

BLZ 5.08/270



Female connectors with clamping yoke screw connection. The female connectors provide space for labelling and can be coded. Packed in cardboard box.

- 0.20 - 2.5 mm² (IEC) / 26 - 12 AWG (UL)
- 400 V (IEC) / 300 V (UL)
- 15 A (IEC) / 10 A (UL)

General ordering data

Order No.	Part designation	Version	GTIN (EAN)	Qty.	Packaging
1558110000	BLZ 5.08/10/270 SN BK BX	PCB plug-in connector, female plug, 5.08 mm, No. of poles: 10, 270°, Clamping yoke connection, Clamping range, max.: 3.31 mm ² , Box	4008190269500	36 pc(s).	Box
1558160000	BLZ 5.08/10/270 SN OR BX	PCB plug-in connector, female plug, 5.08 mm, No. of poles: 10, 270°, Clamping yoke connection, Clamping range, max.: 3.31 mm ² , Box	4008190184247	36 pc(s).	Box

Datasheet

System pitch 5.08 mm (0.200 inch)
SL-SMT 5.08/10/90G 3.2SN BK BX

Weidmüller Interface GmbH & Co. KG
 Klingenbergstraße 16
 D-32758 Detmold
 Germany
 Fon: +49 5231 14-0
 Fax: +49 5231 14-2083
 www.weidmueller.com

Counterpart

BLZF 5.08/270



Female connectors for connecting conductors with tension clamp system. The female connectors include space for labelling and can be coded. Packed in cardboard box.

- 0.20 - 2.5 mm² (IEC) / 26 - 12 AWG (UL)
- 400 V (IEC) / 300 V (UL)
- 16.5 A (IEC) / 10 A (UL)

General ordering data

Order No.	Part designation	Version	GTIN (EAN)	Qty.	Packaging
1672020000	BLZF 5.08/10/270 SN OR BX	PCB plug-in connector, female plug, 5.08 mm, No. of poles: 10, 270°, Tension clamp connection, Clamping range, max.: 3.31 mm ² , Box	4008190433734	36 pc(s).	Box
1672250000	BLZF 5.08/10/270 SN BK BX	PCB plug-in connector, female plug, 5.08 mm, No. of poles: 10, 270°, Tension clamp connection, Clamping range, max.: 3.31 mm ² , Box	4008190433963	36 pc(s).	Box

System pitch 5.08 mm (0.200 inch) SL-SMT 5.08/10/90G 3.2SN BK BX

Weidmüller Interface GmbH & Co. KG
 Klingenbergstraße 16
 D-32758 Detmold
 Germany
 Fon: +49 5231 14-0
 Fax: +49 5231 14-2083
 www.weidmueller.com

Counterpart

BLZP 5.08/270F SN



Socket connectors with clamping yoke screw connection for conductor connection with a right-angle (90° or 270°) outlet direction. The female connectors provide space for labelling and can be coded. Can be fastened with flange or release latch. They feature an integrated plus/minus screw, protection against false insertion under clamping yoke. They are delivered with an opened clamping yoke.

- 0.2-2.5 mm² (IEC) / 26-12 AWG (UL)
- 400 V (IEC) / 300 V (UL)
- 15 A (IEC) / 10 A (UL)

General ordering data

Order No.	Part designation	Version	GTIN (EAN)	Qty.	Packaging
1950390000	BLZP 5.08/10/270F SN OR BX	PCB plug-in connector, female plug, 5.08 mm, No. of poles: 10, 270°, Clamping yoke connection, Clamping range, max.: 4 mm ² , Box	4032248628513	30 pc(s).	Box
1950660000	BLZP 5.08/10/270F SN BK BX	PCB plug-in connector, female plug, 5.08 mm, No. of poles: 10, 270°, Clamping yoke connection, Clamping range, max.: 4 mm ² , Box	4032248629039	30 pc(s).	Box

BLZP 5.08/180F SN



Female connectors with clamping yoke screw connection for conductor connection with straight (180°) outlet direction. The female connectors provide space for labelling and can be coded. Can be fastened with flange or release latch. They feature an integrated plus/minus screw, protection against false insertion under clamping yoke. They are delivered with an opened clamping yoke.

- 0.2-2.5 mm² (IEC) / 26-12 AWG (UL)
- 400 V (IEC) / 300 V (UL)
- 19 A (IEC) / 15 A (UL)

General ordering data

Order No.	Part designation	Version	GTIN (EAN)	Qty.	Packaging
1944170000	BLZP 5.08/10/180F SN OR BX	PCB plug-in connector, female plug, 5.08 mm, No. of poles: 10, 180°, Clamping yoke connection, Clamping range, max.: 4 mm ² , Box	4032248618750	36 pc(s).	Box
1944410000	BLZP 5.08/10/180F SN BK BX	PCB plug-in connector, female plug, 5.08 mm, No. of poles: 10, 180°, Clamping yoke connection, Clamping range, max.: 4 mm ² , Box	4032248618989	36 pc(s).	Box

System pitch 5.08 mm (0.200 inch) SL-SMT 5.08/10/90G 3.2SN BK BX

Weidmüller Interface GmbH & Co. KG
 Klingenbergstraße 16
 D-32758 Detmold
 Germany
 Fon: +49 5231 14-0
 Fax: +49 5231 14-2083
 www.weidmueller.com

Counterpart

BLZP 5.00/270F SN

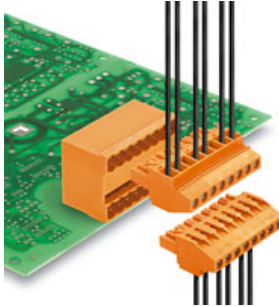

Socket connectors with clamping yoke screw connection for conductor connection with a right-angle (90° or 270°) outlet direction. The female connectors provide space for labelling and can be coded. Can be fastened with flange or release latch. They feature an integrated plus/minus screw, protection against false insertion under clamping yoke. They are delivered with an opened clamping yoke.

- 0.2-2.5 mm² (IEC) / 26-12 AWG (UL)
- 400 V (IEC) / 300 V (UL)
- 15 A (IEC) / 10 A (UL)

General ordering data

Order No.	Part designation	Version	GTIN (EAN)	Qty.	Packaging
1960640000	BLZP 5.00/10/270F SN BK BX	PCB plug-in connector, female plug, 5.00 mm, No. of poles: 10, 90°, Clamping yoke connection, Clamping range, max.: 4 mm ² , Box	4032248639601	30 pc(s).	Box
1960380000	BLZP 5.00/10/270F SN OR BX	PCB plug-in connector, female plug, 5.00 mm, No. of poles: 10, 90°, Clamping yoke connection, Clamping range, max.: 4 mm ² , Box	4032248639243	30 pc(s).	Box

BLZ 5.08/180LH



Socket connectors with clamping yoke screw connection for conductor connection with 270° outlet direction and release lever or release latch mechanism. The female connectors provide space for labelling and can be coded. Packed in cardboard box.br/>

- 0.20–1.5 mm² (IEC) / 26–12 AWG (UL)
- 400 V (IEC) / 300 V (UL)
- 19 A (IEC) / 15 A (UL)

General ordering data

Order No.	Part designation	Version	GTIN (EAN)	Qty.	Packaging
1893680000	BLZ 5.08/10/180LH SN BK BX	PCB plug-in connector, female plug, 5.08 mm, No. of poles: 10, 180°, Clamping yoke connection, Clamping range, max.: 3.31 mm ² , Box	4032248507863	40 pc(s).	Box
1892270000	BLZ 5.08/10/180LH SN OR BX	PCB plug-in connector, female plug, 5.08 mm, No. of poles: 10, 180°, Clamping yoke connection, Clamping range, max.: 3.31 mm ² , Box	4032248505678	40 pc(s).	Box

System pitch 5.08 mm (0.200 inch) SL-SMT 5.08/10/90G 3.2SN BK BX

Weidmüller Interface GmbH & Co. KG
 Klingenbergstraße 16
 D-32758 Detmold
 Germany
 Fon: +49 5231 14-0
 Fax: +49 5231 14-2083
 www.weidmueller.com

Counterpart

BLZ 5.00/90B

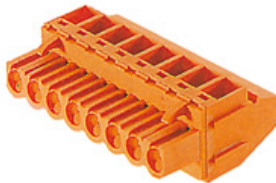

Female connectors with clamping yoke screw connection. The female connectors provide space for labelling and can be coded. Packed in cardboard box.

- 0.20 - 2.5 mm² (IEC) / 26 - 12 AWG (UL)
- 400 V (IEC) / 300 V (UL)
- 15 A (IEC) / 10 A (UL)

General ordering data

Order No.	Part designation	Version	GTIN (EAN)	Qty.	Packaging
1637200000	BLZ 5.00/10/90B SN OR BX	PCB plug-in connector, female plug, 5.00 mm, No. of poles: 10, 90°, Clamping yoke connection, Clamping range, max.: 3.31 mm ² , Box	4008190274443	30 pc(s).	Box
1637430000	BLZ 5.00/10/90B SN BK BX	PCB plug-in connector, female plug, 5.00 mm, No. of poles: 10, 90°, Clamping yoke connection, Clamping range, max.: 3.31 mm ² , Box	4008190274672	30 pc(s).	Box

BLZP 5.08/90F SN

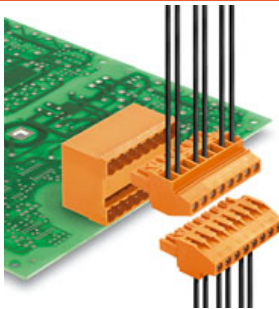

Socket connectors with clamping yoke screw connection for conductor connection with a right-angle (90° or 270°) outlet direction. The female connectors provide space for labelling and can be coded. Can be fastened with flange or release latch. They feature an integrated plus/minus screw, protection against false insertion under clamping yoke. They are delivered with an opened clamping yoke.

- 0.2-2.5 mm² (IEC) / 26-12 AWG (UL)
- 400 V (IEC) / 300 V (UL)
- 15 A (IEC) / 10 A (UL)

General ordering data

Order No.	Part designation	Version	GTIN (EAN)	Qty.	Packaging
1950120000	BLZP 5.08/10/90F SN BK BX	PCB plug-in connector, female plug, 5.08 mm, No. of poles: 10, 90°, Clamping yoke connection, Clamping range, max.: 4 mm ² , Box	4032248628056	30 pc(s).	Box
1949880000	BLZP 5.08/10/90F SN OR BX	PCB plug-in connector, female plug, 5.08 mm, No. of poles: 10, 90°, Clamping yoke connection, Clamping range, max.: 4 mm ² , Box	4032248627806	30 pc(s).	Box

System pitch 5.08 mm (0.200 inch) SL-SMT 5.08/10/90G 3.2SN BK BX

Weidmüller Interface GmbH & Co. KG
 Klingenbergstraße 16
 D-32758 Detmold
 Germany
 Fon: +49 5231 14-0
 Fax: +49 5231 14-2083
 www.weidmueller.com

Counterpart

BLZP 5.00/270LH SN



Socket connectors with clamping yoke screw connection for conductor connection with a right-angle (90° or 270°) outlet direction. The female connectors provide space for labelling and can be coded. Can be fastened with flange or release latch. They feature an integrated plus/minus screw, protection against false insertion under clamping yoke. They are delivered with an opened clamping yoke.

- 0.2-2.5 mm² (IEC) / 26-12 AWG (UL)
- 400 V (IEC) / 300 V (UL)
- 15 A (IEC) / 10 A (UL)

General ordering data

Order No.	Part designation	Version	GTIN (EAN)	Qty.	Packaging
1961360000	BLZP 5.00/10/270LH SN OR BX	PCB plug-in connector, female plug, 5.00 mm, No. of poles: 10, 90°, Clamping yoke connection, Clamping range, max.: 4 mm ² , Box	4032248640638	30 pc(s).	Box
1961590000	BLZP 5.00/10/270LH SN BK BX	PCB plug-in connector, female plug, 5.00 mm, No. of poles: 10, 90°, Clamping yoke connection, Clamping range, max.: 4 mm ² , Box	4032248640867	30 pc(s).	Box

BLZP 5.00/180F SN



Female connectors with clamping yoke screw connection for conductor connection with straight (180°) outlet direction. The female connectors provide space for labelling and can be coded. Can be fastened with flange or release latch. They feature an integrated plus/minus screw, protection against false insertion under clamping yoke. They are delivered with an opened clamping yoke.

- 0.2-2.5 mm² (IEC) / 26-12 AWG (UL)
- 400 V (IEC) / 300 V (UL)
- 19 A (IEC) / 15 A (UL)

General ordering data

Order No.	Part designation	Version	GTIN (EAN)	Qty.	Packaging
1955950000	BLZP 5.00/10/180F SN BK BX	PCB plug-in connector, female plug, 5.00 mm, No. of poles: 10, 180°, Clamping yoke connection, Clamping range, max.: 4 mm ² , Box	4032248634521	36 pc(s).	Box
1955720000	BLZP 5.00/10/180F SN OR BX	PCB plug-in connector, female plug, 5.00 mm, No. of poles: 10, 180°, Clamping yoke connection, Clamping range, max.: 4 mm ² , Box	4032248634255	36 pc(s).	Box

System pitch 5.08 mm (0.200 inch) SL-SMT 5.08/10/90G 3.2SN BK BX

Weidmüller Interface GmbH & Co. KG
 Klingenbergstraße 16
 D-32758 Detmold
 Germany
 Fon: +49 5231 14-0
 Fax: +49 5231 14-2083
 www.weidmueller.com

Counterpart

BLZ 5.08/180F



Female connectors with clamping yoke screw connection for conductor connection with straight outlet direction. The female connectors provide space for labelling and can be coded. Packed in cardboard box.

- 0.20 - 2.5 mm² (IEC) / 26 - 12 AWG (UL)
- 400 V (IEC) / 300 V (UL)
- 19 A (IEC) / 15 A (UL)

General ordering data

Order No.	Part designation	Version	GTIN (EAN)	Qty.	Packaging
1803120000	BLZ 5.08/10/180F SN BK BX	PCB plug-in connector, female plug, 5.08 mm, No. of poles: 10, 180°, Clamping yoke connection, Clamping range, max.: 3.31 mm ² , Box	4032248258222	40 pc(s).	Box
1802910000	BLZ 5.08/10/180F SN OR BX	PCB plug-in connector, female plug, 5.08 mm, No. of poles: 10, 180°, Clamping yoke connection, Clamping range, max.: 3.31 mm ² , Box	4032248257980	40 pc(s).	Box

BLT 5.08F



Female connectors with TOP screw system for connecting conductors with straight 180° outlet direction. The female connectors include space for labelling and can be coded. Packed in cardboard box.

- 0.20 - 2.5 mm² (IEC) / 26 - 14 AWG (UL)
- 400 V (IEC) / 300 V (UL)
- 17 A (IEC) / 10 A (UL)

General ordering data

Order No.	Part designation	Version	GTIN (EAN)	Qty.	Packaging
1844070000	BLT 5.08/10/180F SN OR BX	PCB plug-in connector, female plug, 5.08 mm, No. of poles: 10, 180°, TOP connection, Clamping range, max.: 2.5 mm ² , Box	4032248355990	30 pc(s).	Box
1844300000	BLT 5.08/10/180F SN BK BX	PCB plug-in connector, female plug, 5.08 mm, No. of poles: 10, 180°, TOP connection, Clamping range, max.: 2.5 mm ² , Box	4032248356232	30 pc(s).	Box

System pitch 5.08 mm (0.200 inch) SL-SMT 5.08/10/90G 3.2SN BK BX

Weidmüller Interface GmbH & Co. KG
 Klingenbergstraße 16
 D-32758 Detmold
 Germany
 Fon: +49 5231 14-0
 Fax: +49 5231 14-2083
 www.weidmueller.com

Counterpart

BLL 5.08/90FI



Female connector for PCB mounting. The solder pin length is optimised for wave flow soldering. Packed in cardboard box.

- 400 V (IEC) / 300 V (UL)
- 23 A (IEC) / 15 A (UL)

General ordering data

Order No.	Part designation	Version	GTIN (EAN)	Qty.	Packaging
1843830000	BLL 5.08/10/90FI 3.2SN OR BX	PCB plug-in connector, female header, 5.08 mm, No. of poles: 10, 90°, Solder pin length: 3.2 mm, tinned, Orange, Solder connection, Box	4032248355587	50 pc(s).	Box

BLF 5.08/90LH SN



Just as reliable as the tried-and-true original, with innovation in detail:

The BLF 5.0x – the PUSH-IN version of the BLZ 5.0x socket block – features a new connection system and a more compact design. Weidmüller's innovative PUSH-IN spring connection features a trend-setting, tool-free wire connection system that is simple to operate.

In terms of versatility, the BLF 5.0x offers just as much as the older versions:

- The choice of three wire outlet directions offers you proven design flexibility for your applications.
- Four flange variations, including the patented release latch, allow for user-friendly unplugging designs.

General ordering data

Order No.	Part designation	Version	GTIN (EAN)	Qty.	Packaging
1002560000	BLF 5.08/10/90LH SN OR BX	PCB plug-in connector, female plug, 5.08 mm, No. of poles: 10, 90°, PUSH IN, Clamping range, max.: 3.31 mm², Box	4032248694938	30 pc(s).	Box
1000720001	BLF 5.08/10/90LH SN BK BX	PCB plug-in connector, female plug, 5.08 mm, No. of poles: 10, 90°, PUSH IN, Clamping range, max.: 3.31 mm², Box	4032248690916	30 pc(s).	Box

System pitch 5.08 mm (0.200 inch) SL-SMT 5.08/10/90G 3.2SN BK BX

Weidmüller Interface GmbH & Co. KG
Klingenbergstraße 16
D-32758 Detmold
Germany
Fon: +49 5231 14-0
Fax: +49 5231 14-2083
www.weidmueller.com

Counterpart

BLZP 5.00/180LR SN



Female connectors with clamping yoke screw connection for conductor connection with straight (180°) outlet direction. The female connectors provide space for labelling and can be coded. Can be fastened with flange or release latch. They feature an integrated plus/minus screw, protection against false insertion under clamping yoke. They are delivered with an opened clamping yoke.

- 0.2-2.5 mm² (IEC) / 26-12 AWG (UL)
- 400 V (IEC) / 300 V (UL)
- 19 A (IEC) / 15 A (UL)

General ordering data

Order No.	Part designation	Version	GTIN (EAN)	Qty.	Packaging
1956290000	BLZP 5.00/10/180LR SN OR BX	PCB plug-in connector, female plug, 5.00 mm, No. of poles: 10, 180°, Clamping yoke connection, Clamping range, max.: 4 mm ² , Box	4032248634996	36 pc(s).	Box
1956520000	BLZP 5.00/10/180LR SN BK BX	PCB plug-in connector, female plug, 5.00 mm, No. of poles: 10, 180°, Clamping yoke connection, Clamping range, max.: 4 mm ² , Box	4032248635306	36 pc(s).	Box

BLDT 5.08B



Female connectors with two clamping yoke screw connections per pole for conductor connection with 90° & 270° outlet direction. The female connectors provide space for labelling and can be coded. Packed in cardboard box.

- 0.20 - 2.5 mm² (IEC) / 26 - 12 AWG (UL)
- 400 V (IEC) / 300 V (UL)
- 14 A (IEC) / 10 A (UL)

General ordering data

Order No.	Part designation	Version	GTIN (EAN)	Qty.	Packaging
1673860000	BLDT 5.08/10/-B SN BK BX	PCB plug-in connector, female plug, 5.08 mm, No. of poles: 10, 90°/270°, Clamping yoke connection, Clamping range, max.: 3.31 mm ² , Box	4008190435592	50 pc(s).	Box
1651820000	BLDT 5.08/10/-B SN OR BX	PCB plug-in connector, female plug, 5.08 mm, No. of poles: 10, 90°/270°, Clamping yoke connection, Clamping range, max.: 3.31 mm ² , Box	4008190400507	50 pc(s).	Box