



Chipsmall Limited consists of a professional team with an average of over 10 year of expertise in the distribution of electronic components. Based in Hongkong, we have already established firm and mutual-benefit business relationships with customers from,Europe,America and south Asia,supplying obsolete and hard-to-find components to meet their specific needs.

With the principle of “Quality Parts,Customers Priority,Honest Operation,and Considerate Service”,our business mainly focus on the distribution of electronic components. Line cards we deal with include Microchip,ALPS,ROHM,Xilinx,Pulse,ON,Everlight and Freescale. Main products comprise IC,Modules,Potentiometer,IC Socket,Relay,Connector.Our parts cover such applications as commercial,industrial, and automotives areas.

We are looking forward to setting up business relationship with you and hope to provide you with the best service and solution. Let us make a better world for our industry!



Contact us

Tel: +86-755-8981 8866 Fax: +86-755-8427 6832

Email & Skype: info@chipsmall.com Web: www.chipsmall.com

Address: A1208, Overseas Decoration Building, #122 Zhenhua RD., Futian, Shenzhen, China



REVISIONS			
REV	ECN, ERN NO.	DATE	APPRD.
B	PRODUCT DRAWING (EAR 12992)	DEC13/06	K.L.

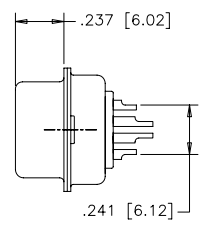
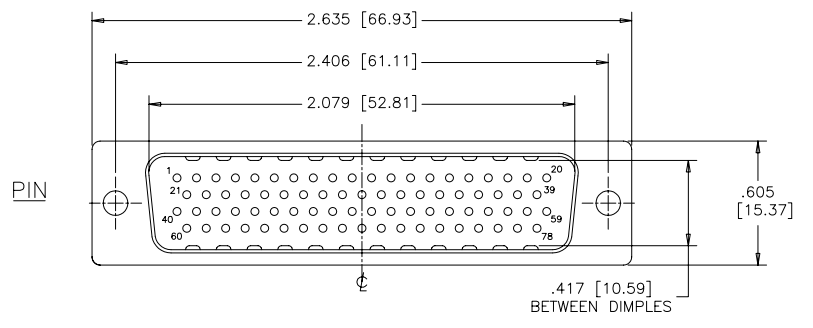

ORDERING CODE:

PART NUMBER: 17EHD-078PAM-100
 SERIES: P
 NUMBER OF CONTACTS: 78
 STYLE: P=PIN, S=SOCKET

TERMINATION-MOUNTING OPTIONS
 000= SOLDER CUP, .120 [3.05] DIA. THROUGH HOLE
 100= SOLDER CUP, #4-40 UNC THREADED HOLES
 200= SOLDER CUP, #4-40 UNC HEX JACK SOCKETS INSTALLED

CONTACT PLATING OPTIONS FOR ENGAGEMENT AREA
 AA= 3μ" [0.08 MICRONS] GOLD FLASH
 CH= 15μ" [0.38 MICRONS] GOLD
 AM= 30μ" [0.76 MICRONS] GOLD

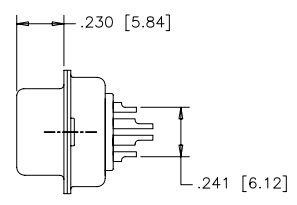
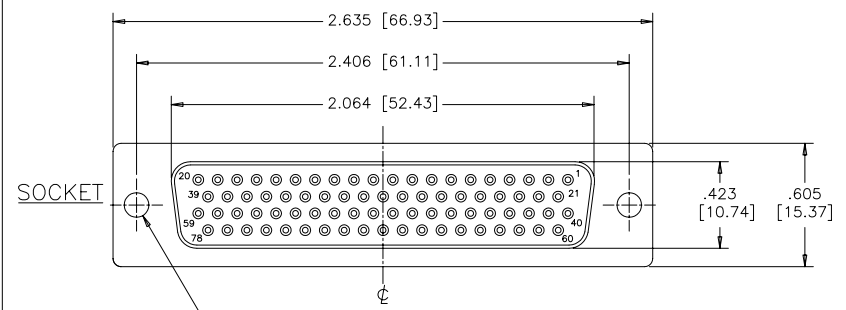

SPECIFICATIONS:

MATERIALS: ALL MATERIALS ARE RoHS COMPLIANT
SHELL: STEEL, TIN PLATED
INSERTS: HIGH TEMPERATURE RESISTANT NYLON, GLASS REINFORCED, UL FLAMMABILITY RATING 94V-0, COLOUR: BLACK
CONTACTS: COPPER ALLOY, GOLD PLATING (SEE ORDERING CODE) OVER 50u" [1.27 MICRONS] NICKEL ON ENGAGEMENT AREA WITH 100u" [2.54 MICRONS] MIN. MATTE TIN ON CONTACT TERMINALS.

TERMINATION-MTG OPTION 000
 SOLDER CUP, .120 [3.05] DIA. THROUGH HOLE (2 PLACES)

ELECTRICAL DATA:

CURRENT RATING: 3 AMP
 CONTACT RESISTANCE: 15 MILLIOHMS MAX.
 INSULATION RESISTANCE: 3000 MEGOHMS MIN.
 DIELECTRIC WITHSTANDING VOLTAGE: 1000 VAC rms
 OPERATING TEMPERATURE: -55°C TO +105°C

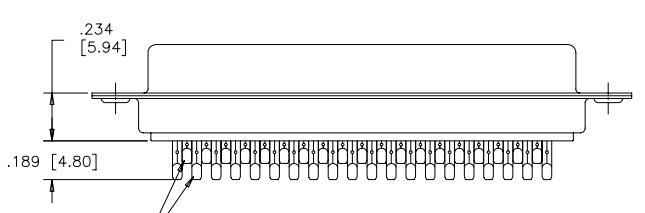

SOLDER CUP WITH .028 [0.71] INSIDE DIAMETER WIRE HOLE

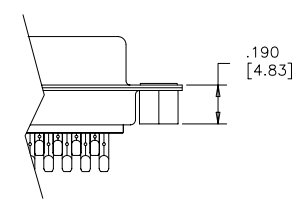

TERMINATION-MTG OPTION 100
 SOLDER CUP, #4-40 UNC THREADED THROUGH HOLES

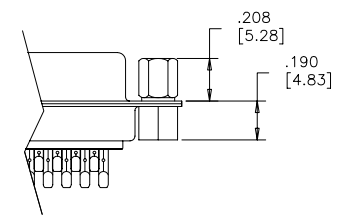

TERMINATION-MTG OPTION 200
 SOLDER CUP, #4-40 UNC HEX JACK SOCKETS INSTALLED

THIS DOCUMENT CONTAINS PROPRIETARY INFORMATION AND SUCH INFORMATION MAY NOT BE DISCLOSED TO OTHERS FOR ANY PURPOSE OR USED FOR MANUFACTURING PURPOSES WITHOUT WRITTEN PERMISSION FROM AMPHENOL CANADA CORP.

DRAWN	J.LEE	DATE	OCT03/06
DESIGNED			
CHECKED	K.LAMBIE	DATE	OCT03/06
I. E. APPRD.			
Q. A. APPRD.			
DWG. APPRD.			
ENG. REL. NO.			
REF.	EAR 12956		
DIMENSIONS ARE IN	CODE ID. NO.		
INCHES	03554		

Amphenol Canada Corp.

TITLE: 17EHD SERIES HIGH DENSITY D-SUB CONNECTOR, 78 SIZE, SOLDER CUP, PLATING & MOUNTING OPTIONS, RoHS COMPLIANT

DWG	DRAWING NO.	REV.
C	P-17EHD-078XXX-X00	B
SCALE	2/1	SHEET 1 OF 1