



Chipsmall Limited consists of a professional team with an average of over 10 year of expertise in the distribution of electronic components. Based in Hongkong, we have already established firm and mutual-benefit business relationships with customers from,Europe,America and south Asia,supplying obsolete and hard-to-find components to meet their specific needs.

With the principle of “Quality Parts,Customers Priority,Honest Operation,and Considerate Service”,our business mainly focus on the distribution of electronic components. Line cards we deal with include Microchip,ALPS,ROHM,Xilinx,Pulse,ON,Everlight and Freescale. Main products comprise IC,Modules,Potentiometer,IC Socket,Relay,Connector.Our parts cover such applications as commercial,industrial, and automotives areas.

We are looking forward to setting up business relationship with you and hope to provide you with the best service and solution. Let us make a better world for our industry!



## Contact us

Tel: +86-755-8981 8866 Fax: +86-755-8427 6832

Email & Skype: info@chipsmall.com Web: www.chipsmall.com

Address: A1208, Overseas Decoration Building, #122 Zhenhua RD., Futian, Shenzhen, China



DESCRIPTION: HIGH DENSITY MALE - SOLDER CUP

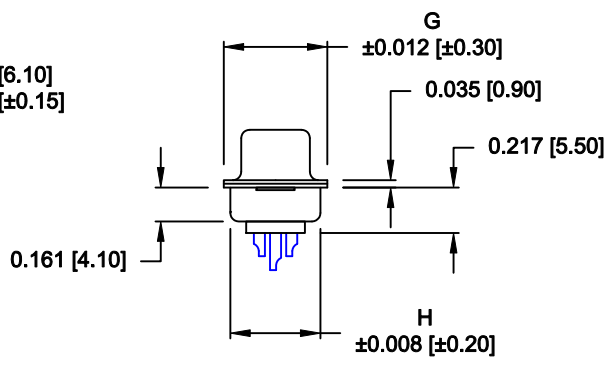
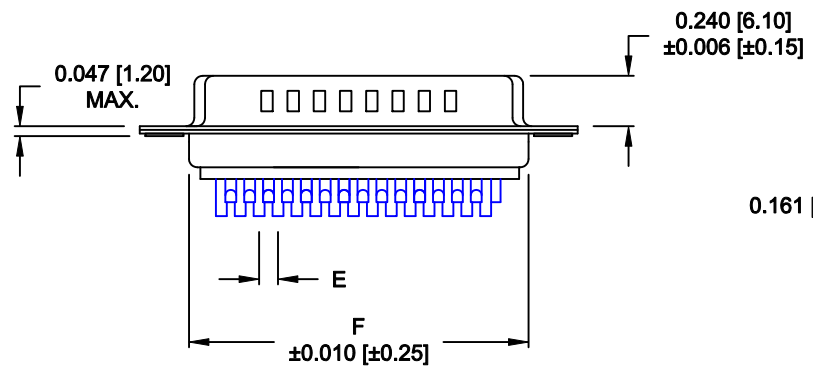
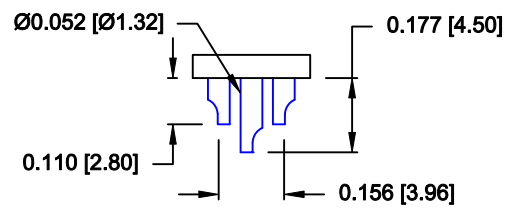
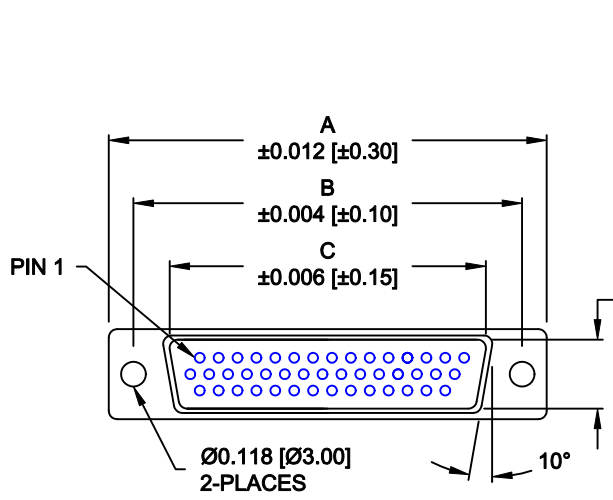

No. OF PINS	DIMENSIONS							
	A	B	C	D	E	F	G	H
15	1.213	0.984	0.666	0.329	0.090	0.756	0.496	0.429
	30.80	24.99	16.92	8.36	2.29	19.20	12.60	10.90
26	1.543	1.312	0.978	0.329	0.090	1.091	0.496	0.429
	39.20	33.32	25.25	8.36	2.29	27.70	12.60	10.90
44	2.087	1.852	1.534	0.329	0.090	1.618	0.496	0.429
	53.00	47.04	38.85	8.36	2.29	41.10	12.60	10.90
62	2.732	2.500	2.181	0.329	0.095	2.256	0.496	0.429
	69.40	63.50	55.40	8.36	2.41	57.30	12.60	10.90
78	2.638	2.406	2.079	0.445	0.095	2.169	0.606	0.526
	67.00	61.10	52.80	11.30	2.41	55.10	15.40	13.35

4 ROWS

180-YYY-10YLYY1

- SERIES \_\_\_\_\_
- POSITIONS \_\_\_\_\_
- 015 \_\_\_\_\_
- 026 \_\_\_\_\_
- 044 \_\_\_\_\_
- 062 \_\_\_\_\_
- 078 \_\_\_\_\_
- GENDER \_\_\_\_\_
- 1 = MALE
- TERMINATION \_\_\_\_\_
- 0 = SOLDER CUP
- SHELL PLATING \_\_\_\_\_
- 2 = TIN
- 3 = NICKEL (GROUND INDENTS)
- RoHS COMPLIANT (230°C) \_\_\_\_\_
- HARDWARE OPTIONS \_\_\_\_\_
- 00 = NO HARDWARE
- 01 = .098" CLINCH NUT (BOARD SIDE)
- 02 = .236" CLINCH NUT (BOARD SIDE)
- 03 = .236" CLINCH NUT (MATING SIDE)
- PLATING OPTIONS \_\_\_\_\_
- 1 = GOLD FLASH
- 2 = 30u" GOLD

**MATERIAL:**

- SHELL: STEEL, TIN OR NICKEL PLATED
- INSULATOR: PBT, UL 94V-O RATED, +30% FIBER-GLASS OR NYLON-66
- CONTACT: BRASS, GOLD PLATED OVER NICKEL

**ELECTRICAL:**

- CURRENT RATING: 5 AMPS
- CONTACT RESISTANCE: 15 mOhms Max.
- INSULATION RESISTANCE: 1,000 MOhms min.
- VOLTAGE: 500VAC FOR 1 MINUTE
- TEMPERATURE: -50° C TO 100° C

NOTE: WILL ACCEPT UP TO 24 AWG WIRE

DO NOT SCALE FROM DRAWING

RoHS COMPLIANT

	THESE DRAWINGS AND SPECIFICATIONS ARE THE PROPERTY OF NorComp AND SHALL NOT BE REPRODUCED, COPIED OR USED AS THE BASIS FOR THE MANUFACTURE OF SALE OF APPARATUS WITHOUT WRITTEN PERMISSION.		DRAWN: <b>WAYNE ROBBINS</b>	DATE: <b>11-29-05</b>
			CHECKED:	DATE:
<b>NorComp</b>		SCALE: <b>1 : 1</b>	SHEET <b>1</b> OF <b>2</b>	REV <b>12</b>
		DWG NO. <b>180-YYY-10YLYY1</b>		

**ALL CLINCH-NUTS ARE 4-40 INTERNAL THREADS**

01X ..... 0.098" (BOARD SIDE) - CN1

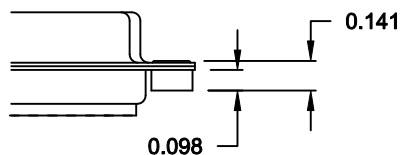

02X ..... 0.236" (BOARD SIDE) - CN2

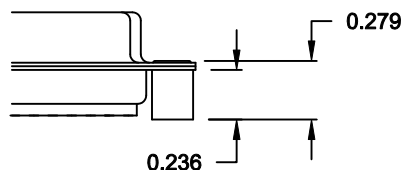

03X..... 0.236" (MATING SIDE) - CN8

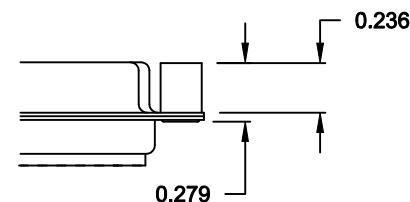

**DO NOT SCALE FROM DRAWING**



THESE DRAWINGS AND SPECIFICATIONS ARE THE PROPERTY OF NorComp AND SHALL NOT BE REPRODUCED, COPIED OR USED AS THE BASIS FOR THE MANUFACTURE OF SALE OF APPARATUS WITHOUT WRITTEN PERMISSION.

DRAWN: **C. SMITH**

DATE: **03-08-06**

CHECKED:

DATE:

**NorComp**

SCALE: **FULL** SHEET **2** OF **2** REV **12**

DWG NO. **180-YYY-10YLYY1**

**RoHS COMPLIANT**