



Chipsmall Limited consists of a professional team with an average of over 10 year of expertise in the distribution of electronic components. Based in Hongkong, we have already established firm and mutual-benefit business relationships with customers from,Europe,America and south Asia,supplying obsolete and hard-to-find components to meet their specific needs.

With the principle of "Quality Parts,Customers Priority,Honest Operation,and Considerate Service",our business mainly focus on the distribution of electronic components. Line cards we deal with include Microchip,ALPS,ROHM,Xilinx,Pulse,ON,Everlight and Freescale. Main products comprise IC,Modules,Potentiometer,IC Socket,Relay,Connector.Our parts cover such applications as commercial,industrial, and automotives areas.

We are looking forward to setting up business relationship with you and hope to provide you with the best service and solution. Let us make a better world for our industry!



Contact us

Tel: +86-755-8981 8866 Fax: +86-755-8427 6832

Email & Skype: info@chipsmall.com Web: www.chipsmall.com

Address: A1208, Overseas Decoration Building, #122 Zhenhua RD., Futian, Shenzhen, China



DESCRIPTION: HIGH DENSITY FEMALE PIN & LOAD

POS.	A	B	C	D	E	F	G
15	1.213	0.984	0.644	0.756	0.311	0.606	0.496
26	1.543	1.312	0.966	1.091	0.311	0.954	0.496
44	2.087	1.852	1.512	1.618	0.311	1.498	0.496
62	2.732	2.500	2.156	2.256	0.311	2.147	0.496
78	2.083	2.406	2.057	2.169	0.429	2.043	0.606

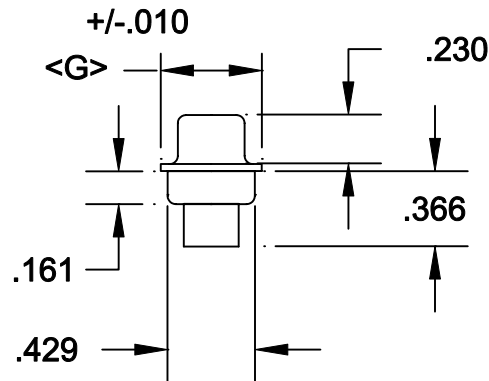
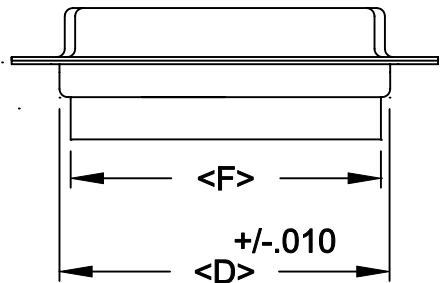
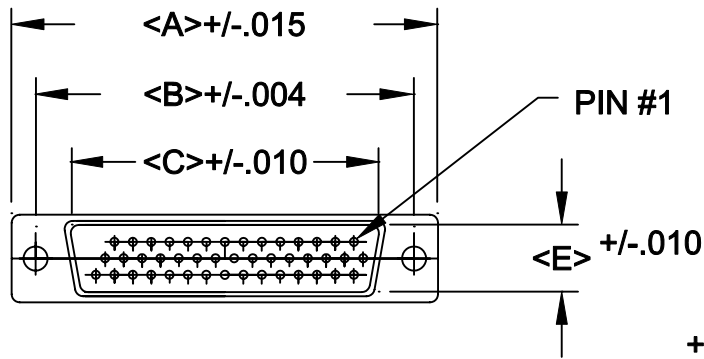

180-XXX-272-XX0

SERIES _____
 POSITIONS _____
 015 _____
 026 _____
 044 _____
 062 _____
 078 _____
 GENDER _____
 1 = MALE
 2 = FEMALE
 TERMINATION _____
 7 = CRIMP/POKE
 SHELL PLATING _____
 2 = TIN
 HARDWARE OPTIONS _____
 00 = NO HARDWARE
 01 = .065 4-40 CLINCH NUT BOARD SIDE
 02 = .250 4-40 CLINCH NUT BOARD SIDE
 03 = .250 4-40 CLINCH NUT MATING SIDE
 91 = .225 4-40 SPACER/BOARD LOCK
 PLATING OPTIONS _____
 0 = NO CONTACTS

SPECIFICATIONS:

MATERIALS:

SHELL: STEEL, TIN PLATED
 INSULATOR: UL 94V-0 RATED BLACK PBT
 +30% FIBER-GLASS OR NYLON-66

ELECTRICALS:

CURRENT RATING: 2 AMPS
 CONTACT RESISTANCE: 15 mOHMS MAX
 INSULATOR RESISTANCE: 1000 MOHMS MIN
 VOLTAGE: 500V AC FOR 1 MINUTE
 TEMPERATURE: -50°C TO +100°C



THESE DRAWINGS AND SPECIFICATIONS ARE THE PROPERTY OF NorComp AND SHALL NOT BE REPRODUCED, COPIED OR USED AS THE BASIS FOR THE MANUFACTURE OR SALE OF APPARATUS WITHOUT WRITTEN PERMISSION.

DRAWN: PAM JENKINS		DATE: 8-12-98
CHECKED:		DATE:
SCALE:	SHEET OF	REV 3
DWG NO. 180-XXX-272-XX0		

NorComp

DESCRIPTION: CLINCH NUT HARDWARE

ALL CLINCH-NUTS ARE 4-40 INTERNAL THREADS

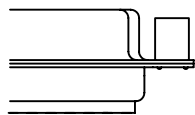

03X..... .250" (MATING SIDE) - CN8

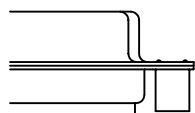

02X250" (BOARD SIDE) - CN2

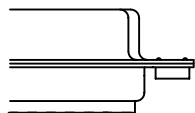

01X098" (BOARD SIDE) - CN1

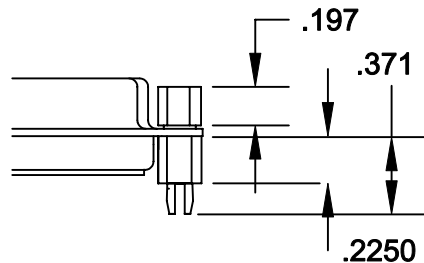

91X225" (BOARD SIDE) - .197 MATING SIDE - CN10/SFS0440

NOTE: 4-40 FEMALE SCREW LOCK IS REMOVABLE

	THESE DRAWINGS AND SPECIFICATIONS ARE THE PROPERTY OF NorComp AND SHALL NOT BE REPRODUCED, COPIED OR USED AS THE BASIS FOR THE MANUFACTURE OF SALE OF APPARATUS WITHOUT WRITTEN PERMISSION.		DRAWN: WAYNE ROBBINS	DATE: 8-23-98
	NorComp		CHECKED: PAM JENKINS	DATE: 8-24-98
SCALE:			SHEET 1 OF 1	REV 1
DWG NO.			CLINCH-NUT OPTIONS	