



Chipsmall Limited consists of a professional team with an average of over 10 year of expertise in the distribution of electronic components. Based in Hongkong, we have already established firm and mutual-benefit business relationships with customers from,Europe,America and south Asia,supplying obsolete and hard-to-find components to meet their specific needs.

With the principle of “Quality Parts,Customers Priority,Honest Operation,and Considerate Service”,our business mainly focus on the distribution of electronic components. Line cards we deal with include Microchip,ALPS,ROHM,Xilinx,Pulse,ON,Everlight and Freescale. Main products comprise IC,Modules,Potentiometer,IC Socket,Relay,Connector.Our parts cover such applications as commercial,industrial, and automotives areas.

We are looking forward to setting up business relationship with you and hope to provide you with the best service and solution. Let us make a better world for our industry!



## Contact us

Tel: +86-755-8981 8866 Fax: +86-755-8427 6832

Email & Skype: info@chipsmall.com Web: www.chipsmall.com

Address: A1208, Overseas Decoration Building, #122 Zhenhua RD., Futian, Shenzhen, China



DESCRIPTION: **HIGH DENSITY MALE SOLDER CUP**

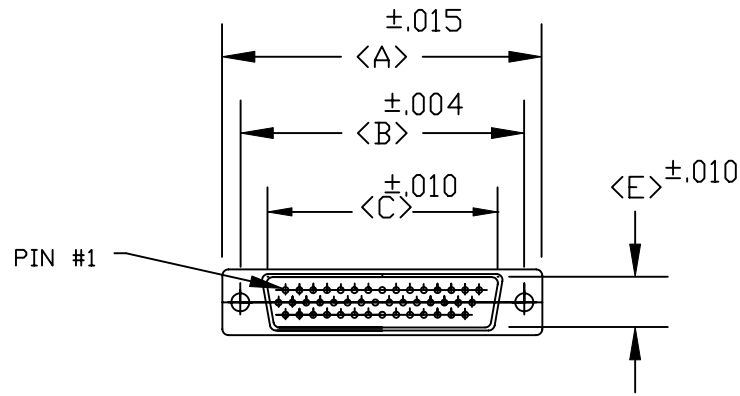

4 ROW

| POS. | A     | B     | C     | D     | E     | F     | G     |
|------|-------|-------|-------|-------|-------|-------|-------|
| 15   | 1.213 | 0.984 | 0.666 | 0.756 | 0.329 | 0.090 | 0.496 |
|      | 30.80 | 24.99 | 16.92 | 19.20 | 8.36  | 2.29  | 12.60 |
| 26   | 1.543 | 1.312 | 0.994 | 1.091 | 0.329 | 0.090 | 0.496 |
|      | 39.19 | 33.32 | 25.25 | 27.70 | 8.36  | 2.29  | 12.60 |
| 44   | 2.087 | 1.852 | 1.534 | 1.618 | 0.329 | 0.090 | 0.496 |
|      | 53.00 | 47.04 | 38.96 | 41.10 | 8.36  | 2.29  | 12.60 |
| 62   | 2.732 | 2.500 | 2.181 | 2.256 | 0.329 | 0.095 | 0.496 |
|      | 69.30 | 63.50 | 55.42 | 57.30 | 8.36  | 2.41  | 12.60 |
| 78   | 2.638 | 2.406 | 2.079 | 2.169 | 0.445 | 0.095 | 0.606 |
|      | 67.00 | 61.00 | 52.80 | 55.10 | 11.30 | 2.41  | 15.39 |

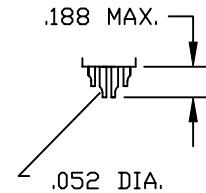
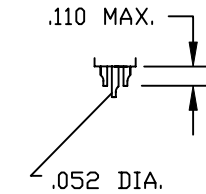
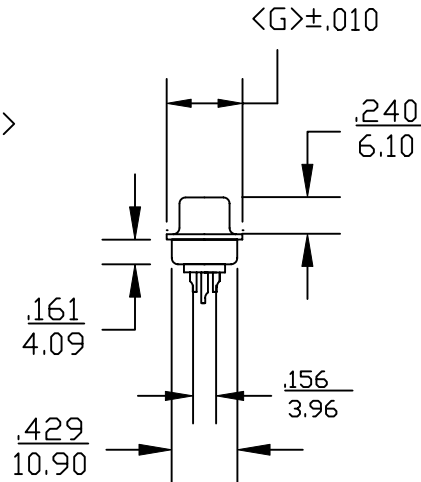
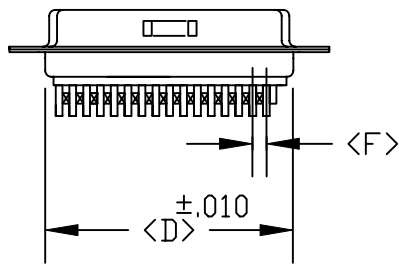

180-XXX-102-XX1

SERIES \_\_\_\_\_  
 POSITIONS \_\_\_\_\_  
 015  
 026  
 044  
 062  
 078  
 GENDER \_\_\_\_\_  
 1 = MALE  
 2 = FEMALE  
 TERMINATION \_\_\_\_\_  
 0 = SOLDER CUP  
 SHELL PLATING \_\_\_\_\_  
 2 = TIN  
 HARDWARE OPTIONS \_\_\_\_\_  
 00 = NO HARDWARE (.120Ø HOLE)  
 01 = 4-40 CLINCH-NUT .098" BOARD SIDE  
 02 = 4-40 CLINCH NUT .250" BOARD SIDE  
 03 = 4-40 CLINCH NUT .250" MATING SIDE  
 91 = 4-40 SPACER/BOARD LOCK .225"  
 PLATING OPTIONS \_\_\_\_\_  
 1 = GOLD FLASH  
 2 = 30 MICRO-INCH GOLD

**ELECTRICALS:**

CURRENT RATING: 2 AMPS  
 CONTACT RESISTANCE: 15 mOHMS MAX.  
 INSULATOR RESISTANCE: 1000MOHMS MIN.  
 VOLTAGE: 500V FOR 1 MINUTE  
 TEMPERATURE: -50° TO +100°

**MATERIALS:**

SHELL: STEEL, TIN PLATED  
 INSULATOR: PBT - BLACK (UL-94-VO)

NOTE: WILL ACCEPT UPTO 24 AWG WIRE

|  |   |  |                              |                         |
|--|---|--|------------------------------|-------------------------|
|  | THESE DRAWINGS AND SPECIFICATIONS ARE THE PROPERTY OF NorComp AND SHALL NOT BE REPRODUCED, COPIED OR USED AS THE BASIS FOR THE MANUFACTURE OR SALE OF APPARATUS WITHOUT WRITTEN PERMISSION. |  | DRAWN:<br><b>PAM JENKINS</b> | DATE:<br><b>8-12-98</b> |
|  |   |  | CHECKED:                     | DATE:                   |
| NorComp  |   |  | SCALE:                       | SHEET OF                |
|  |   |  | DWG NO.                      |                         |
|  |   |  | 180-XXX-102-XX1              |                         |

**DESCRIPTION:** CLINCH NUT HARDWARE

ALL CLINCH-NUTS ARE 4-40 INTERNAL THREADS

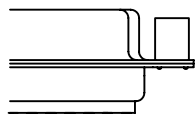

03X..... .250" (MATING SIDE) - CN8

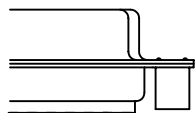

02X ..... .250" (BOARD SIDE) - CN2

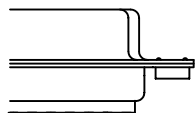

01X ..... .098" (BOARD SIDE) - CN1

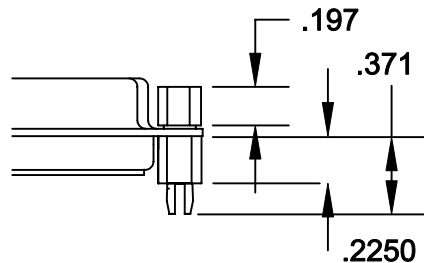

91X ..... .225" (BOARD SIDE) - .197 MATING SIDE - CN10/SFS0440

NOTE: 4-40 FEMALE SCREW LOCK IS REMOVABLE

|  |   |  |                            |                  |
|--|---|--|----------------------------|------------------|
|  | THESE DRAWINGS AND SPECIFICATIONS ARE THE PROPERTY OF NorComp AND SHALL NOT BE REPRODUCED, COPIED OR USED AS THE BASIS FOR THE MANUFACTURE OF SALE OF APPARATUS WITHOUT WRITTEN PERMISSION. |  | DRAWN:<br>WAYNE ROBBINS    | DATE:<br>8-23-98 |
|  | <b>NorComp</b>  |  | CHECKED:<br>PAM JENKINS    | DATE:<br>8-24-98 |
| SCALE:   |   |  | SHEET <b>1</b> OF <b>1</b> | REV <b>1</b>     |
| DWG NO.  |   |  | CLINCH-NUT OPTIONS         |                  |