



Chipsmall Limited consists of a professional team with an average of over 10 year of expertise in the distribution of electronic components. Based in Hongkong, we have already established firm and mutual-benefit business relationships with customers from,Europe,America and south Asia,supplying obsolete and hard-to-find components to meet their specific needs.

With the principle of “Quality Parts,Customers Priority,Honest Operation,and Considerate Service”,our business mainly focus on the distribution of electronic components. Line cards we deal with include Microchip,ALPS,ROHM,Xilinx,Pulse,ON,Everlight and Freescale. Main products comprise IC,Modules,Potentiometer,IC Socket,Relay,Connector.Our parts cover such applications as commercial,industrial, and automotives areas.

We are looking forward to setting up business relationship with you and hope to provide you with the best service and solution. Let us make a better world for our industry!



Contact us

Tel: +86-755-8981 8866 Fax: +86-755-8427 6832

Email & Skype: info@chipsmall.com Web: www.chipsmall.com

Address: A1208, Overseas Decoration Building, #122 Zhenhua RD., Futian, Shenzhen, China



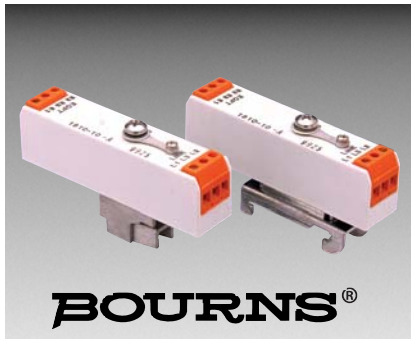

Features

- Low peak clamping voltage even during severe current surges
- Ability to repeatedly protect against surge currents in excess of 10,000 amperes
- Convenient mounting and grounding to any flat surface or to Din 1 (TS-32) or DIN-3 (TS-35) rail
- Cable shields are passed through and may be either grounded or not grounded at the protector
- Vibration-proof screw-type clamp terminals
- Flame-resistant epoxy-filled housing

1800 Series – Signal and Dataline Protector

Bourns® Model 1800 Series Signal and Dataline Protectors are designed to protect sensitive electronic circuits and components from damaging surge voltages and currents. Their extremely fast response and low clamping voltages make them particularly suitable for the protection of signal and data lines associated with computer, data communication, instrumentation, broadcasting and industrial controls. They may be used directly with EIA standard interfaces RS-232, RS-422, RS-423, RS-485 and with 20 mA and 50 mA instrumentation loops. The Model 1800 Series Signal and Dataline Protectors are fast, rugged and capable of protecting against fast rising voltage transients as well as the severe current surges associated with lightning discharges.

Method of Operation

Bourns® Model 1800 Series are heavy-duty, multi-staged protectors. A solid-state section intercepts the leading edge of the surge with sub-nanosecond response time. Within microseconds a 3-pole common chambered gas tube capable of handling 20,000 ampere lightning currents operates and crowbars the surge to ground. The protector remains in the crowbar state until the surge has passed and line voltages return to safe levels, then automatically restores the line to normal operation. There is no need for resetting a breaker or replacing a fuse.

Application

Protectors are generally placed at each end of a signal or data line or current loop. In the case of daisy-chain configurations (such as RS-485), protectors are placed at each node. The 1820 models provide both line-to-ground and line-to-line protection and are designed to use on differential signals (such as RS-422 or RS-485) and 4-20 mA current loops. 1810 models provide line-to-ground protection for two separate circuits and are designed for use on ground referenced signals (such as RS-232) where the return wire is grounded at the protector. The 1811 and 1821 models provide the same protection modes for high frequency applications.

Related Bourns® Protectors

For outdoor applications with 1/2 inch NPT ports (such as field-mounted 4-20 mA transmitters), please refer to Bourns® Model 1669 Series Protector. In this application, the mixed use of a Model 1800 Series Protector at the controller and a Model 1669 Series Protector at the field is recommended.

Characteristics @ 25 °C

Surge Life

>100 operations with 200 Amps..... 10 x 1000 μ sec
 >10 operations with 10,000 Amps..... 8 x 20 μ sec

DC Leakage Current at Rated L/G Voltage <10 μ Amps

Signal/Data Attenuation at Maximum Data Rate 3 db with 600 Ω termination

Operating Temperature..... -40 °C to + 60 °C

Response Time..... 50 pico-seconds

Wire Size 22-14 AWG

INTERFACE OPERATING CHARACTERISTICS			BASE MODEL NUMBER (see below for Clamp designation)	PROTECTIVE CHARACTERISTICS Peak Clamping Voltages				LOAD CURRENT (mA)	TYPICAL CAPACITANCE		SERIES RESISTANCE Each Line L/L (Input to output) (Ohms)
Peak Signal Voltage L/L (Volts)	Max. Data Rate L/G (Volts)	Max. Data Rate (MHz)		@ 5000 Amps, 8x20 μ sec Surge and Voltage Rate-of-Rise of 100 kV / μ sec		@ 1000 Amps, 8x20 μ sec Surge and Voltage Rate-of-Rise of 500 V / μ sec			L/G (pF)	L/L (pF)	
				L/L (Volts)	L/G (Volts)	L/L (Volts)	L/G (Volts)				
20	10	10	1810-10-XX	50	25	42	21	220	2200	1200	10
10	10	4	1820-10-XX	25	25	21	21	220	3300	3300	10
20	10	50	1811-10-XX	60	30	52	26	350	45	45	10
10	10	50	1821-10-XX	30	30	26	26	350	65	65	10
30	15	8	1810-15-XX	70	35	56	28	180	1500	750	15
15	15	3	1820-15-XX	35	35	28	28	180	2300	2300	15
30	15	45	1811-15-XX	80	40	64	32	300	45	45	15
15	15	45	1821-15-XX	40	40	32	32	300	65	65	15
56	28	9	1810-28-XX	110	55	90	45	150	1100	600	22
28	28	4	1820-28-XX	55	55	45	45	150	1800	1800	22
56	28	40	1811-28-XX	120	60	78	78	250	45	45	22
28	28	40	1821-28-XX	60	60	45	45	250	65	65	22
100	50	10	1810-50-XX	178	89	156	156	100	500	300	51
50	50	4	1820-50-XX	89	89	78	78	100	800	800	51

Specifications are subject to change without notice.

The device characteristics and parameters in this data sheet can and do vary in different applications and actual device performance may vary over time. Users should verify actual device performance in their specific applications.

1800 Series – Signal and Dataline Protector

BOURNS®

Typical Connections

Unbalanced Interface, Two Individual Circuits, Such as RS-233

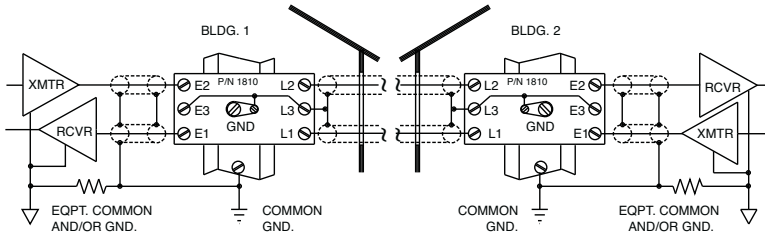

Balanced or Differential Interface, Such as RS-422

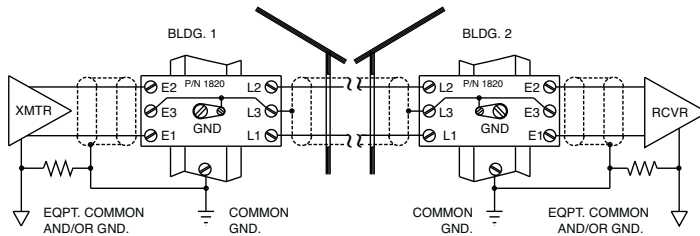

Current Loop, 4-20 mA

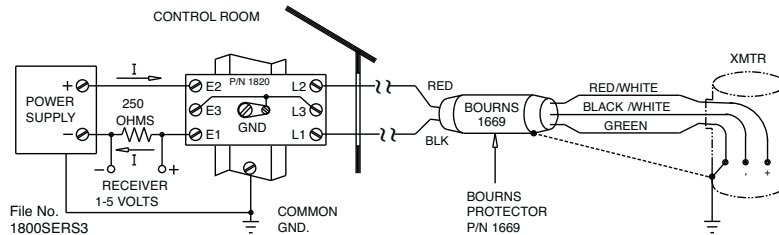

Grounding: The 8-32 mounting screw and attached clamp, and hence the DIN-1 (TS-32) or DIN-3 (TS-35) rail, serve as the protector ground. The rail (or 8-32 mounting screw if the clamp is not used) should be connected to the facility ground via an AWG #6 or larger copper wire. This wire should be as short and straight as possible. Single point grounding will provide better protection and will permit the protector to be located a distance from the equipment.

How To Order (Clamp)

Add -A1 to base model number for DIN-1 clamp.

(Example: 1810-10-A1)

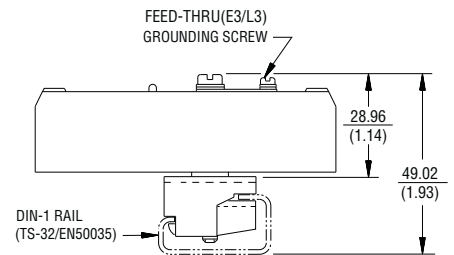

Add -A3 to base model number for DIN-3 clamp.

(Example: 1810-10-A3)

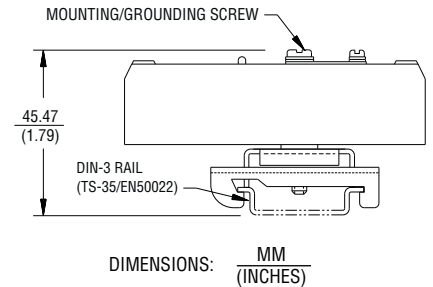

Product Dimensions

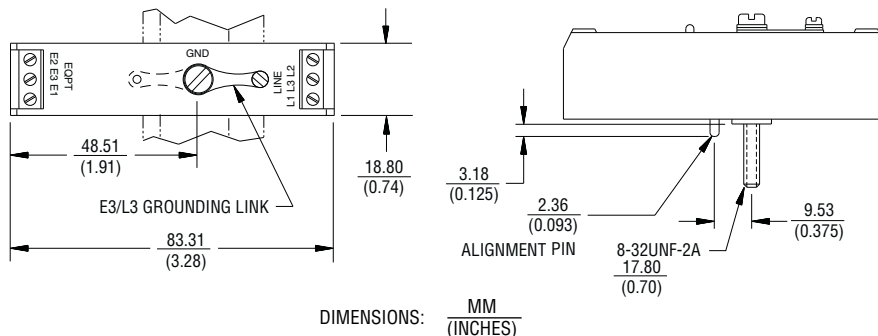

REV. I 01/15

Specifications are subject to change without notice. The device characteristics and parameters in this data sheet can and do vary in different applications and actual device performance may vary over time. Users should verify actual device performance in their specific applications.