



Chipsmall Limited consists of a professional team with an average of over 10 year of expertise in the distribution of electronic components. Based in Hongkong, we have already established firm and mutual-benefit business relationships with customers from,Europe,America and south Asia,supplying obsolete and hard-to-find components to meet their specific needs.

With the principle of "Quality Parts,Customers Priority,Honest Operation,and Considerate Service",our business mainly focus on the distribution of electronic components. Line cards we deal with include Microchip,ALPS,ROHM,Xilinx,Pulse,ON,Everlight and Freescale. Main products comprise IC,Modules,Potentiometer,IC Socket,Relay,Connector.Our parts cover such applications as commercial,industrial, and automotives areas.

We are looking forward to setting up business relationship with you and hope to provide you with the best service and solution. Let us make a better world for our industry!



## Contact us

Tel: +86-755-8981 8866 Fax: +86-755-8427 6832

Email & Skype: info@chipsmall.com Web: www.chipsmall.com

Address: A1208, Overseas Decoration Building, #122 Zhenhua RD., Futian, Shenzhen, China



SW2010

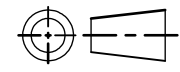

SCALE 1:2

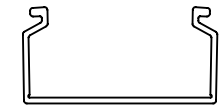

2X1

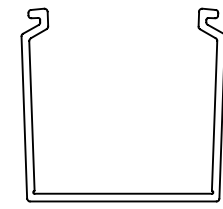

2X2

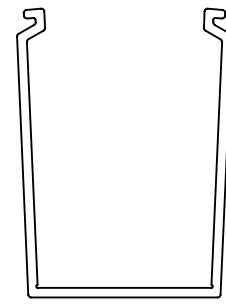

2X3

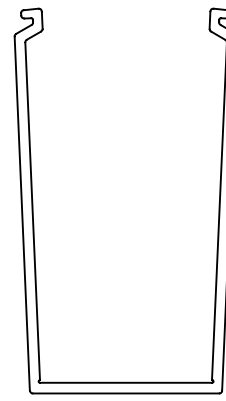

2X4

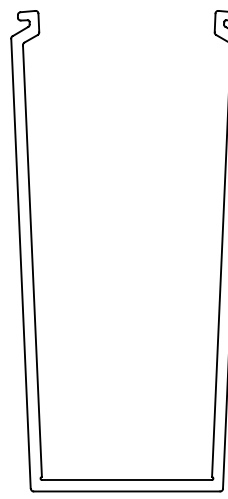

2X5

Revision level		Revision Record	Changed	Date	Approved	Date
Drawing	Part					
06	-	SEE ECN# 100016	MHT	01/06/2012	MHT	02/06/2012

COVER WITH REMOVABLE PROTECTIVE FILM

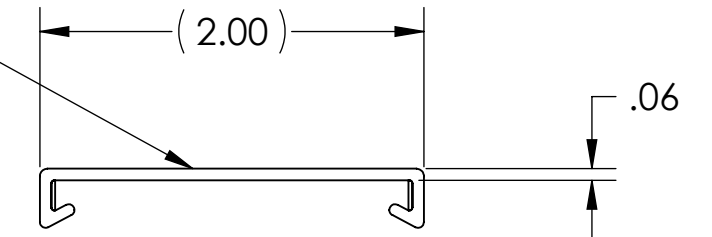

SLOTTED WALL DUCT TYPE "SLHD2X1"

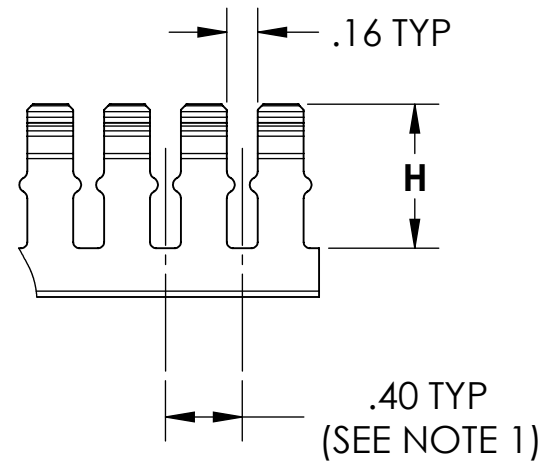

SLOTTED WALL DUCT TYPE "SLHD2X2" "SLHD2X3" "SLHD2X4" "SLHD2X5"

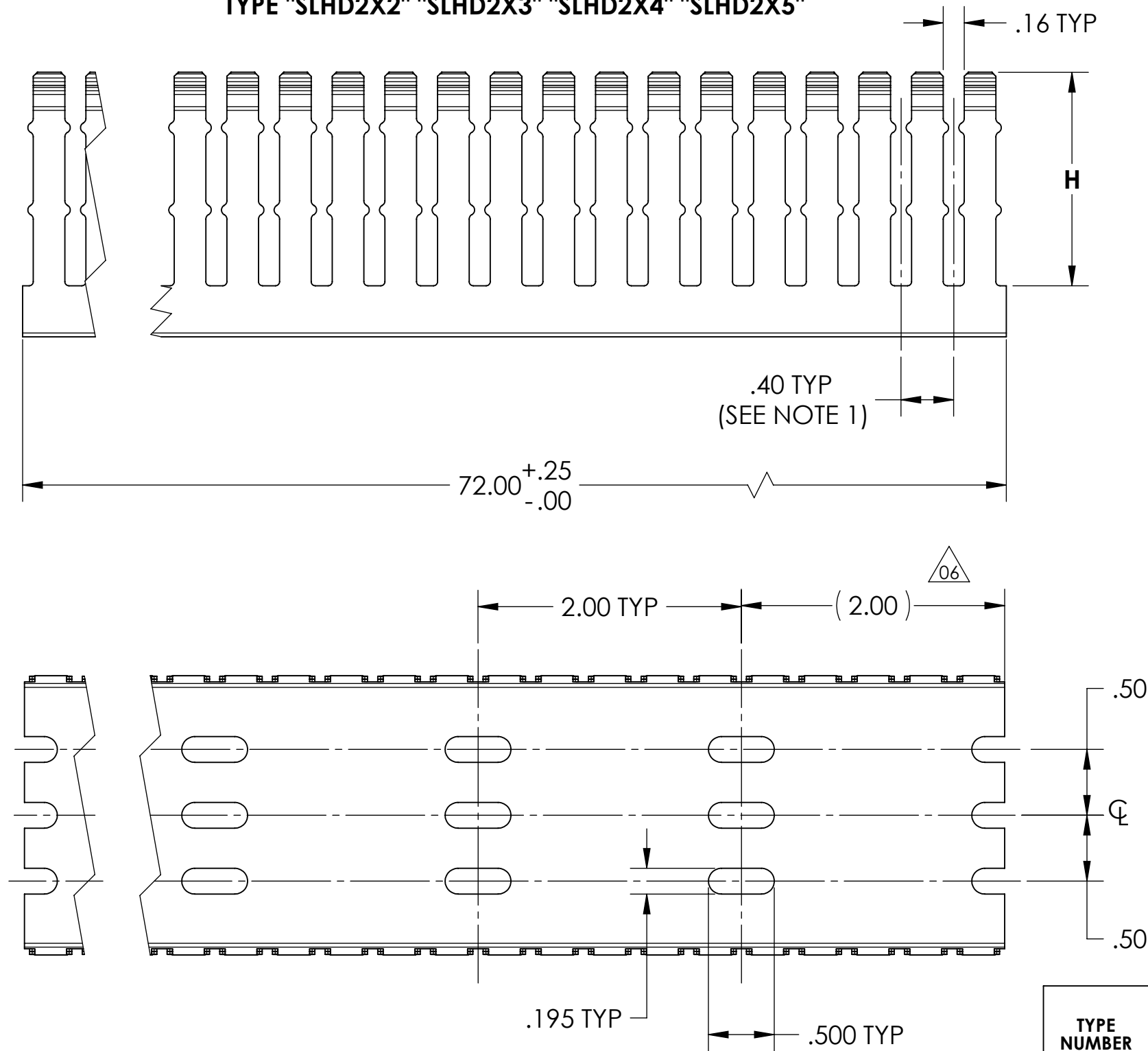

DUCT (2X2 SHOWN)

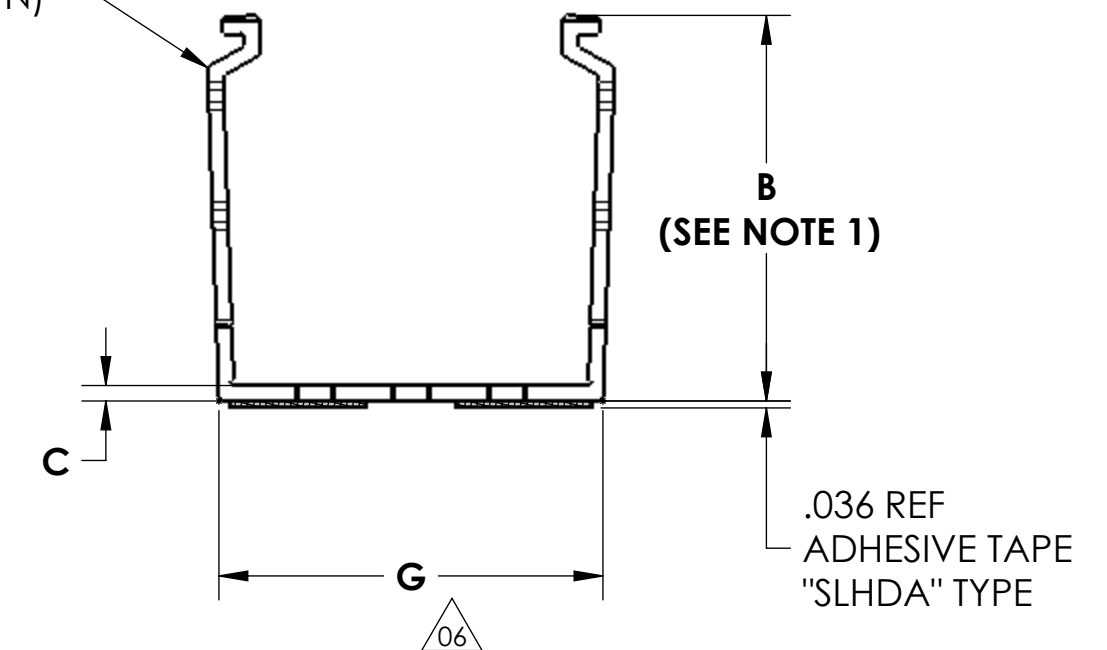

50% WIRE FILL CAPACITY

DUCT SIZE (WxH)	DUCT AREA (Sq. In.)	WIRE O.D.														
		12AWG					14AWG				16AWG					
		12AWG	14AWG	16AWG	18AWG	22AWG	TWISTED PAIR 24 AWG UNSHIELDED									
						4 Pr. Cat 5e	4 Pr. Cat 6	4 Pr. Cat 6a								
		.158	.165	.139	.125	.113	.065	.217	.240	.354						
2X1	1.678	43	39	55	68	84	253	23	19	9						
2X2	3.438	88	80	113	140	171	518	47	38	17						
2X3	5.122	131	120	169	209	255	772	69	57	26						
2X4	6.829	174	160	225	278	341	1030	92	76	35						
2X5	8.488	217	199	280	346	423	1280	115	94	43						

TYPE NUMBER	DESCRIPTION	MOUNTING METHOD	B (SEE NOTE 1)	C	G	H
TC2	COVER	-	-	-	-	-
SLHD2X1	HD SLOTTED DUCT	SCREW	1.004 +.020/-0.015	.060 ± .005	2.000 +/- .025	.750 ± .010
SLHD2X2	"	"	2.008 +.025/-0.020	.080 ± .005	2.000 +/- .025	1.620 ± .015
SLHD2X3	"	"	3.009 +.035/-0.020	.100 ± .007	2.000 +/- .029	2.600 ± .015
SLHD2X4	"	"	4.008 +.045/-0.020	.110 +.008/-0.010	2.000 +/- .031	3.600 ± .015
SLHD2X5	"	"	5.007 +.055/-0.020	.120 +.009/-0.015	2.000 +/- .033	4.600 ± .015
SLHDA2X1	HD SLOTTED DUCT W/ADHES.	ADHESIVE TAPE	1.004 +.020/-0.015	.060 ± .005	2.000 +/- .025	.750 ± .010
SLHDA2X2	"	"	2.008 +.025/-0.020	.080 ± .005	2.000 +/- .025	1.620 ± .015
SLHDA2X3	"	"	3.009 +.035/-0.020	.100 ± .007	2.000 +/- .029	2.600 ± .015
SLHDA2X4	"	"	4.008 +.045/-0.020	.110 +.008/-0.010	2.000 +/- .031	3.600 ± .015
SLHDA2X5	"	"	5.007 +.055/-0.020	.120 +.009/-0.015	2.000 +/- .033	4.600 ± .015

Notes  
1) BOTH SIDES ALIKE WITHIN .015



Material

PVC AVAILABLE IN WHITE, GRAY, BLACK, OR BLUE CONSULT FACTORY FOR OTHER COLORS RoHS COMPLIANT

Units

inches  
Dimension without tolerances details to:  
.xxxx = ±.0005  
.xxx = ±.005  
.xx = ±.01  
.x = ±.03  
None = ±.06  
∠ = ±0.5°

The copyright of this drawing is reserved by HellermannTyton. It is issued on condition that it is not reproduced, copied, or disclosed to a third party, either wholly or in part, without the consent of HellermannTyton.

Drawn: KAC  
Approved: [Signature]  
Date: 06/18/2009  
Article/Type-No: SEE CHART  
Title: 2" WIDE SLHD, SLHDA DUCT WITH COVER  
Drawing-No: DT07-021-203CST  
Pre-Production: Phase  
Scale: 1:1  
Project Number: PRP07-021  
Format: C  
Sheet: 1/1

HellermannTyton  
North America  
Email: corp@htamericas.com  
Web: www.hellermann.tyton.com