



Chipsmall Limited consists of a professional team with an average of over 10 year of expertise in the distribution of electronic components. Based in Hongkong, we have already established firm and mutual-benefit business relationships with customers from,Europe,America and south Asia,supplying obsolete and hard-to-find components to meet their specific needs.

With the principle of “Quality Parts,Customers Priority,Honest Operation,and Considerate Service”,our business mainly focus on the distribution of electronic components. Line cards we deal with include Microchip,ALPS,ROHM,Xilinx,Pulse,ON,Everlight and Freescale. Main products comprise IC,Modules,Potentiometer,IC Socket,Relay,Connector.Our parts cover such applications as commercial,industrial, and automotives areas.

We are looking forward to setting up business relationship with you and hope to provide you with the best service and solution. Let us make a better world for our industry!



Contact us

Tel: +86-755-8981 8866 Fax: +86-755-8427 6832

Email & Skype: info@chipsmall.com Web: www.chipsmall.com

Address: A1208, Overseas Decoration Building, #122 Zhenhua RD., Futian, Shenzhen, China



DFK-MSTBVA 2,5/ 6-GF-5,08

Order No.: 1899320

The figure shows a 10-position version of the product

<http://eshop.phoenixcontact.de/phoenix/treeViewClick.do?UID=1899320>

Header, Nominal current: 12 A, Rated voltage (III/2): 320 V, Number of positions: 6, Pitch: 5.08 mm, Color: green, Metal surface: Sn, Assembly: Soldering

Commercial data

GTIN (EAN)	
sales group	E120
Pack	50 pcs.
Customs tariff	85366990
Catalog page information	Page 287 (CC-2009)

Product notes

WEEE/RoHS-compliant since:
09/20/2005

<http://www.download.phoenixcontact.com>
Please note that the data given here has been taken from the online catalog. For comprehensive information and data, please refer to the user documentation. The General Terms and Conditions of Use apply to Internet downloads.

Technical data

Dimensions / positions

Length	12 mm
Pitch	5.08 mm
Dimension a	25.4 mm
Number of positions	6

Technical data

Range of articles	DFK-MSTBVA 2,5/..-GF
Insulating material group	IIIa
Rated surge voltage (III/3)	4 kV
Rated surge voltage (III/2)	4 kV
Rated surge voltage (II/2)	4 kV
Rated voltage (III/2)	320 V
Rated voltage (II/2)	400 V
Connection in acc. with standard	EN-VDE
Nominal current I_N	12 A
Nominal voltage U_N	250 V
Maximum load current	12 A
Insulating material	PBT
Inflammability class acc. to UL 94	V0

Certificates / Approvals



Certification

CB, CUL, GOST, UL, VDE-PZI

Accessories

Item	Designation	Description
Assembly		
0708263	DFK-MSTB-SS	Screw set, for securing the header to the device wall, consists of an M3 x 10 screw, with a spring washer and a nut
1755477	MSTB-BL	Keying cap, for forming sections, plugs onto header pin, green insulating material

Plug/Adapter

1734401	CR-MSTB	Coding section, inserted into the recess in the header or the inverted plug, red insulating material
---------	---------	--

Additional products

Item	Designation	Description
General		
1873249	FKC 2,5/ 6-STF-5,08	Plug component, Nominal current: 12 A, Rated voltage (III/2): 320 V, Number of positions: 6, Pitch: 5.08 mm, Color: green, Metal surface: Sn
1902343	FKCT 2,5/ 6-STF-5,08	Plug component, Nominal current: 12 A, Rated voltage (III/2): 320 V, Number of positions: 6, Pitch: 5.08 mm, Color: green, Metal surface: Sn
1874141	FKCVR 2,5/ 6-STF-5,08	Plug component, Nominal current: 12 A, Rated voltage (III/2): 320 V, Number of positions: 6, Pitch: 5.08 mm, Color: green, Metal surface: Sn
1873841	FKCVW 2,5/ 6-STF-5,08	Plug component, Nominal current: 12 A, Rated voltage (III/2): 320 V, Number of positions: 6, Pitch: 5.08 mm, Color: green, Metal surface: Sn
1777840	FRONT-MSTB 2,5/ 6-STF-5,08	Plug component, Nominal current: 12 A, Rated voltage (III/2): 320 V, Number of positions: 6, Pitch: 5.08 mm, Color: green, Metal surface: Sn
1778027	MSTB 2,5/ 6-STF-5,08	Plug component, Nominal current: 12 A, Rated voltage (III/2): 320 V, Number of positions: 6, Pitch: 5.08 mm, Color: green, Metal surface: Sn
1809776	MSTBC 2,5/ 6-STZF-5,08	Plug component, Nominal current: 12 A, Rated voltage (III/2): 320 V, Number of positions: 6, Pitch: 5.08 mm, Color: green, Metal surface: Sn, Corresponding female crimp contacts with current [A] and conductor cross section range [mm ²] data: 10A/MSTBC-MT 0,5-1,0 (3190564); 10A/MSTBC-MT 0,5-1,0 BA (3190645); 12A/MSTBC-MT 1,5-2,5 (3190551); 12A/MSTBC-MT 1,5-2,5 BA (3190658). BA = Bandkontakte
1805343	MSTBT 2,5/ 6-STF-5,08	Plug component, Nominal current: 12 A, Rated voltage (III/2): 320 V, Number of positions: 6, Pitch: 5.08 mm, Color: green, Metal surface: Sn
1835135	MVSTBR 2,5/ 6-STF-5,08	Plug component, Nominal current: 12 A, Rated voltage (III/2): 320 V, Number of positions: 6, Pitch: 5.08 mm, Color: green, Metal surface: Sn
1834945	MVSTBW 2,5/ 6-STF-5,08	Plug component, Nominal current: 12 A, Rated voltage (III/2): 320 V, Number of positions: 6, Pitch: 5.08 mm, Color: green, Metal surface: Sn
1883394	QC 1/ 6-STF-5,08	Plug component, Nominal current: 10 A, Rated voltage (III/2): 630 V, Number of positions: 6, Pitch: 5.08 mm, Color: green, Metal surface: Sn
1853146	TMSTBP 2,5/ 6-STF-5,08	Plug component, Nominal current: 12 A, Rated voltage (III/2): 320 V, Number of positions: 6, Pitch: 5.08 mm, Color: green, Metal surface: Sn, The plug allows conductors to be looped through from module to module.

Diagrams/Drawings

Drilling plan/solder pad geometry

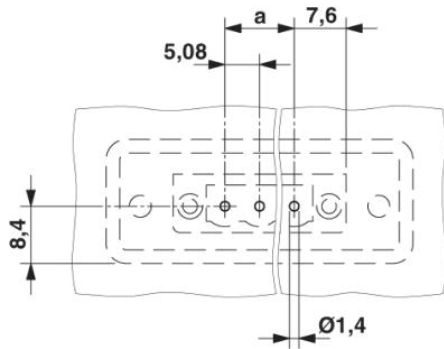

Dimensioned drawing

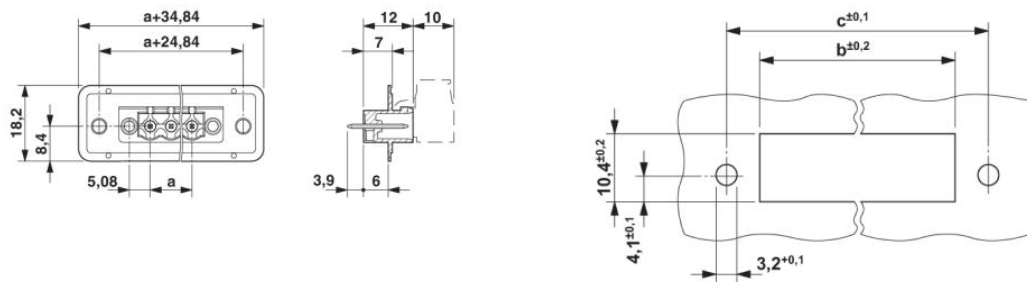

Dimension b = 10.49 mm + (no. of pos. x 5.08 mm)
Dimension c = Dim. b + 9.27 mm

Address

PHOENIX CONTACT Deutschland GmbH
Flachmarktstr. 8
32825 Blomberg, Germany
Phone +49 5235 3 12000
Fax +49 5235 3 41200
<http://www.phoenixcontact.de>



© 2010 Phoenix Contact
Technical modifications reserved;