



Chipsmall Limited consists of a professional team with an average of over 10 year of expertise in the distribution of electronic components. Based in Hongkong, we have already established firm and mutual-benefit business relationships with customers from,Europe,America and south Asia,supplying obsolete and hard-to-find components to meet their specific needs.

With the principle of “Quality Parts,Customers Priority,Honest Operation,and Considerate Service”,our business mainly focus on the distribution of electronic components. Line cards we deal with include Microchip,ALPS,ROHM,Xilinx,Pulse,ON,Everlight and Freescale. Main products comprise IC,Modules,Potentiometer,IC Socket,Relay,Connector.Our parts cover such applications as commercial,industrial, and automotives areas.

We are looking forward to setting up business relationship with you and hope to provide you with the best service and solution. Let us make a better world for our industry!



## Contact us

Tel: +86-755-8981 8866 Fax: +86-755-8427 6832

Email & Skype: info@chipsmall.com Web: www.chipsmall.com

Address: A1208, Overseas Decoration Building, #122 Zhenhua RD., Futian, Shenzhen, China



## EMCV 1,5/ 4-G-3,5

Order No.: 1911033

The figure shows a 10-position version of the product

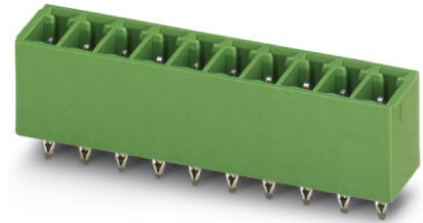
<http://eshop.phoenixcontact.de/phoenix/treeViewClick.do?UID=1911033>

Header, Nominal current: 8 A, Rated voltage (III/2): 160 V, Number of positions: 4, Pitch: 3.5 mm, Color: green, Metal surface: Sn, Assembly: Press-in

### Commercial data

GTIN (EAN)	 4 017918 175788
sales group	E105
Pack	50 pcs.
Customs tariff	85366990
Catalog page information	Page 173 (CC-2009)

### Product notes

WEEE/RoHS-compliant since:  
01/01/2003



<http://www.download.phoenixcontact.com>  
Please note that the data given here has been taken from the online catalog. For comprehensive information and data, please refer to the user documentation. The General Terms and Conditions of Use apply to Internet downloads.

### Technical data

#### Dimensions / positions

Length	7.25 mm
Pitch	3.5 mm
Dimension a	10.5 mm
Number of positions	4

Pin dimensions	0,8 x 0,8 mm
Hole diameter	1.45 mm

**Technical data**

Range of articles	EMCV 1,5/...-G
Insulating material group	IIIa
Rated surge voltage (III/3)	2.5 kV
Rated surge voltage (III/2)	2.5 kV
Rated surge voltage (II/2)	2.5 kV
Rated voltage (III/2)	160 V
Rated voltage (II/2)	250 V
Connection in acc. with standard	EN-VDE
Nominal current $I_N$	8 A
Nominal voltage $U_N$	160 V
Maximum load current	8 A
Insulating material	PBT
Inflammability class acc. to UL 94	V0
Nominal voltage, UL/CUL Use Group B	300 V
Nominal current, UL/CUL Use Group B	8 A
Nominal voltage, UL/CUL Use Group D	300 V
Nominal current, UL/CUL Use Group D	8 A

**Certificates / Approvals**



Certification

CUL, GOST, UL

**Accessories**

Item	Designation	Description
------	-------------	-------------

**Assembly**

1877258	EMC 1,5-SH	Stamp holder, for upper and lower stamp
1877274	EMCV 1,5-SS 1	Stamp set, consisting of upper and lower stamp for 3.81 mm pitch, 2 to 16-pos.

---

**Marking**

0804073	SK 3,5/2,8:FORTL.ZAHLEN	Marker card, printed horizontally, self-adhesive, 10-section marker strip, 14 identical decades marked 1-10, 11-20 etc. up to 91-100, sufficient for 140 terminal blocks
---------	-------------------------	--

**Plug/Adapter**

1734634	CP-MSTB	Keying profile, is inserted into the slot on the plug or inverted header, red insulating material
---------	---------	---

**Additional products**

Item	Designation	Description
<b>General</b>		
1840382	MC 1,5/ 4-ST-3,5	Plug component, Nominal current: 8 A, Rated voltage (III/2): 160 V, Number of positions: 4, Pitch: 3.5 mm, Color: green, Metal surface: Sn
1863178	MCVR 1,5/ 4-ST-3,5	Plug component, Nominal current: 8 A, Rated voltage (III/2): 160 V, Number of positions: 4, Pitch: 3.5 mm, Color: green, Metal surface: Sn
1862878	MCVW 1,5/ 4-ST-3,5	Plug component, Nominal current: 8 A, Rated voltage (III/2): 160 V, Number of positions: 4, Pitch: 3.5 mm, Color: green, Metal surface: Sn

**Diagrams/Drawings**

Drilling plan/solder pad geometry

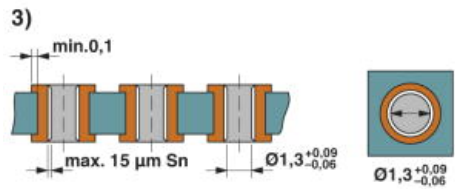
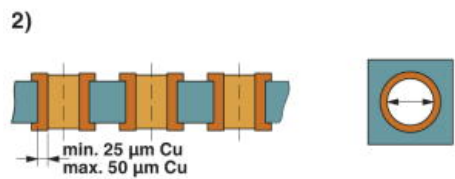
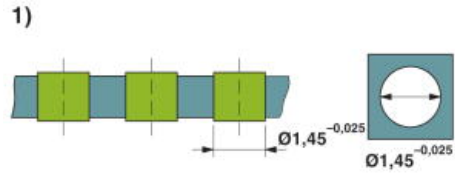
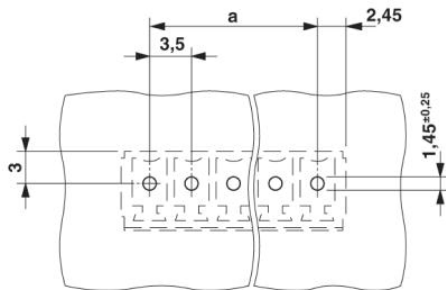

Drill hole layout in FR4 or EP-GC basic material

Dimensioned drawing

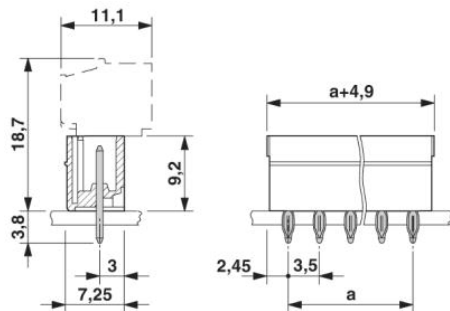

**Address**

PHOENIX CONTACT Deutschland GmbH  
Flachmarktstr. 8  
32825 Blomberg, Germany  
Phone +49 5235 3 12000  
Fax +49 5235 3 41200  
<http://www.phoenixcontact.de>



© 2010 Phoenix Contact  
Technical modifications reserved;