



Chipsmall Limited consists of a professional team with an average of over 10 year of expertise in the distribution of electronic components. Based in Hongkong, we have already established firm and mutual-benefit business relationships with customers from,Europe,America and south Asia,supplying obsolete and hard-to-find components to meet their specific needs.

With the principle of “Quality Parts,Customers Priority,Honest Operation,and Considerate Service”,our business mainly focus on the distribution of electronic components. Line cards we deal with include Microchip,ALPS,ROHM,Xilinx,Pulse,ON,Everlight and Freescale. Main products comprise IC,Modules,Potentiometer,IC Socket,Relay,Connector.Our parts cover such applications as commercial,industrial, and automotives areas.

We are looking forward to setting up business relationship with you and hope to provide you with the best service and solution. Let us make a better world for our industry!



Contact us

Tel: +86-755-8981 8866 Fax: +86-755-8427 6832

Email & Skype: info@chipsmall.com Web: www.chipsmall.com

Address: A1208, Overseas Decoration Building, #122 Zhenhua RD., Futian, Shenzhen, China





Pushing Performance

HARTING Han-Eco[®] Series



Transforming customer wishes into concrete solutions



The HARTING Technology Group is skilled in the fields of electrical, electronic and optical connection, transmission and networking, as well as in manufacturing, mechatronics and software creation. The Group uses these skills to develop customized solutions and products such as connectors for energy and data transmission applications including, for example, mechanical engineering, rail technology, wind energy plants, factory automation and the telecommunications sector. In addition, HARTING also produces electro-magnetic components for the automobile industry and offers solutions in the field of Enclosures and Shop Systems. The HARTING Group currently comprises 32 subsidiary companies and worldwide distributors employing a total of approximately 3,000 staff.



We aspire to top performance.

Connectors ensure functionality. As core elements of electrical and optical wiring, connection and infrastructure technologies, they are essential in enabling the modular construction of devices, machines and systems across a very wide range of industrial applications. Their reliability is a crucial factor guaranteeing smooth functioning in the manufacturing area, in telecommunications, applications in medical technology – in fact, connectors are at work in virtually every conceivable application area. Thanks to the consistent further development of our technologies, customers enjoy investment security and benefit from durable, long term functionality.

Always at hand, wherever our customers may be.

Increasing industrialization is creating growing markets characterized by widely diverging demands and requirements. The search for perfection, increasingly efficient processes and reliable technologies is a common factor in all sectors across the globe.

HARTING is providing these technologies – in Europe, America and Asia. The **HARTING** professionals at our international subsidiaries engage in close, partnership based interaction with our customers, right from the very early product development phases, in order to realize customer demands and requirements in the best possible manner.

Our people on location form the interface to the centrally coordinated development and production departments. In this way, our customers can rely on consistently high, superior product quality – worldwide.

Our claim: pushing performance.

HARTING provides more than optimally attuned components. In order to serve our customers with the best possible solutions, **HARTING** is able to contribute a great deal more and play a closely integrative role in the value creation process.

From ready assembled cables through to control racks or ready-to-go control desks: Our aim is to generate the maximum benefits for our customers – without compromise!

Quality creates reliability – and warrants trust.

The **HARTING** brand stands for superior quality and reliability – worldwide. The standards we set are the result of consistent, stringent quality management that is subject to regular certifications and audits.

EN ISO 9001, the EU Eco-Audit and ISO 14001:2004 are key elements here. We take a proactive stance to new requirements, which is why **HARTING** ranks among the first companies worldwide to have obtained the new IRIS quality certificate for rail vehicles.



HARTING technology creates added value for customers. Technologies by HARTING are at work worldwide. HARTING's presence stands for smoothly functioning systems, powered by intelligent connectors, smart infrastructure solutions and mature network systems. In the course of many years of close, trust-based cooperation with its customers, the HARTING Technology Group has advanced to one of the worldwide leading specialists for connector technology. Extending beyond the basic functionalities demanded, we offer individual customers specific and innovative solutions. These tailored solutions deliver sustained effects, provide investment security and enable customers to achieve strong added value.

Opting for HARTING opens up an innovative, complex world of concepts and ideas.

In order to develop connectivity and network solutions serving an exceptionally wide range of connector applications and task scopes in a professional and cost optimized manner, HARTING not only commands the full array of conventional tools and basic technologies. Over and beyond these capabilities, HARTING is constantly harnessing and refining its broad base of knowledge and experience to create new solutions that ensure continuity at the same time. In securing this know-how lead, HARTING draws on a wealth of sources from both in-house research and the world of applications alike. Salient examples of these sources of innovative knowledge include microstructure technologies, 3D design and construction technology, as well as high temperature

or ultrahigh frequency applications that are finding use in telecommunications or automation networks, in the automotive industry, or in industrial sensor and actuator applications, RFID and wireless technologies, in addition to packaging and housing made of plastics, aluminum or stainless steel.

HARTING solutions extend across technology boundaries.

Drawing on the comprehensive resources of the group's technology pool, HARTING devises practical solutions for its customers. Whether this involves industrial networks for manufacturing automation, or hybrid interface solutions for wireless telecommunication infrastructures, 3D circuit carriers with microstructures, or cable assemblies for high-temperature applications in the automotive industry – HARTING technologies offer far more than components, and represent mature, comprehensive solutions attuned to individual customer requirements and wishes. The range covers ready-to-use cable configurations, completely assembled backplanes and board system carriers, as well as fully wired and tested control panels.

In order to ensure the future proof design of RF- and EMC-compatible interface solutions, the central HARTING laboratory (certified to EN 45001) provides simulation tools, as well as experimental, testing and diagnostics facilities all the way through to scanning electron microscopes. In the selection of materials and processes, lifecycle and environmental aspects play a key role, in addition to product and process capability considerations.



HARTING knowledge is practical know-how generating synergy effects.

HARTING commands decades of experience with regard to the applications conditions of connectors in telecommunications, computer and network technologies and medical technologies, as well as industrial automation technologies, such as the mechanical engineering and plant engineering areas, in addition to the power generation industry or the transportation sector. **HARTING** is highly conversant with the specific application areas in all of these technology fields.

The key focus is on applications in every solution approach. In this context, uncompromising, superior quality is our hallmark. Every new solution found will invariably flow back into the **HARTING** technology pool, thereby enriching our resources. And every new solution we go on to create will draw on this wealth of resources in order to optimize each and every individual solution. In this way, **HARTING** is synergy in action.

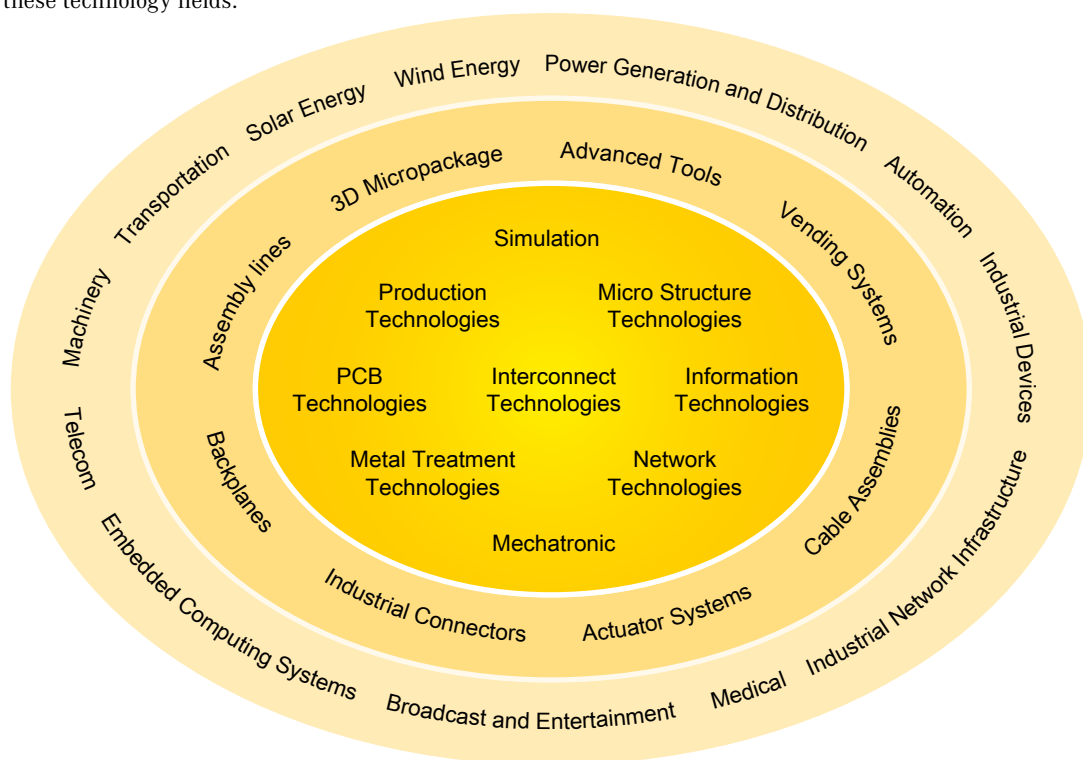

Automation IT

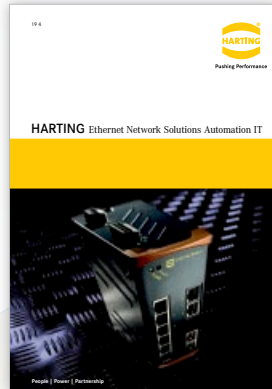

ETHERNET NETWORK SOLUTIONS

The Automation IT catalogue offers a consistent range of Ethernet network components and cabling products, which form the communication platform of convergent Automation IT

networks. The performance of network components opens up access to a wide range of applications for industrial buildings, manufacturing plants and machines in industrial environments.

Installation Connectivity

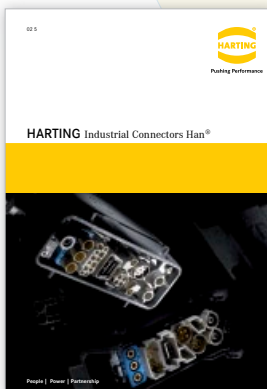

INDUSTRIAL CONNECTORS Han®

This catalogue documents the worldwide standard for industrial connectors. Han® connectors represent the preferential solution in the cable-to-cable interconnection of data, signal and power applications operating under the most

demanding conditions and meeting stringent requirements with regard to safe and detachable electrical connections with high degree of protection IP 65 / IP 67. Installations making use of Han® connectors impress with their rugged design, convenient handling and modularity of data, signal and power connections. Han® connectors represent the worldwide standard in industry, railway technology, as well as in power generation and distribution.

Device Connectivity

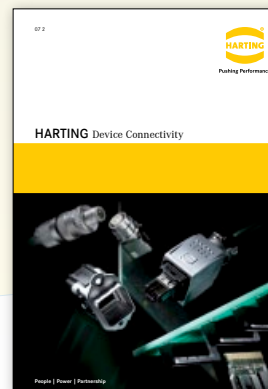

DEVICE CONNECTIVITY

The DeviceCon catalogue provides a universal, innovative product portfolio of PCB connections and of termination technology. The product range comprises board-to-board and cable-to-board connectors for industrial

electronic devices with degree of protection IP 20 to IP 65 / IP 67. These HARTING solutions offer appropriate device connectivity for a wide range of devices, ranging from sensors to industrial computers and their respective data, signal and power interfaces.

Contents

Page

Description of the Han-Eco® system	8
Technical characteristics Han-Eco® Hoods/Housings	9
Han-Eco® Hoods/Housings 6 B	10
Han-Eco® Hoods/Housings 10 B	11
Han-Eco® Hoods/Housings 16 B	12
Han-Eco® Hoods/Housings 24 B	13
Han-Eco® Accessories	14
Summary Han-Modular®	15

Description of the Han-Eco® system



Han-Eco® – a new hood and housing series made of thermoplastic material.

Han-Eco® is the ideal solution for applications that do not require the full range of product features offered by the Han® B series of hoods and housings, and users want to take advantage of the weight and cost advantages.

Like the Han® B standard series, the Han-Eco® series is available in the following sizes: 6 B, 10 B, 16 B and 24 B. Depending on size, versions of the hoods with straight or angled entries and housings, bulkhead mounting, can be supplied. The cable exits are available with metric threading, a cable gland is implemented. For housing sizes 6 B and 10 B size of the cable gland is M32, for 16 B and 24 B cable gland M40 is used.

Han-Eco® hoods and housings are made of high-performance plastic that is highly resistant to environmental stress and – in combination with the design - provides very good mechanical stability. When the connector is closed and locked, it provides degree of protection IP 65 as defined in DIN EN 60 529. The material also meets demanding flammability requirements of UL 94 Class V 0.

Fast, simple assembly is another outstanding product feature. Click-and-mate design totally eliminates the need for tools during assembly of the Han-Eco® hoods and housings.

The Han-Eco® hoods and housings is compatible with the range of modules from the Han-Modular® series. One extra module fits into the Han-Eco® hoods and housing compared to the equivalent product in the Han® B Standard series. This special feature applies to all four sizes.

A optional PE module has been developed specifically for the Han-Eco® hoods and housings to hold the protective ground conductor.

Advantages:

- Weight reduction combined with mechanical strength
- Fast assembly process without tools
- Highly resistant to environmental stress, suitable for use in outdoor applications
- Complete range of modules from Han-Modular® series usable

Assembly details

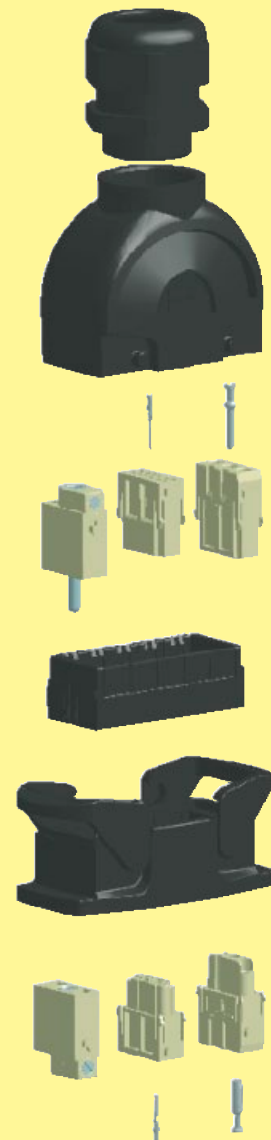

Features

- Available in sizes 6 B, 10 B, 16 B and 24 B including integrated cable glands
- Capable for applications according protection class II
- Same panel cut out as Han® B housings, bulkhead mounting
- Optional PE contact module for hold the protective ground conductor
- Not mating compatible with series Han® B
- New hoods/housings series made of thermoplastic material with excellent mechanical properties and high resistance against environmental influence
- Weight and cost optimised
- Quick assembly without screws and tools („click and mate“)
- One extra module fits into the Han-Eco® hoods/housings compared to equivalent size of Han® B series



Technical characteristics

Specifications	DIN EN 61 984
----------------	---------------

Hoods/Housings

Material	
- Hoods/Housings	Polyamide, fibre-glass reinforced
- Locking element	Polyamide, fibre-glass reinforced
- Hoods/Housings seal	NBR
Limiting temperatures	-40 °C ... +125 °C
Flammability acc. to UL 94	V 0
Degree of protection acc. to DIN EN 60 529 for coupled connector	IP 65

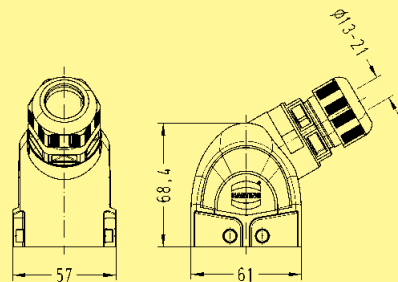
Plastic hoods/housings for industrial applications / 2 lever locking system

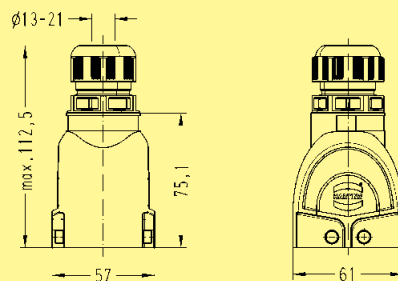
Identification	Part number	Cable entry	Drawing	Dimensions in mm
Hood with integrated cable gland side entry 	19 41 106 0522	M32		
Hood with integrated cable gland top entry 	19 41 106 0422	M32		

Plastic hoods/housings for industrial applications / 2 lever locking system

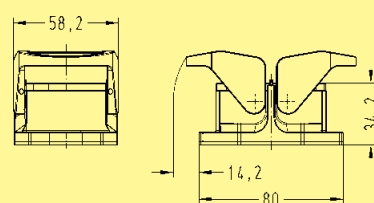
Identification	Part number	Cable entry	Drawing	Dimensions in mm
Housings, bulkhead mounting 	19 41 006 0301			

PE contact modules

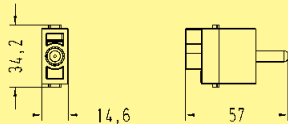
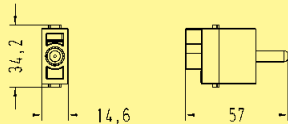
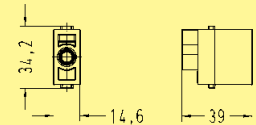
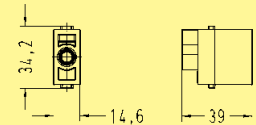
Identification	Part number	Drawing	Dimensions in mm
Han-Eco® PE contact module with screw terminal Termination wire gauge 1.5 mm² ... 16 mm² Male insert 	19 41 001 2600		
Female insert 	19 41 001 2700		

Plastic hoods/housings for industrial applications / 2 lever locking system

Identification	Part number	Cable entry	Drawing	Dimensions in mm
Hood with integrated cable gland side entry	19 41 110 0522	M32		
Hood with integrated cable gland top entry	19 41 110 0422	M32		

Plastic hoods/housings for industrial applications / 2 lever locking system

Identification	Part number	Cable entry	Drawing	Dimensions in mm
Housings, bulkhead mounting	19 41 010 0301			

PE contact modules

Identification	Part number	Drawing	Dimensions in mm
Han-Eco® PE contact module with screw terminal Termination wire gauge 1.5 mm² ... 16 mm²			
Male insert	19 41 001 2600		
Female insert	19 41 001 2700		

Plastic hoods/housings for industrial applications / 2 lever locking system

Identification	Part number	Cable entry	Drawing	Dimensions in mm
Hood with integrated cable gland side entry	19 41 116 0523	M40		
Hood with integrated cable gland top entry	19 41 116 0423	M40		

Plastic hoods/housings for industrial applications / 2 lever locking system

Identification	Part number	Cable entry	Drawing	Dimensions in mm
Housings, bulkhead mounting	19 41 016 0301			

PE contact modules

Identification	Part number	Drawing	Dimensions in mm
Han-Eco® PE contact module with screw terminal Termination wire gauge 1.5 mm² ... 16 mm²			
Male insert	19 41 001 2600		
Female insert	19 41 001 2700		

Plastic hoods/housings for industrial applications / 2 lever locking system

Identification	Part number	Cable entry	Drawing	Dimensions in mm
Hood with integrated cable gland side entry	19 41 124 0523	M40		
Hood with integrated cable gland top entry	19 41 124 0423	M40		

Plastic hoods/housings for industrial applications / 2 lever locking system















Identification	Part number	Cable entry	Drawing	Dimensions in mm
Housings, bulkhead mounting	19 41 024 0301			





PE contact modules

Identification	Part number	Drawing	Dimensions in mm
Han-Eco® PE contact module with screw terminal Termination wire gauge 1.5 mm² ... 16 mm²			
Male insert	19 41 001 2600		
Female insert	19 41 001 2700		

Identification	Part number	Drawing	Dimensions in mm
Han-Eco® Reduction sealing insert			
Size of cable gland M32	19 41 000 5132		
Size of cable gland M40	19 41 000 5142		
	09 99 000 0331		

Series	Han® 100 A Axial module	Han® 100 A Crimp module	Han® 70 A Axial module	Han® 40 A Axial module
Number of contacts	2	2	2	2
Modules	Axial screw terminal 	Crimp terminal 	Axial screw terminal 	Axial screw terminal 
Rated current	100 A	100 A	70 A	40 A
Rated voltage	1000 V	1000 V	1000 V	1000 V
Wire gauge	10 ... 38 mm ²	10 ... 35 mm ²	6 ... 22 mm ²	2.5 ... 10 mm ²
Series	Han® 40 A Crimp module	Han® C Axial module	Han® C module	Han® CC Protected module
Number of contacts	2	3	3	4
Modules	Crimp terminal 	Axial screw terminal 	Crimp terminal 	Crimp terminal 
Rated current	40 A	40 A	40 A	40 A
Rated voltage	1000 V	690 V	400 / 690 V	830 V
Wire gauge	1.5 ... 10 mm ²	2.5 ... 10 mm ²	1.5 ... 10 mm ²	1.5 ... 6 mm ²
Series	Han® CD module	Han E® module	Han® EE module	Han® EE Quick Lock module
Number of contacts	3	6	8	8
Modules	Crimp terminal 	Crimp terminal 	Crimp terminal 	Quick Lock termination 
Rated current	40 A	16 A	16 A	16 A
Rated voltage	830 V	500 V	400 V	400 V
Wire gauge	1.5 ... 6 mm ²	0.14 ... 4 mm ²	0.14 ... 4 mm ²	0.5 ... 2.5 mm ²
Series	Han E® Protected module	Han® EEE module	Han® ES module	Han® HV module
Number of contacts	6	20	5	2
Modules	Crimp terminal 	Crimp terminal 	Cage-clamp terminal 	Crimp terminal 
Rated current	16 A	16 A	16 A	16 A
Rated voltage	830 V	500 V	400 V	2900 / 5000 V
Wire gauge	0.14 ... 4 mm ²	0.14 ... 4 mm ²	0.14 ... 2.5 mm ²	0.5 ... 4 mm ²

Series	Han® HV module	Han DD® module	Han DD® Quick Lock module	Han® DDD module
Number of contacts	2	12	12	17
Modules	Crimp terminal 	Crimp terminal 	Quick Lock termination 	Crimp terminal 
Rated current	40 A	10 A	10 A	10 A
Rated voltage	2900 / 5000 V	250 V	250 V	160 V
Wire gauge	1.5 ... 10 mm ²	0.14 ... 2.5 mm ²	0.25 ... 1.5 mm ²	0.14 ... 2.5 mm ²
Series	Han® High Density module	Han® D-Sub module		
Number of contacts	25	9		
Modules	Crimp terminal 	Crimp terminal 		
Rated current	4 A	5 A		
Rated voltage	50 V	50 V		
Wire gauge	0.08 ... 0.52 mm ²	0.08 ... 0.52 mm ²		
Series	Han® USB module	Han® FireWire module	Han® RJ45 module	Han® GigaBit module
Number of contacts	4	6	8	8
Modules	USB 2.0 	IEEE 1394 	Ethernet Cat. 5e 	Ethernet Cat. 6 
Series	Han-Quintax® module			
Number of contacts	2			
Modules				
Contacts	Han-Quintax® contact 4 + shielding 	High Density Quintax contact 8 + shielding 	Han D® Coax contact 75 Ω 1 + shielding  75 Ω	Han E® Coax contact 50 Ω 1 + shielding  50 Ω

Series	Han® SC module	Han-Elisa®	Han® Dummy module		
Number of contacts	4				
Modules					
Contacts	<p>SC contact for GI 50; 62.5 / 125 µm</p> 	<p>Temperature I/O modules ID module</p>			

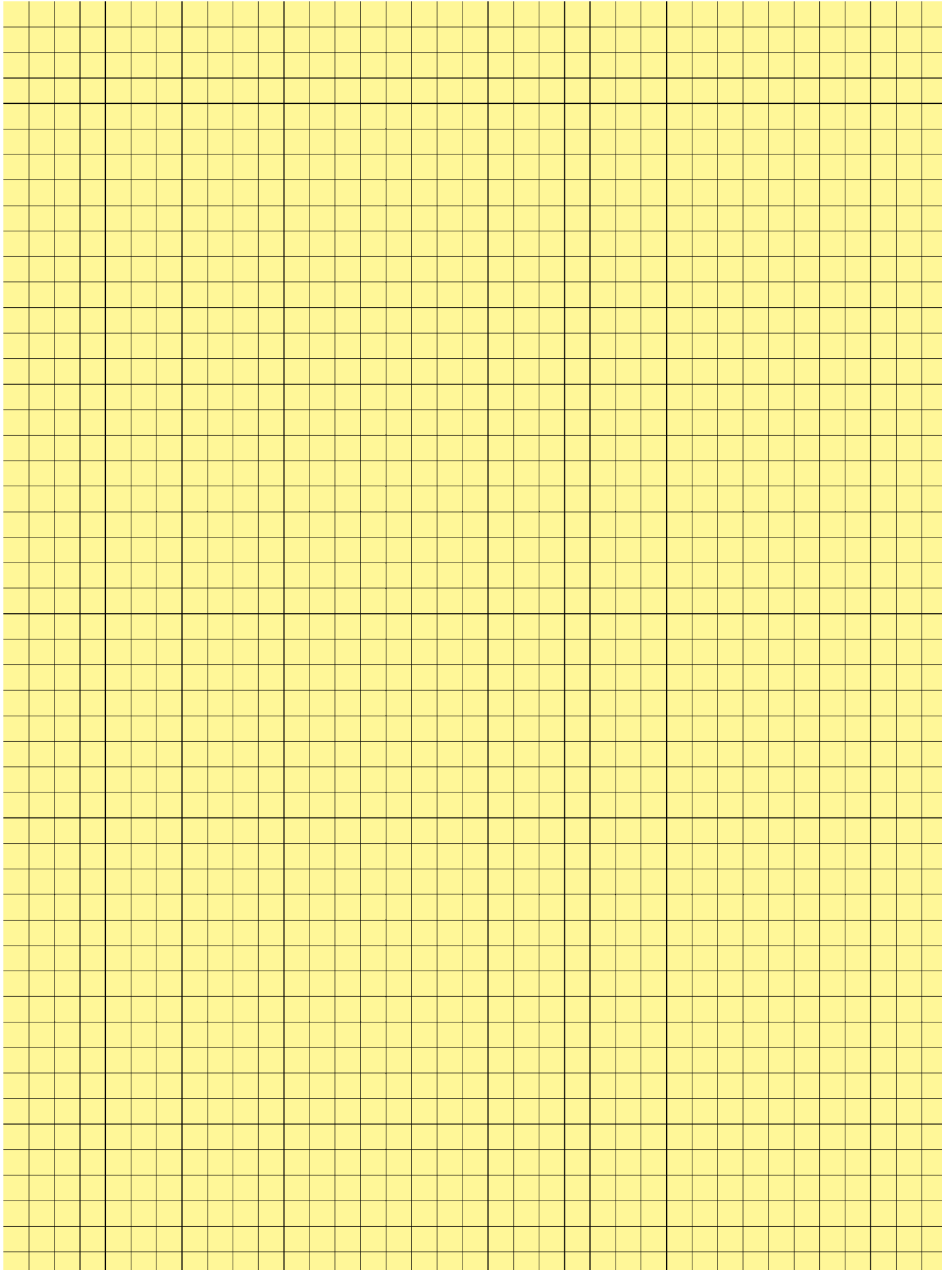

HARKIS® is the abbreviation for **HARTING-Katalog-Informationen-System** (HARTING catalogue information system).

HARKIS® is an electronic catalogue with part configuration and 3D components library. Here you can choose a connector according to your demands. Afterwards you are able to send your inquiry created with the listed parts. The drawings to every single part are available in PDF-format. The parts are downloadable in 2D-format (DXF) and 3D-format (IGES, STEP). The 3D-models can be viewed with a VRML-viewer.

You can find **HARKIS®** at www.HARKIS.HARTING.com. It is also available on CD-ROM and DVD.

Product samples:
Fast-track delivery to your desk, free of charge

With immediate effect, the new express sample dispatching service in the HARTING catalogue information system (**HARKIS®**) allows customers to order samples immediately, easily and free of charge on express delivery. A broad selection from the device connectivity product portfolio is now available. In the case of unavailable items the system offers alternative products with similar features that can be requested at a mouse click.

The samples are shipped within 48 hours after your order, free of charge. This service enables tremendous flexibility, especially in the design phase of projects.



HARKIS®

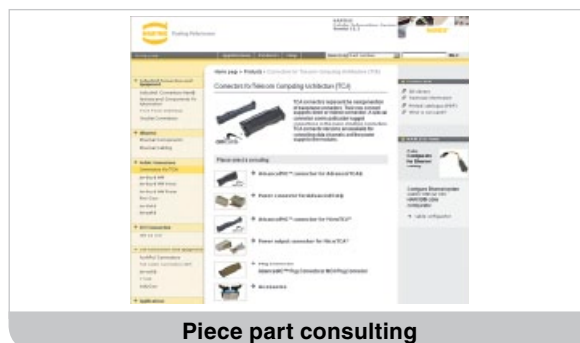

Piece part consulting

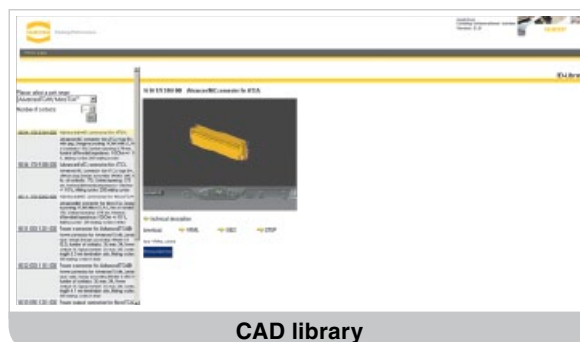

CAD library

Identification	Part number	
<p>HARKIS® CD-ROM Basic product catalogue</p>	<p>98 40 000 0405</p>	
<p>HARKIS® DVD Basic product catalogue 2D and 3D CAD files inclusive</p>		

General information

It is the customer's responsibility to check whether the components illustrated in this catalogue comply with different regulations from those stated in special fields of application which we are unable to foresee.

We reserve the right to modify designs in order to improve quality, keep pace with technological advancement or meet particular requirements in production.

No part of this catalogue may be reproduced in any form (print, photocopy, microfilm or any other process) or processed, duplicated or distributed by means of electronic systems without the written permission of HARTING Electric GmbH & Co. KG, Espelkamp. We are bound by the English version only.

Please send me further information:

DVD HARKIS®



Interface Connectors



Device Connectivity



Industrial Connectors Han®

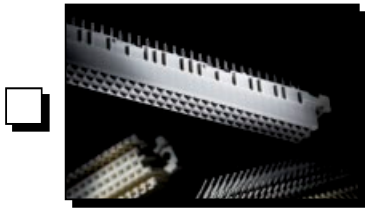

Connectors
DIN 41612

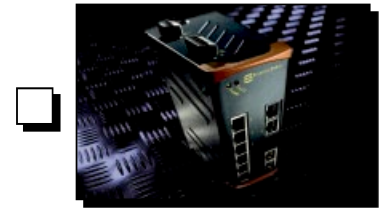

Ethernet
Network Solutions



Coaxial and Metric
Connectors



Application
brochure



TCA Connectors

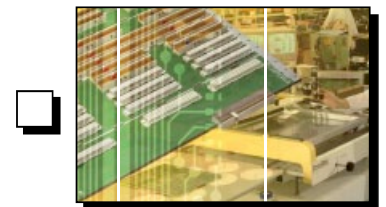

Backplanes and
Integrated Systems

Sender:

Company: _____

Street: _____

Department: _____

Postcode/Town: _____

Name: _____

Country: _____

Prenome: _____

Phone: _____

Function: _____

Fax: _____

E-Mail: _____

Please send it by post or fax to your local HARTING representatives (see page addresses) or visit us under www.HARTING.com.

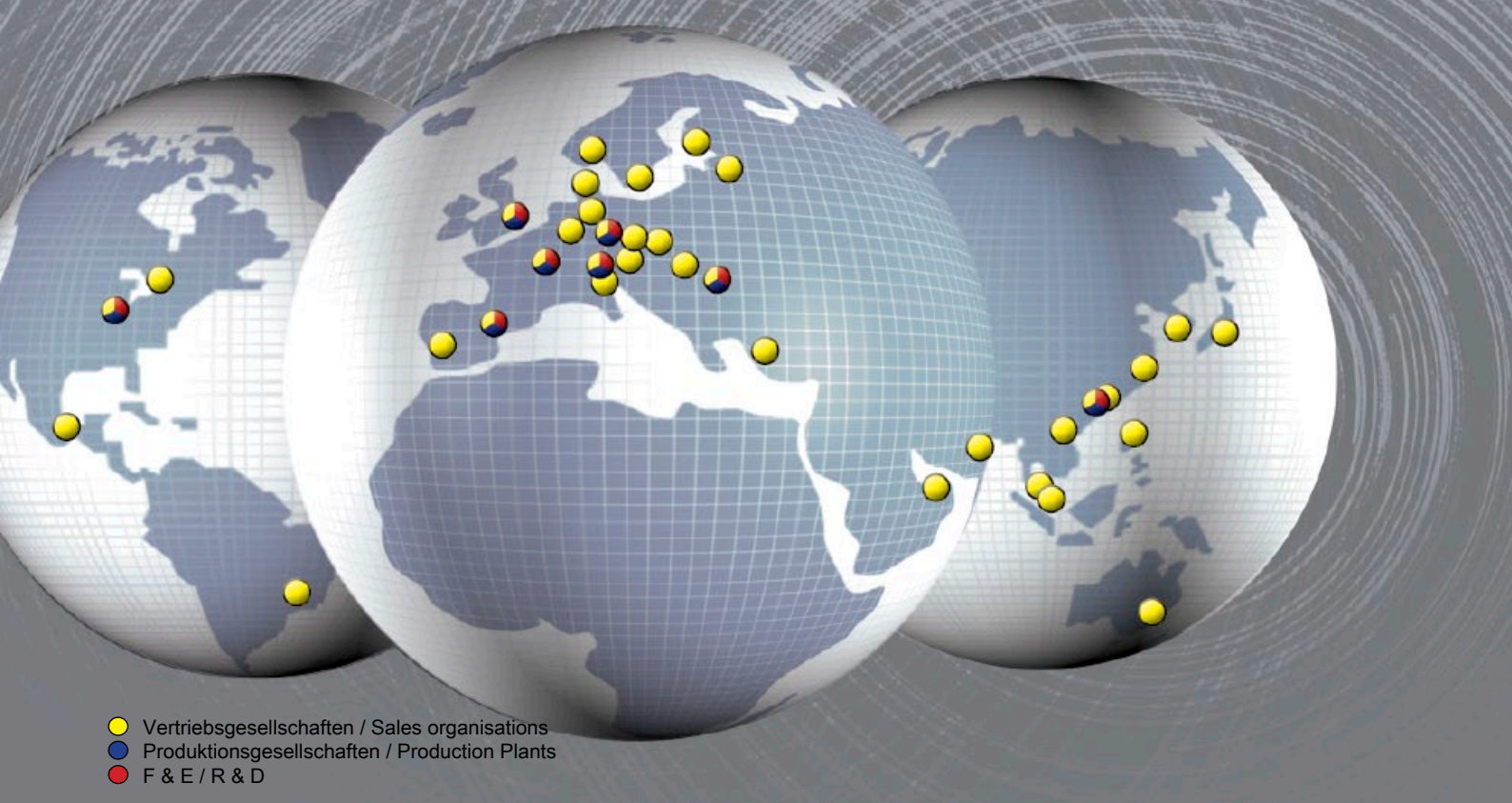

- Vertriebsgesellschaften / Sales organisations
- Produktionsgesellschaften / Production Plants
- F & E / R & D

Sales Network – worldwide



Albania

see Eastern Europe

Argentina

see Brazil

Armenia

see Eastern Europe

Australia

HARTING Pty Ltd
Suite 11 / 2 Enterprise Drive
Bundoora 3083, AUS-Victoria
Phone +61 3 9466 7088
Fax +61 3 9466 7099
au@HARTING.com
www.HARTING.com.au

Austria

HARTING Ges.m.b.H.
Deutschstraße 19, A-1230 Wien
Phone +431 6162121
Fax +431 6162121-21
at@HARTING.com
www.HARTING.at

Azerbaijan

see Eastern Europe

Bahrain

see United Arab Emirates

Belarus

see Eastern Europe

Belgium

HARTING N.V./S.A.
Z.3 Doornveld 23, B-1731 Zellik
Phone +32 2 466 0190
Fax +32 2 466 7855
be@HARTING.com
www.HARTING.be

Bosnia and Herzegovina

see Eastern Europe

Brazil

HARTING Ltda.
Av. Dr. Lino de Moraes
Pq. Jabaquara, 255
CEP 04360-001 – São Paulo –
SP – Brazil
Phone +55 11 5035 0073
Fax +55 11 5034 4743
br@HARTING.com
www.HARTING.com.br

Brunei

see Singapore

Bulgaria

see Eastern Europe

Canada

see USA

China

Zhuhai HARTING Limited
Shanghai branch
Room 5403, HK New World Tower
300 Huai Hai Road (M.), Luwan District
Shanghai 200021, China
Phone +86 21 6386 2200
Fax +86 21 6386 8636
cn@HARTING.com
www.HARTING.com.cn

Croatia

see Eastern Europe

Czech Republic

HARTING s.r.o.
Mlýnská 2, CZ-160 00 Praha 6
Phone +420 220 380 460
Fax +420 220 380 461
cz@HARTING.com
www.HARTING.cz

Denmark

HARTING ApS
Hjulmagervej 4a, DK - 7100 Vejle
Phone +45 70 25 00 32
Fax +45 75 80 64 99
dk@HARTING.com
www.HARTING.com

Eastern Europe

HARTING Eastern Europe GmbH
Bamberger Straße 7, D-01187 Dresden
Phone +49 351 4361 760
Fax +49 351 436 1770
Eastern.Europe@HARTING.com
www.HARTING.com

Estonia

see Eastern Europe

Finland

HARTING Oy
Teknobulevardi 3-5
FI-01530 Vantaa
Phone +358 207 291 510
Fax +358 207 291 511
fi@HARTING.com
www.HARTING.fi

France

HARTING France
181 avenue des Nations, Paris Nord 2
BP 66058 Tremblay en France
F-95972 Roissy Charles de Gaulle
Cédex
Phone +33 1 4938 3400
Fax +33 1 4863 2306
fr@HARTING.com
www.HARTING.fr

Germany

HARTING Deutschland GmbH & Co. KG
P.O. Box 2451, D-32381 Minden
Simeons carré 1, D-32427 Minden
Phone +49 571 8896 0
Fax +49 571 8896 282
de@HARTING.com
www.HARTING-Deutschland.de

Germany (Office)

HARTING Deutschland GmbH & Co. KG
Blankenauer Straße 99
D-09113 Chemnitz
Phone +49 0371 429211
Fax +49 0371 429222
de@HARTING.com
www.HARTING-Deutschland.de

Georgia

see Eastern Europe

Great Britain

HARTING Ltd., Caswell Road
Brackmills Industrial Estate
GB-Northampton, NN4 7PW
Phone +44 1604 827 500
Fax +44 1604 706 777
gb@HARTING.com
www.HARTING.co.uk

Hong Kong

HARTING (HK) Limited
Regional Office Asia Pacific
3512 Metroplaza Tower 1
223 Hing Fong Road
Kwai Fong, N. T., Hong Kong
Phone +852 2423 7338
Fax +852 2480 4378
ap@HARTING.com
www.HARTING.com.hk

Hungary

HARTING Magyarország Kft.
Fehérvári út 89-95, H-1119 Budapest
Phone +36 1 205 34 64
Fax +36 1 205 34 65
hu@HARTING.com
www.HARTING.hu

Iceland

Smith & Norland, Nóatún 4
IS – 105 Reykjavik
Phone +354 520 3000
Fax +354 520 3011
olaf@sminor.is, www.sminor.is

India

HARTING India Private Limited
No. D, 4th Floor, 'Doshi Towers'
No. 156 Poonamallee High Road
Kilpauk, Chennai 600 010
Tamil Nadu, India
Phone +91 44 435604 15 / 416
Fax +91 44 435604 17
in@HARTING.com
www.HARTING.in

Indonesia

see Malaysia

Israel

COMTEL
Israel Electronic Solutions Ltd.
Bet Hapamon, 20 Hataas st.
P.O.Box 66
Kefar-Saba 44425
Phone +972-9-7677240
Fax +972-9-7677243
sales@comtel.co.il
www.comtel.co.il

Italy

HARTING SpA
Via Dell' Industria 7
I-20090 Vimodrone (Milano)
Phone +39 02 250801
Fax +39 02 2650 597
it@HARTING.com
www.HARTING.it

Japan

HARTING K. K.
Yusen Shin-Yokohama 1 Chome Bldg.,
2F
1-7-9, Shin-Yokohama, Kohoku
Yokohama 222-0033 Japan
Phone +81 45 476 3456
Fax +81 45 476 3466
jp@HARTING.com
www.HARTING.co.jp

Jordan

see United Arab Emirates

Kazakhstan

see Eastern Europe

Kirghizia

see Eastern Europe

Korea (South)

HARTING Korea Limited
#308 Yatap Leaders Building,
342-1 Yatap-dong, Bundang-gu
Sungnam-City, Kyunggi-do
463-828, Republic of Korea
Phone +82 31 781 4615
Fax +82 31 781 4616
kr@HARTING.com
www.HARTING.com.cn/kr

Kosovo

see Eastern Europe

Kuwait

see United Arab Emirates

Latvia

see Eastern Europe

Lithuania

see Eastern Europe

Macedonia

see Eastern Europe

Malaysia (Office)

HARTING Singapore Pte Ltd
Malaysia Branch
11-02 Menara Amcorp
Jln. Persiaran Barat
46200 PJ, Sel. D. E., Malaysia
Phone +60 3 / 7955 6173
Fax +60 3 / 7955 5126
sg@HARTING.com

Montenegro

see Eastern Europe

Netherlands

HARTING B.V.
Larenweg 44
NL-5234 KA ,s-Hertogenbosch
Postbus 3526
NL-5203 DM ,s-Hertogenbosch
Phone +31 736 410 404
Fax +31 736 440 699
nl@HARTING.com
www.HARTINGbv.nl

New Zealand

see Australia

Norway

HARTING A/S
Østensjøveien 36, N-0667 Oslo
Phone +47 22 700 555
Fax +47 22 700 570
no@HARTING.com
www.HARTING.no

Pakistan

see United Arab Emirates

Philippines

see Malaysia

Poland

HARTING Polska Sp. z o. o.
ul. Kamieńskiego 201-219
PL-51-126 Wrocław
Phone +48 71 352 81 71
Fax +48 71 320 74 44
pl@HARTING.com
www.HARTING.pl

Portugal

HARTING Iberia, S. A.
Avda. Josep Tarradellas 20-30 4º 6a
E-08029 Barcelona
Phone +351 219 673 177
Fax +351 219 678 457
es@HARTING.com
www.HARTING.es/pt

Qatar

see United Arab Emirates

Republic of Moldova

see Eastern Europe

Romania

HARTING Romania SCS
Europa Unita str. 21
550018-Sibiu, Romania
Phone +40 369-102 671
Fax +40 369-102 622
ro@HARTING.com
www.HARTING.com

Russia

HARTING ZAO
Maliy Sampsoniyevsky prospect 2A
194044 Saint Petersburg, Russia
Phone +7 812 327 6477
Fax +7 812 327 6478
ru@HARTING.com
www.HARTING.ru

Saudi Arabia

see United Arab Emirates

Serbia

see Eastern Europe

Singapore

HARTING Singapore Pte Ltd.
25 International Business Park
#02-06 German Centre
Singapore 609916
Phone +65 6225 5285
Fax +65 6225 9947
sg@HARTING.com
www.HARTING.sg

Slovakia

HARTING s.r.o.
Sales office Slovakia
Povážska 2, SK - 940 67 Nové Zámky
Phone +421 356-493 993
Fax +421 356-402 114
sk@HARTING.com
www.HARTING.sk

Slovenia

see Eastern Europe

South Africa

HellermannTyton Pty Ltd.
Private Bag X158 Rivonia 2128
34 Milky Way Avenue
Linbro Business Park 2065, Johannes-
burg
Phone +27(0)11879-6600
Fax +27(0)11879-6606
sales.jhb@hellermann.co.za

Spain

HARTING Iberia S.A.
Avda. Josep Tarradellas 20-30 4º 6a
E-08029 Barcelona
Phone +34 93 363 84 75
Fax +34 93 419 95 85
es@HARTING.com
www.HARTING.es

Sweden

HARTING AB
Gustavslundsvägen 141 B 4tr
S-167 51 Bromma
Phone +46 8 445 7171
Fax +46 8 445 7170
se@HARTING.com
www.HARTING.se

Switzerland

HARTING AG
Industriestrasse 26
CH-8604 Volketswil
Phone +41 44 908 20 60
Fax +41 44 908 20 69
ch@HARTING.com
www.HARTING.ch

Taiwan

HARTING R.O.C. Limited
Room 1, 5/F
495 GuangFu South Road
RC-110 Taipei, Taiwan
Phone +886 2 2758 6177
Fax +886 2 2758 7177
tw@HARTING.com
www.HARTING.com.tw

Tajikistan

see Eastern Europe

Thailand

see Malaysia

Turkey

HARTING TURKEI Elektronik Ltd. Şti.
Barbaros Mah. Dereboyu Cad. Fesleğen
Sok.
Uphill Towers, A-1b Kat:8 D:45
34746 Ataşehir, İstanbul
Phone +90 216 688 81 00
Fax +90 216 688 81 01
tr@HARTING.com
www.HARTING.com.tr

Turkmenistan

see Eastern Europe

United Arab Emirates

Eurotech Fzc
Office Bldg-36, Office No. G36-02
P.O. Box 49602
Hamriyah Free Zone, Sharjah
Phone +971 6 5262077
Fax +971 6 5262117
sales@eurotech.ae
www.eurotech.ae

Ukraine

see Eastern Europe

USA

HARTING Inc. of North America
1370 Bowes Road
USA-Elgin, Illinois 60123
Phone +1 (877) 741-1500 (toll free)
Fax +1 (866) 278-0307 (Inside Sales)
us@HARTING.com
www.HARTING-USA.com

Uzbekistan

see Eastern Europe

Vietnam (Office)

HARTING Singapore Pte Ltd
Hanoi Representative Office
Suite 518, 5th Floor
Press Club Building
59A Ly Thai To Street
Hoan Kiem District
Hanoi, Vietnam
Phone +84 4 / 3936 7851
Fax +84 4 / 3936 8069
sg@HARTING.com

Distributors – worldwide



Farnell:
www.farnell.com

RS Components:
www.rs-components.com

Other countries and general contact



HARTING Electric GmbH & Co. KG
P.O. Box 1473, D-32328 Espelkamp
Phone +49 5772 47-97100
Fax +49 5772 47-495
electric@HARTING.com

Pushing Performance

