



Chipsmall Limited consists of a professional team with an average of over 10 year of expertise in the distribution of electronic components. Based in Hongkong, we have already established firm and mutual-benefit business relationships with customers from,Europe,America and south Asia,supplying obsolete and hard-to-find components to meet their specific needs.

With the principle of “Quality Parts,Customers Priority,Honest Operation,and Considerate Service”,our business mainly focus on the distribution of electronic components. Line cards we deal with include Microchip,ALPS,ROHM,Xilinx,Pulse,ON,Everlight and Freescale. Main products comprise IC,Modules,Potentiometer,IC Socket,Relay,Connector.Our parts cover such applications as commercial,industrial, and automotives areas.

We are looking forward to setting up business relationship with you and hope to provide you with the best service and solution. Let us make a better world for our industry!



## Contact us

Tel: +86-755-8981 8866 Fax: +86-755-8427 6832

Email & Skype: info@chipsmall.com Web: www.chipsmall.com

Address: A1208, Overseas Decoration Building, #122 Zhenhua RD., Futian, Shenzhen, China



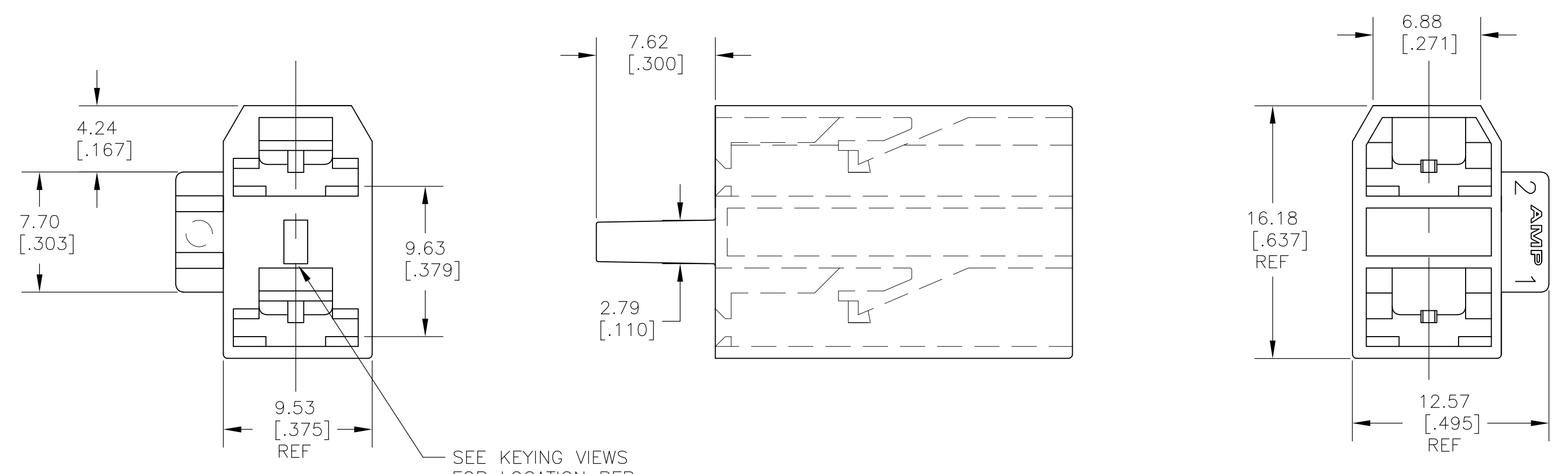

1 FITS 6.35 [.250] SERIES FASTON RECEPTACLES.  
 2 PRELIMINARY - NOT FOR PRODUCTION

SEE KEYING VIEWS FOR LOCATION PER PART NUMBERS

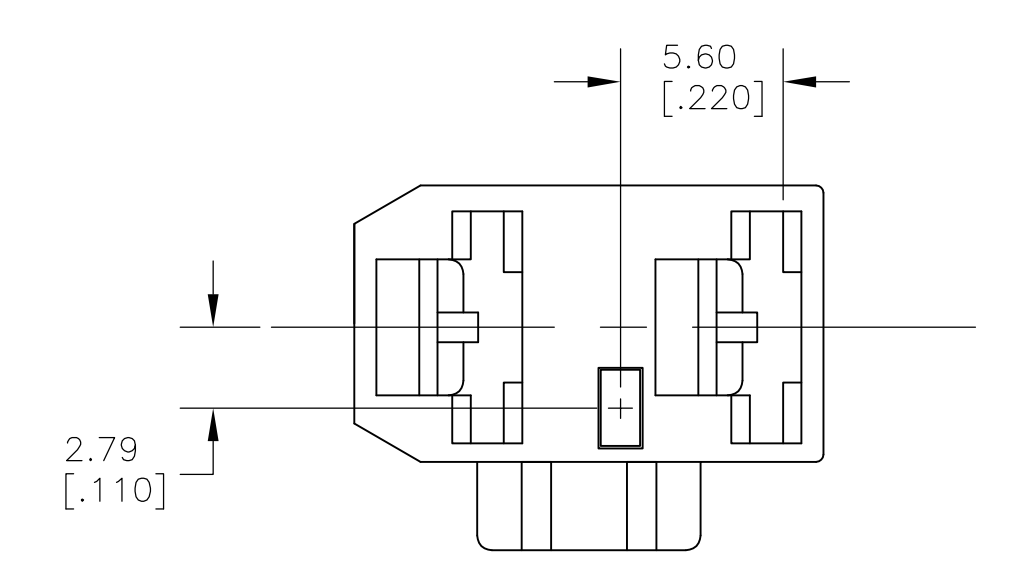
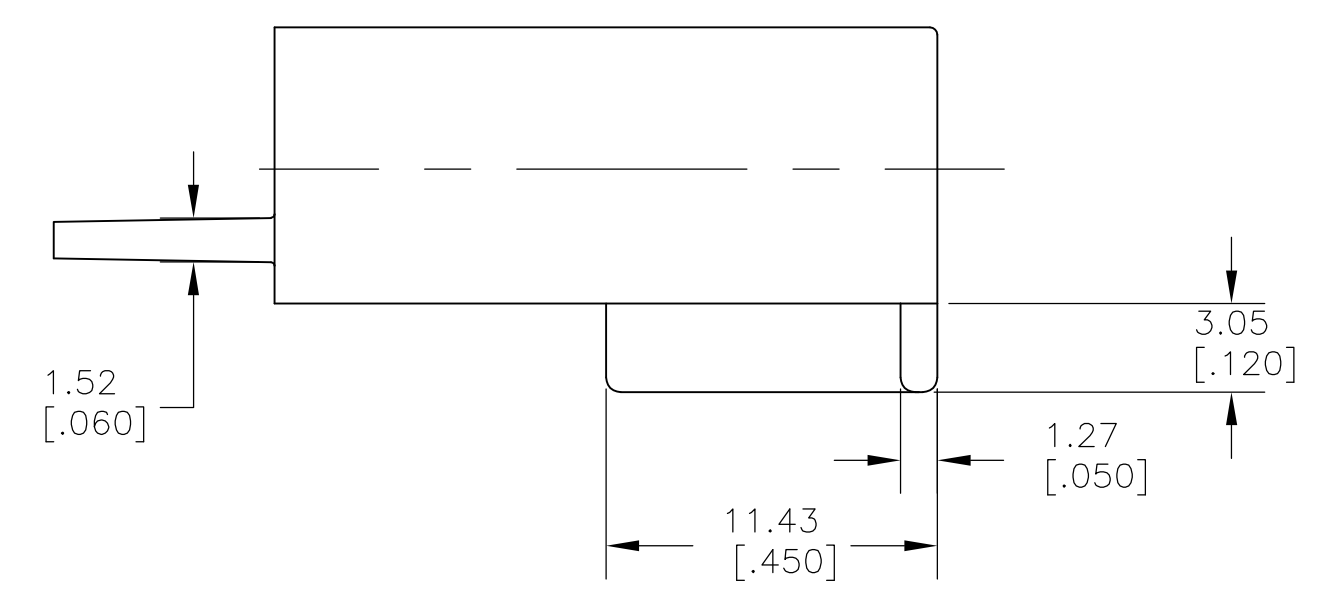

KEYING FOR -1 & -7 PART WHITE

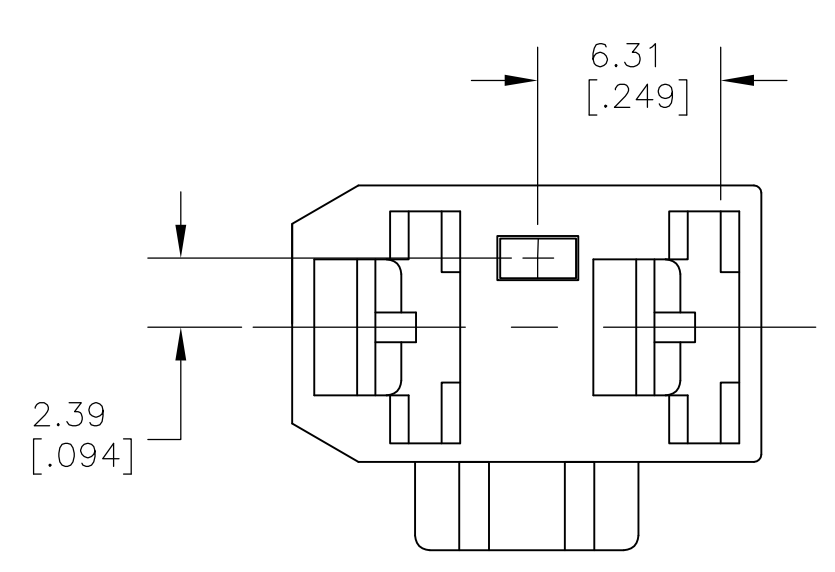

KEYING FOR -3 PART YELLOW

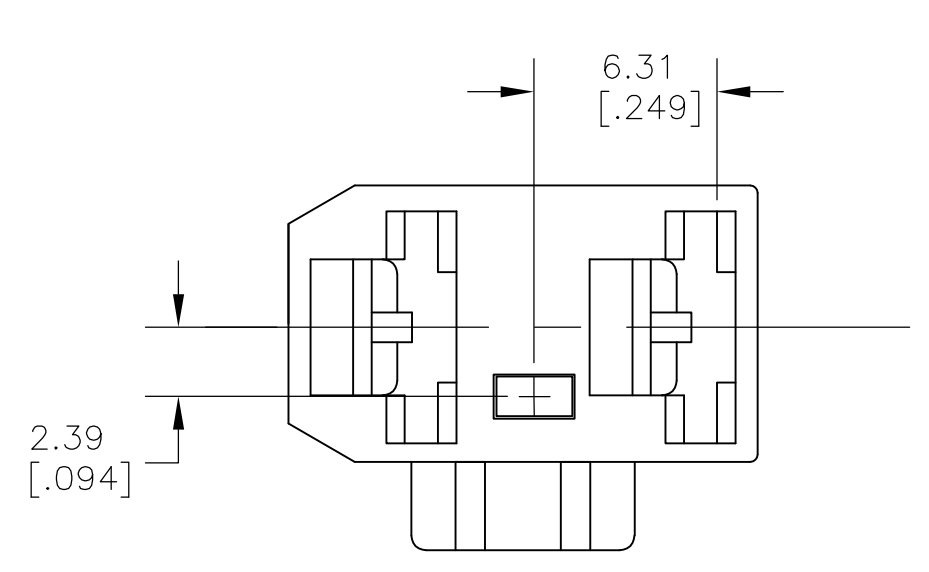

KEYING FOR -5 PART BLUE

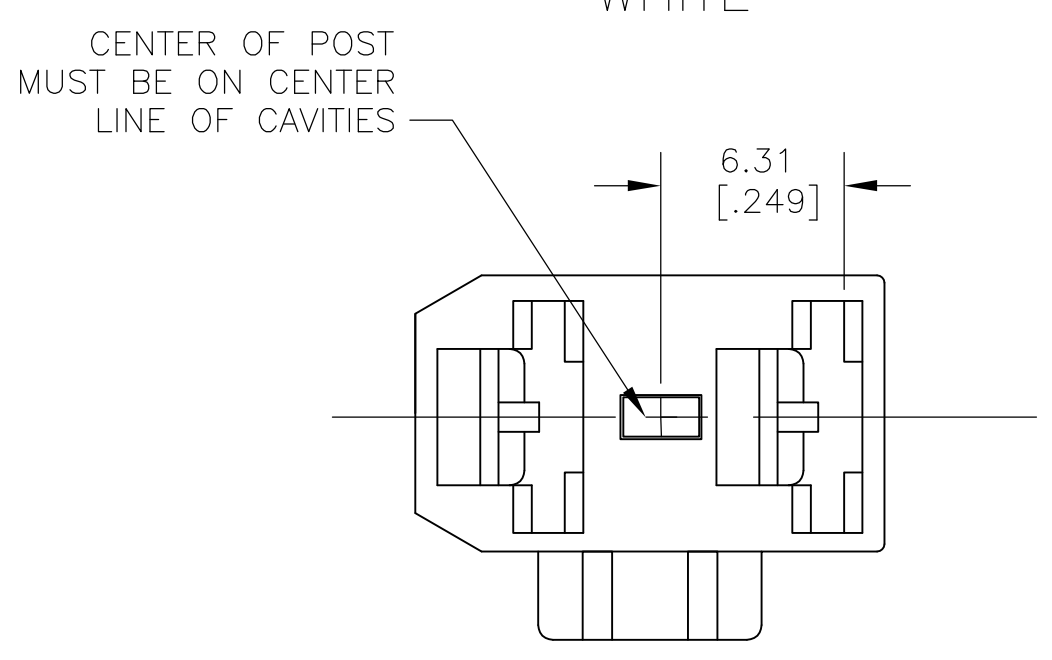

KEYING FOR -2 & -8 PART GREEN

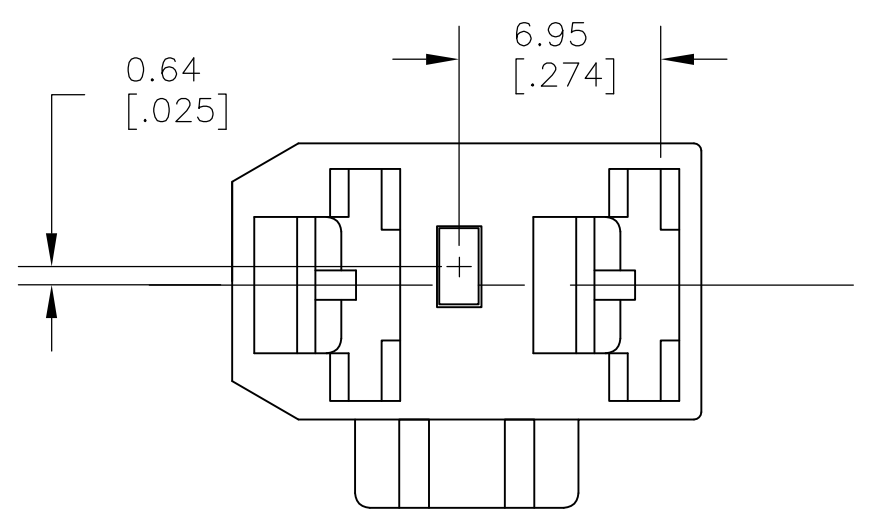

KEYING FOR -4 & 1-0 PART BLACK

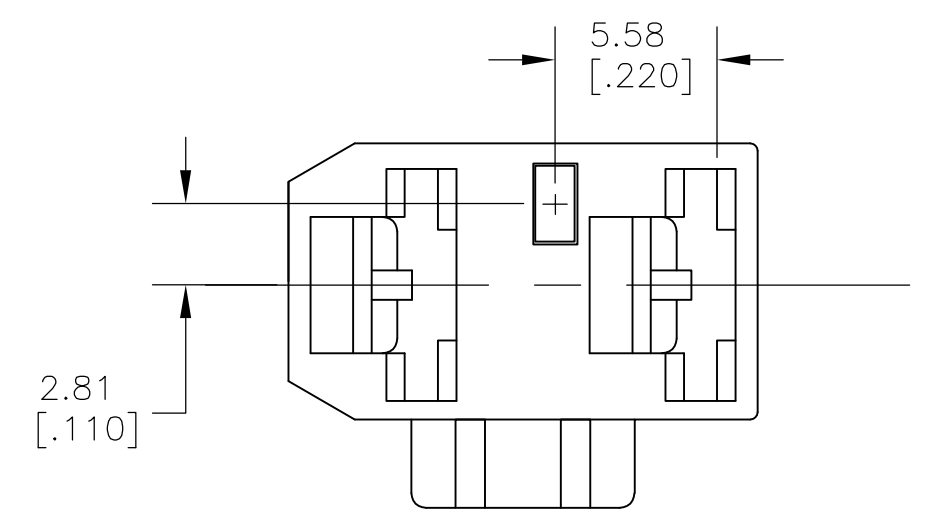

KEYING FOR -6 PART RED

BLACK	6/6 NYLON, V2	2	1-1969141-0
GREEN	6/6 NYLON, V2	2	1969141-8
WHITE	6/6 NYLON, V2	2	1969141-7
RED	66, NYLON, V0	2	1969141-6
BLUE	66, NYLON, V0	2	1969141-5
BLACK	66, NYLON, V0	2	1969141-4
YELLOW	66, NYLON, V0	2	1969141-3
GREEN	66, NYLON, V0		1969141-2
WHITE	66, NYLON, V0		1969141-1
COLOR	MATERIAL		PART NO

THIS DRAWING IS A CONTROLLED DOCUMENT.

DIMENSIONS: mm [INCHES]	TOLERANCES UNLESS OTHERWISE SPECIFIED: 0 PLC ± - 2 PLC ± - 3 PLC ± 0.25 [010] 4 PLC ± - ANGLES ± 5°	DWN jr ruth 12JUN07 CHK P DESANTIS 12JUN07 APVD P DESANTIS 12JUN07	Tyco Electronics Corporation Harrisburg, PA 17105-3608
MATERIAL SEE TABLE	FINISH COLOR - SEE TABLE	NAME HOUSING, RECEPTACLE, FASTON, 6.35 [.250] SERIES, 2 CIRCUIT	RESTRICTED TO
CUSTOMER DRAWING		SIZE A1 CAGE CODE 00779 DRAWING NO 1969141	SCALE 4:1 SHEET 1 OF 1 REV A5