



Chipsmall Limited consists of a professional team with an average of over 10 year of expertise in the distribution of electronic components. Based in Hongkong, we have already established firm and mutual-benefit business relationships with customers from,Europe,America and south Asia,supplying obsolete and hard-to-find components to meet their specific needs.

With the principle of "Quality Parts,Customers Priority,Honest Operation,and Considerate Service",our business mainly focus on the distribution of electronic components. Line cards we deal with include Microchip,ALPS,ROHM,Xilinx,Pulse,ON,Everlight and Freescale. Main products comprise IC,Modules,Potentiometer,IC Socket,Relay,Connector.Our parts cover such applications as commercial,industrial, and automotives areas.

We are looking forward to setting up business relationship with you and hope to provide you with the best service and solution. Let us make a better world for our industry!



Contact us

Tel: +86-755-8981 8866 Fax: +86-755-8427 6832

Email & Skype: info@chipsmall.com Web: www.chipsmall.com

Address: A1208, Overseas Decoration Building, #122 Zhenhua RD., Futian, Shenzhen, China



THIS DRAWING IS UNPUBLISHED. RELEASED FOR PUBLICATION 2012
 © COPYRIGHT 2012 BY TE CONNECTIVITY ALL RIGHTS RESERVED.

REVISIONS						
LOC	DIST	P	LTR	DESCRIPTION	DATE	APVD
-	-	C		REVISED PER ECR-17-002628	14MAR2017	JK
		D		REVISED PER ECR-18-004971	17APR2018	MD

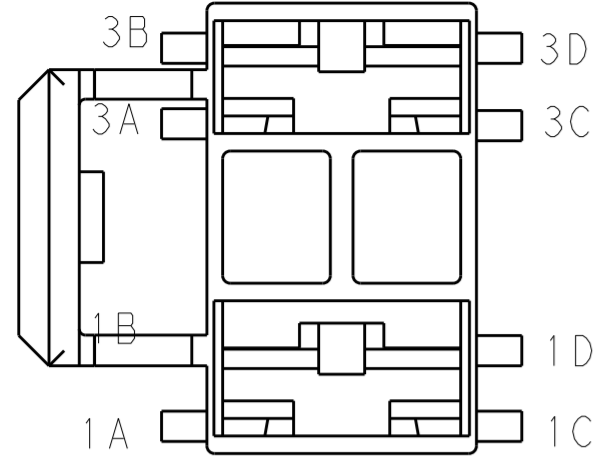

SPECIAL REAR VIEW THAT MATES WITH THE HEADER VIEWS BELOW SHOWING THE KEYING & POLARIZATION

2.79
[.110]

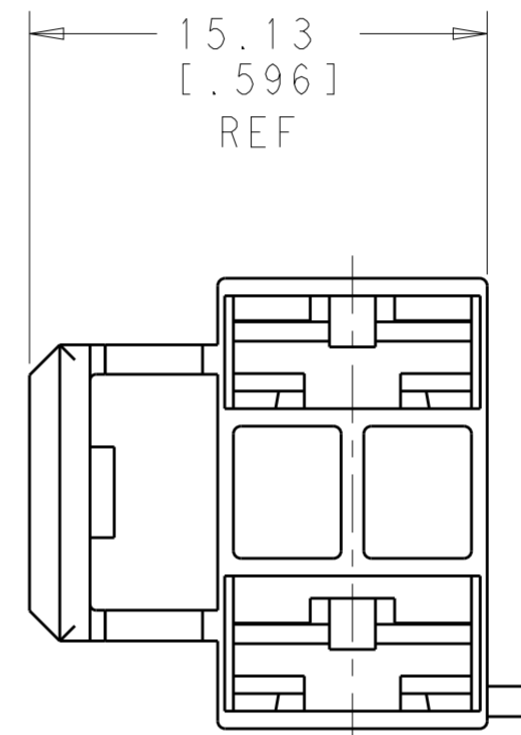
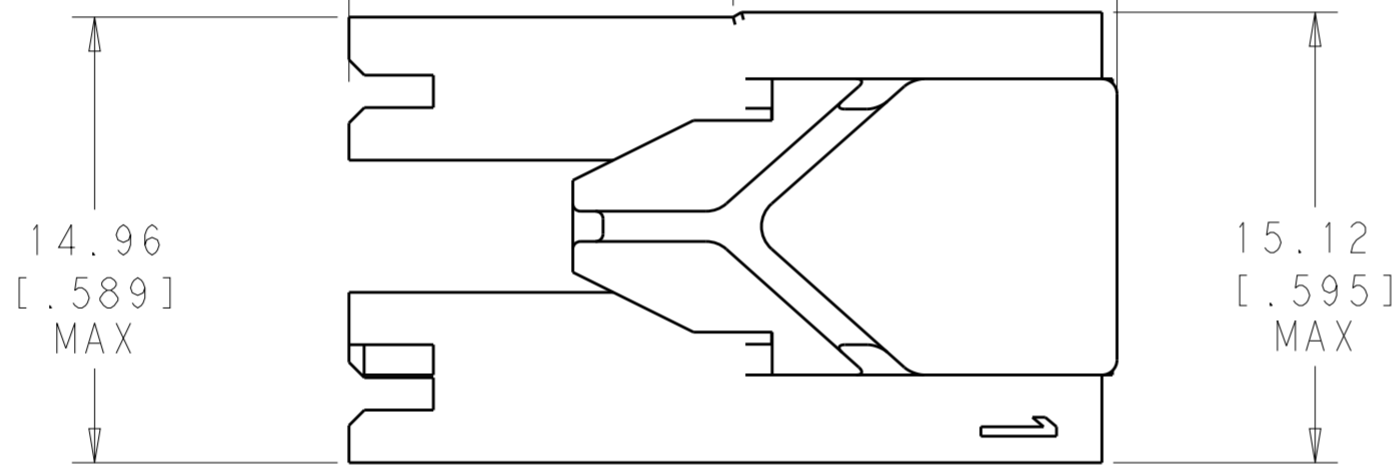
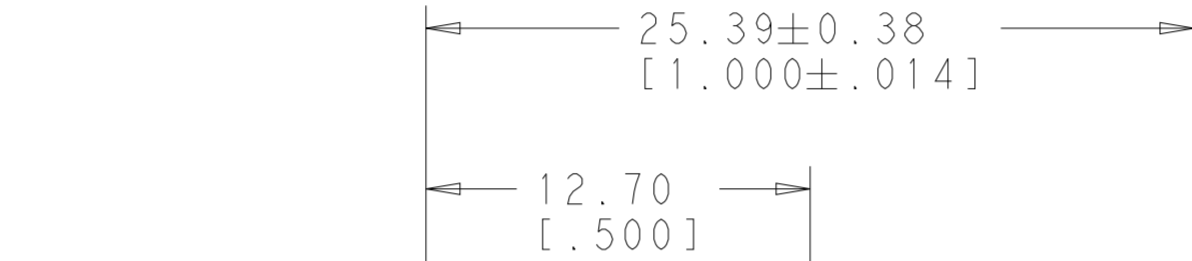
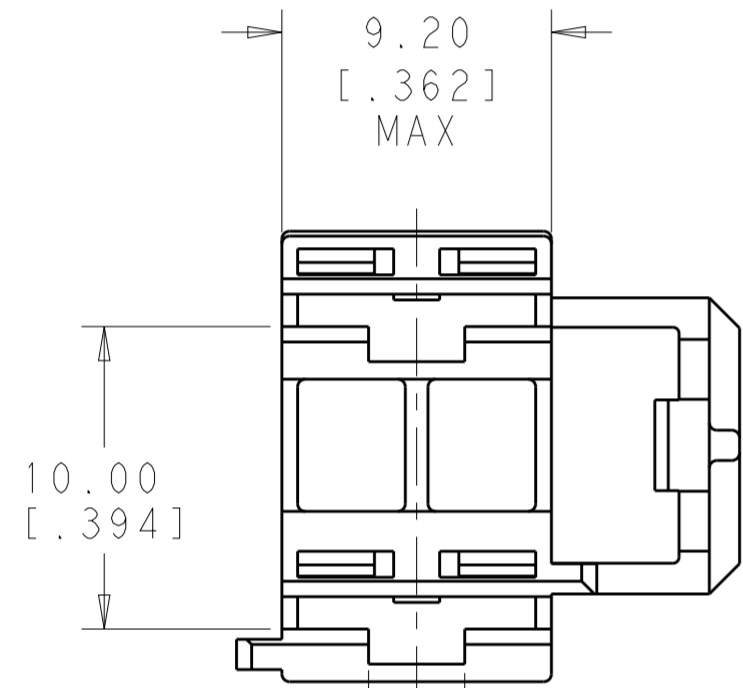
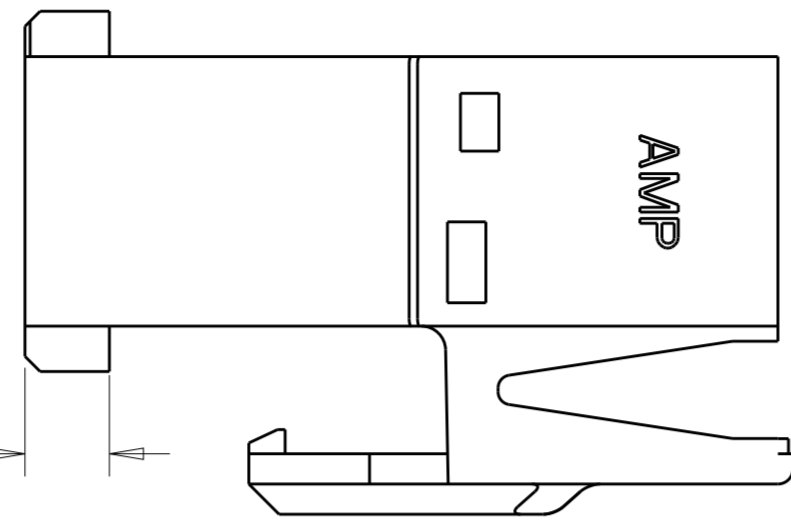

3.18 ± 0.38
[.125 ± .014]

- 1 ACCORDING TO IEC 60335-1, GWPT 750°C WITHOUT FLAME
- 2 PRELIMINARY - NOT FOR PRODUCTION
- 3 DELETED NOTE
- 4 DELETED NOTE
- 5 ACCEPTS RECEPTACLES 2238135, 2238136, 1217378, 1217094 AND 1217095

1	1C, 3C	NONE	GRAY	5-1969536-6
1	1C	1A	BLUE	5-1969536-5
1	1C	1B	BLACK	5-1969536-4
1	1D, 3D	NONE	NATURAL	5-1969536-3
1	3C	1A	YELLOW	5-1969536-2
1	1C, 3C	NONE	GREEN	5-1969536-1
	1C, 3C	NONE	GRAY	1969536-6
	1C	1A	BLUE	1969536-5
	1C	1B	BLACK	1969536-4
	1D, 3D	NONE	NATURAL	1969536-3
	3C	1A	YELLOW	1969536-2
	1C, 3C	NONE	GREEN	1969536-1
	KEYING FEATURE	POLARIZATION FEATURE	COLOR	PART NUMBER

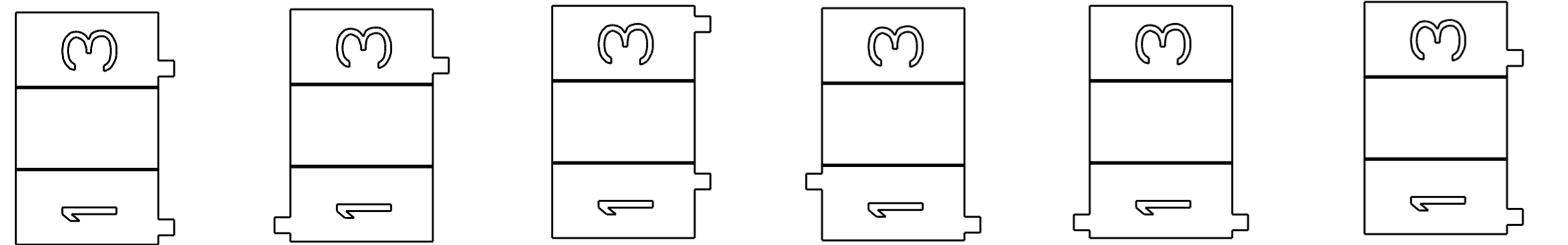

1969536-1 1969536-2 1969536-3 1969536-4 1969536-5 1969536-6
 5-1969536-1 5-1969536-2 5-1969536-3 5-1969536-4 5-1969536-5 5-1969536-6

HEADER VIEWS

THIS DRAWING IS A CONTROLLED DOCUMENT. DWN JR RUTH 19JUN2012
 CHK F LUPO 15MAR2017
 APVD R ROBONE 15MAR2017

STE TE Connectivity

NAME HOUSING, RECEPT, POSI-LOCK MK III, 6.35 [.250] SERIES, 3 POSITION, 2 CIRCUIT

SIZE A2 CAGE CODE G-1969536 DRAWING NO. RESTRICTED TO

MATERIAL NYLON TOLERANCES UNLESS OTHERWISE SPECIFIED: SEE TABLE

0 PLC ±
 1 PLC ±
 2 PLC ±0.25 [.010]
 3 PLC ±
 4 PLC ±
 ANGLES ±
 FINISH

Customer Drawing SCALE 4:1 SHEET 1 OF 1 REV D