



Chipsmall Limited consists of a professional team with an average of over 10 year of expertise in the distribution of electronic components. Based in Hongkong, we have already established firm and mutual-benefit business relationships with customers from,Europe,America and south Asia,supplying obsolete and hard-to-find components to meet their specific needs.

With the principle of “Quality Parts,Customers Priority,Honest Operation,and Considerate Service”,our business mainly focus on the distribution of electronic components. Line cards we deal with include Microchip,ALPS,ROHM,Xilinx,Pulse,ON,Everlight and Freescale. Main products comprise IC,Modules,Potentiometer,IC Socket,Relay,Connector.Our parts cover such applications as commercial,industrial, and automotives areas.

We are looking forward to setting up business relationship with you and hope to provide you with the best service and solution. Let us make a better world for our industry!



Contact us

Tel: +86-755-8981 8866 Fax: +86-755-8427 6832

Email & Skype: info@chipsmall.com Web: www.chipsmall.com

Address: A1208, Overseas Decoration Building, #122 Zhenhua RD., Futian, Shenzhen, China



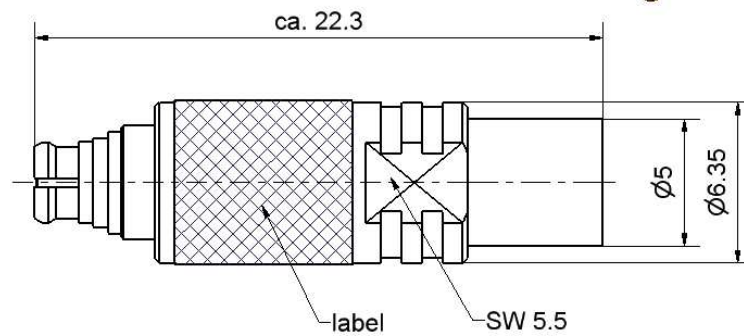

All dimensions are in mm; tolerances according to ISO 2768 m-H

Interface

According to MIL-STD-348

Documents

N/A

Material and plating

Connector parts

- Center contact
- Outer contact - plug
- Outer contact - jack
- Dielectric
- Substrate

Material

- CuBe
- Brass
- CuBe
- PTFE
- Al₂O₃

Plating

- Gold, min. 1.27 µm, over nickel
- Gold, min. 0.8 µm, over nickel
- Gold, min. 0.8 µm, over nickel

Dieses Dokument ist urheberrechtlich geschützt • This document is protected by copyright • Rosenberger Hochfrequenztechnik GmbH & Co. KG

RF_35/09;14/6.2

Electrical data

Frequency range	DC to 18 GHz
Return loss	≥ 20.8 dB, DC to 4 GHz ≥ 16.5 dB, 4 GHz to 12.4 GHz ≥ 14.0 dB, 12.4 GHz to 18 GHz
Attenuation	3 dB ± 1.0 dB, DC to 12.4 GHz 3 dB ± 1.5 dB, 12.4 GHz to 18 GHz
Power handling	≤ 0.5 W at 25°C

Mechanical data

Mating cycles	
if mating part is limited detent	≥ 500
Center contact captivation	≥ 7 N
Engagement force	
- limited detent	45 N max.
Disengagement force	
- limited detent	9 N min.

Environmental data

Temperature range	-55°C to +155°C
RoHS	compliant

Packing

Standard	1 pce in bag
Weight	3.23 g/pce

While the information has been carefully compiled to the best of our knowledge, nothing is intended as representation or warranty on our part and no statement herein shall be construed as recommendation to infringe existing patents. In the effort to improve our products, we reserve the right to make changes judged to be necessary.

Draft	Date	Approved	Date	Rev.	Engineering change number	Name	Date
Kerstin Herzog	09.05.07	Markus Müller	07.11.16	e00	15-1629	Marion Striegler	07.11.16