



Chipsmall Limited consists of a professional team with an average of over 10 year of expertise in the distribution of electronic components. Based in Hongkong, we have already established firm and mutual-benefit business relationships with customers from,Europe,America and south Asia,supplying obsolete and hard-to-find components to meet their specific needs.

With the principle of “Quality Parts,Customers Priority,Honest Operation,and Considerate Service”,our business mainly focus on the distribution of electronic components. Line cards we deal with include Microchip,ALPS,ROHM,Xilinx,Pulse,ON,Everlight and Freescale. Main products comprise IC,Modules,Potentiometer,IC Socket,Relay,Connector.Our parts cover such applications as commercial,industrial, and automotives areas.

We are looking forward to setting up business relationship with you and hope to provide you with the best service and solution. Let us make a better world for our industry!



Contact us

Tel: +86-755-8981 8866 Fax: +86-755-8427 6832

Email & Skype: info@chipsmall.com Web: www.chipsmall.com

Address: A1208, Overseas Decoration Building, #122 Zhenhua RD., Futian, Shenzhen, China





FAST RECOVERY RECTIFIERS

Qualified per MIL-PRF-19500/304*

Qualified Levels*:
JAN, JANTX, and
JANTXV

DESCRIPTION

This 1N3889 – 1N3891 and 1N3893 family of rectifier devices are suitable for applications in DC power supplies, inverters, converters, choppers and ultrasonic systems as well as other applications. It can also be used as a free-wheeling diode. They are military qualified up to a JANTXV level on select part numbers and they are available in both standard and reverse polarities. Microsemi also offers numerous other products to meet higher and lower power voltage regulation applications.

Important: For the latest information, visit our website <http://www.microsemi.com>.

FEATURES

- Very low forward voltage.
- Fast recovery time.
- Low thermal resistance.
- Both polarities available.
- JAN, JANTX, and JANTXV qualifications also available per MIL-PRF-19500/304.
*(Excludes part number 1N3889.)
- RoHS compliant devices available by adding “e3” suffix.

APPLICATIONS / BENEFITS

- Available in 12 or 20 amp current ratings.
- Short reverse recovery time.
- High surge capability.
- Hermetically sealed.

MAXIMUM RATINGS @ T_C = 25 °C unless otherwise noted

Parameters/Test Conditions	Symbol	Value	Unit
Junction and Storage Temperature	T _J & T _{STG}	-65 to +175	°C
Thermal Resistance Junction-to-Case	R _{θJC}	2.0	°C/W
non “A” “A”		1.5	
Reverse Voltage	V _R	100	V
1N3890 A/R/AR		200	
1N3891 A/R/AR		400	
Working Peak Reverse Voltage	V _{RWM}	50	V (pk)
1N3889 A/R/AR		100	
1N3890 A/R/AR		200	
1N3891 A/R/AR		400	
Repetitive Peak Reverse Voltage	V _{RRM}	50	V
1N3889 A/R/AR		100	
1N3890 A/R/AR		200	
1N3891 A/R/AR		400	
Average Forward Current, 180 degrees conduction angle, 60 Hz, half sine wave @ T _C = 100 °C	I _O	12	A
non “A” “A”		20	
Maximum Non-Repetitive Sinusoidal Surge Current @ T _C = 100 °C (8.3 ms, half sine)	I _{FSM}	175	A (pk)
non “A” “A”		250	

NOTES: 1. Derate linearly 2 % of I_O/°C for T_C > 100 °C, see [Figure 5](#).



**DO-203AA (DO-4)
Package**

MSC – Lawrence
6 Lake Street,
Lawrence, MA 01841
Tel: 1-800-446-1158
(978) 620-2600
Fax: (978) 689-0803

MSC – Ireland
Gort Road Business Park,
Ennis, Co. Clare, Ireland
Tel: +353 (0) 65 6840044
Fax: +353 (0) 65 6822298

Website:
www.microsemi.com

MECHANICAL and PACKAGING

- CASE: Hermetically sealed metal and glass case body with 10-32 UNF3A threaded stud.
- TERMINALS: Tin-lead plated or RoHS compliant matte-tin plating on nickel. Solder dipped eyelet.
- MARKING: Manufacturer's ID, part number, date code, polarity symbol.
- WEIGHT: 5 grams (approximate).
- Maximum Stud Torque: 10-15 inch pounds.
- See [Package Dimensions](#) on last page.

PART NOMENCLATURE

Applicable to 1N3889 only:

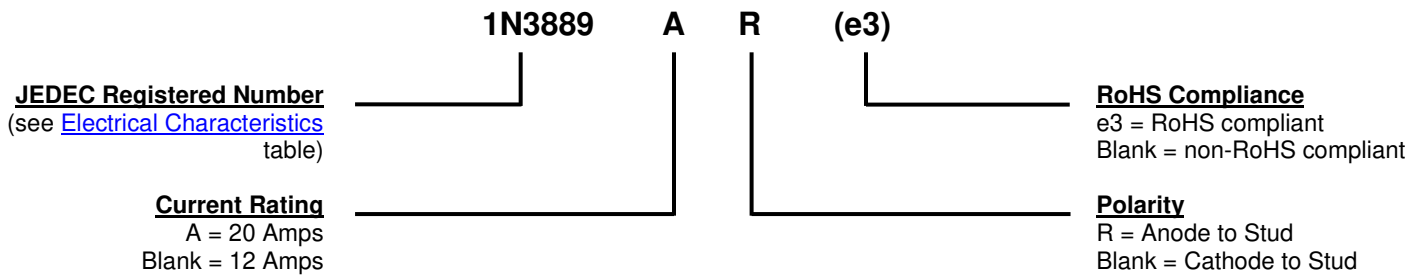

Applicable to 1N3890, 1N3891 and 1N3893 only:

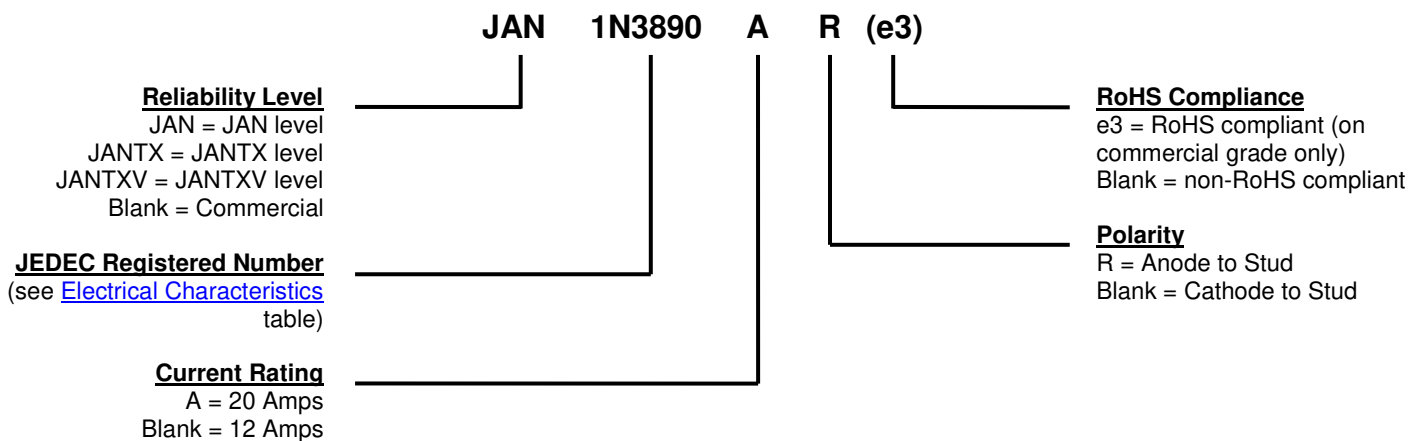

SYMBOLS & DEFINITIONS	
Symbol	Definition
C_J	Junction Capacitance: The junction capacitance in pF at a specified frequency.
$I_{F(AV)}$	Average Forward Current: The average forward current dc value, no alternating component.
I_{FSM}	Maximum Forward Surge Current: The forward current, surge peak or rated forward surge current.
I_{RM}	Maximum Reverse Current: The maximum reverse (leakage) current that will flow at the specified voltage and temperature.
t_{rr}	Reverse Recovery Time: The time interval between the instant the current passes through zero when changing from the forward direction to the reverse direction and a specified decay point after a peak reverse current occurs.
V_{FM}	Maximum Forward Voltage: The maximum forward voltage the device will exhibit at a specified current.
V_{RRM}	Repetitive Peak Reverse Voltage: The peak reverse voltage including all repetitive transient voltages but excluding all non-repetitive transient voltages.
V_{RWM}	Working Peak Reverse Voltage: The maximum peak voltage that can be applied over the operating temperature range excluding all transient voltages (ref JESD282-B). Also sometimes known as PIV.

ELECTRICAL CHARACTERISTICS @ $T_A = 25\text{ }^\circ\text{C}$ unless otherwise noted

Type	Typical Junction Capacitance C_J	Average Forward Current $I_{F(AV)}$	Maximum Forward Voltage V_{FM}	Maximum Reverse Current I_{RM}		Maximum Reverse Recovery Time t_{rr}
		$T_C = 100\text{ }^\circ\text{C}$	$T_C = 25\text{ }^\circ\text{C}$	$T_C = 25\text{ }^\circ\text{C}$	$T_C = 150\text{ }^\circ\text{C}$	
1N3889(R)	115 pF ⁽¹⁾	12 A	1.5 V @ $I_{FM} = 20\text{ A}$ ⁽²⁾	10 μA @ V_{RRM}	2 mA @ V_{RRM}	200 ns ⁽³⁾

- NOTES:**
- $V_R = 10\text{ V}$, $f = 1\text{ Mhz}$, $T_J = 25\text{ }^\circ\text{C}$.
 - $I_{FM} = 38\text{ A}$, $T_J = 25\text{ }^\circ\text{C}$. Pulse test: pulse width 300 μsec , duty cycle 2%.
 - $I_F = 1\text{ A}$, $V_R = 30\text{ A}$, $di/dt = 25\text{ A}/\mu\text{s}$, $T_C = 55\text{ }^\circ\text{C}$.

Parameters / Test Conditions	Symbol	Min.	Max.	Unit
Forward Voltage $I_{FM} = 38\text{ A}$, $T_C = 25\text{ }^\circ\text{C}$ *	V_{FM}		1.5	V
Forward Voltage $I_{FM} = 250\text{ A}$, $T_C = 150\text{ }^\circ\text{C}$ **	V_{FM}		2.75	V
Reverse Current $V_{RM} = 100\text{ V}$, $T_C = 25\text{ }^\circ\text{C}$ $V_{RM} = 200\text{ V}$, $T_C = 25\text{ }^\circ\text{C}$ $V_{RM} = 400\text{ V}$, $T_C = 25\text{ }^\circ\text{C}$	I_{RM}		10	μA
Reverse Current $V_{RM} = 100\text{ V}$, $T_C = 150\text{ }^\circ\text{C}$ $V_{RM} = 200\text{ V}$, $T_C = 150\text{ }^\circ\text{C}$ $V_{RM} = 400\text{ V}$, $T_C = 150\text{ }^\circ\text{C}$	I_{RM}		2	mA
Reverse Recovery Time $V_{RM} = 30\text{ V}$, $I_F = 1\text{ A}$, $T_C = 55\text{ }^\circ\text{C}$ *	T_{rr}		200 150	ns

* Pulse test: Pulse width 300 μsec , duty cycle 2%.

** Pulse test: Pulse width 800 μsec .

GRAPHS

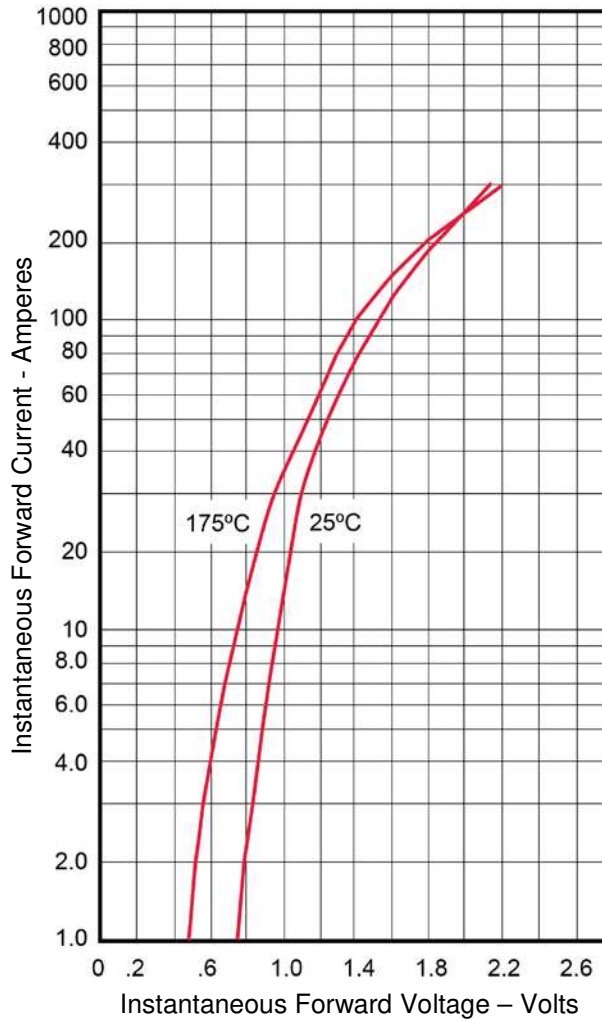

FIGURE 1 – Typical Forward Characteristics

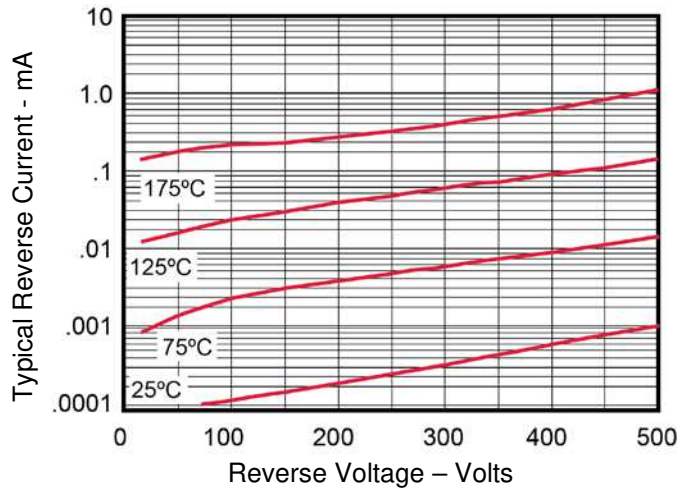

FIGURE 2 – Typical Reverse Characteristics

GRAPHS (continued)

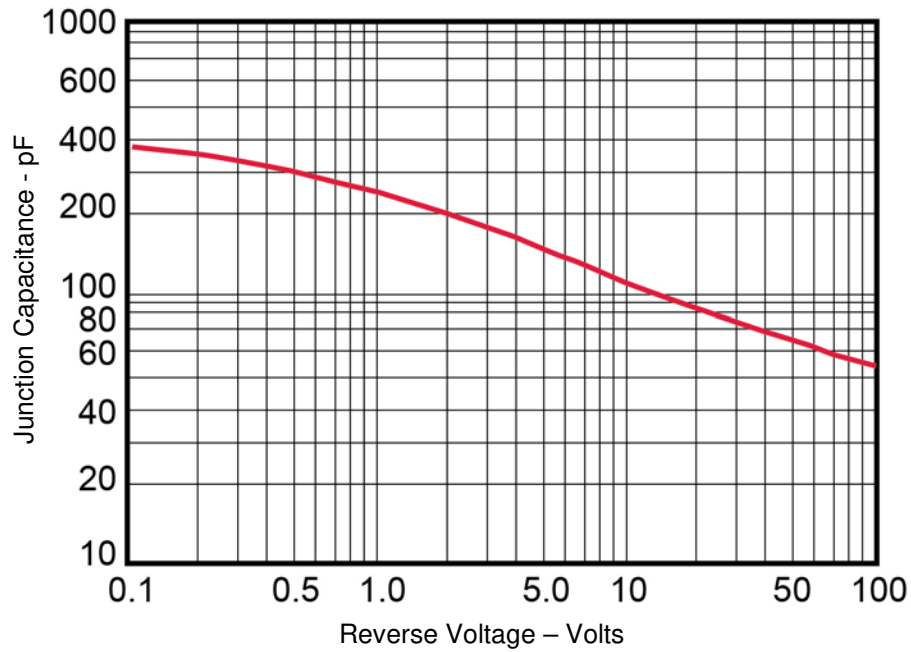

FIGURE 3 – Typical Junction Capacitance

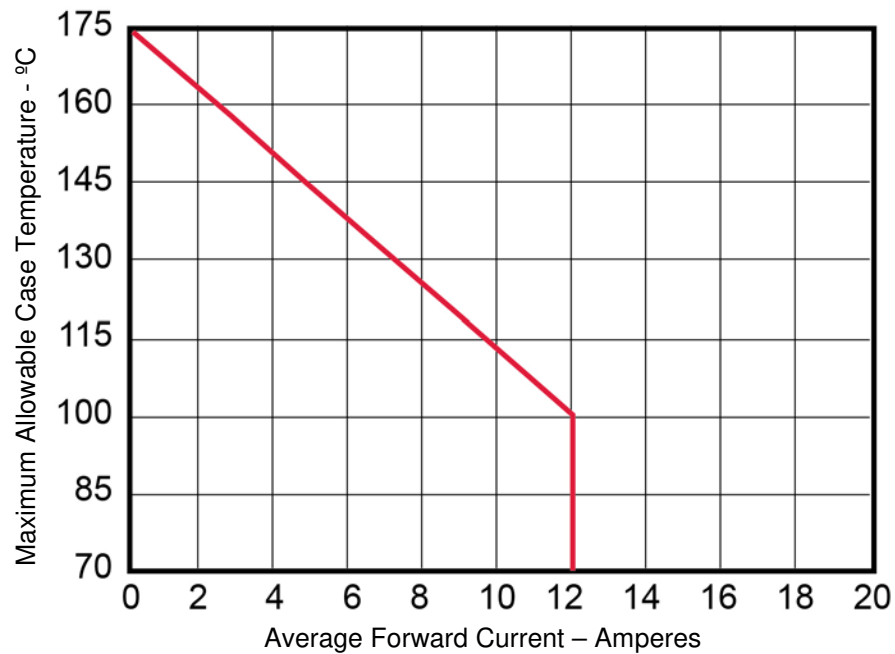

FIGURE 4 – Forward Current Derating

GRAPHS (continued)

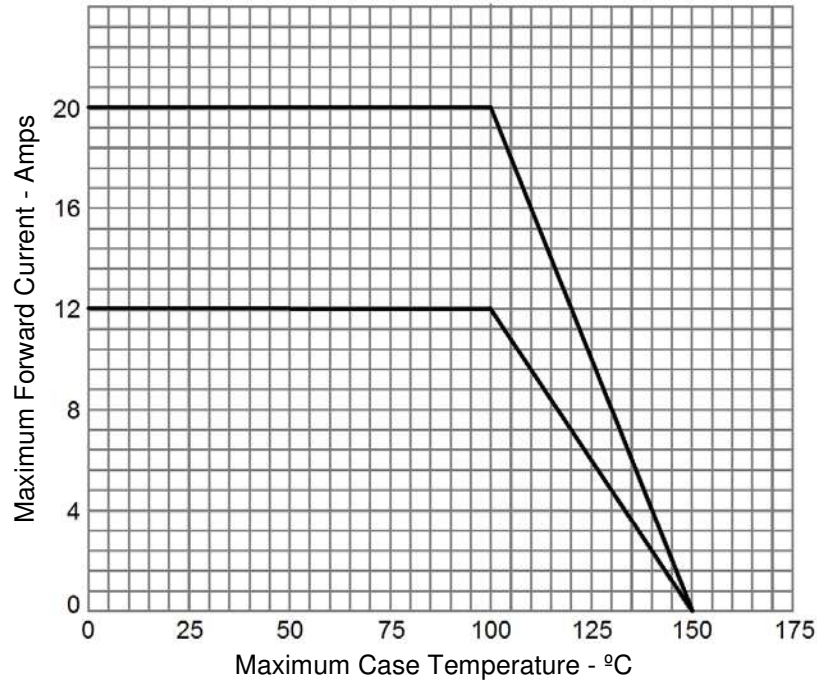

Figure 5 – Maximum Forward Current vs. Maximum Case Temperature

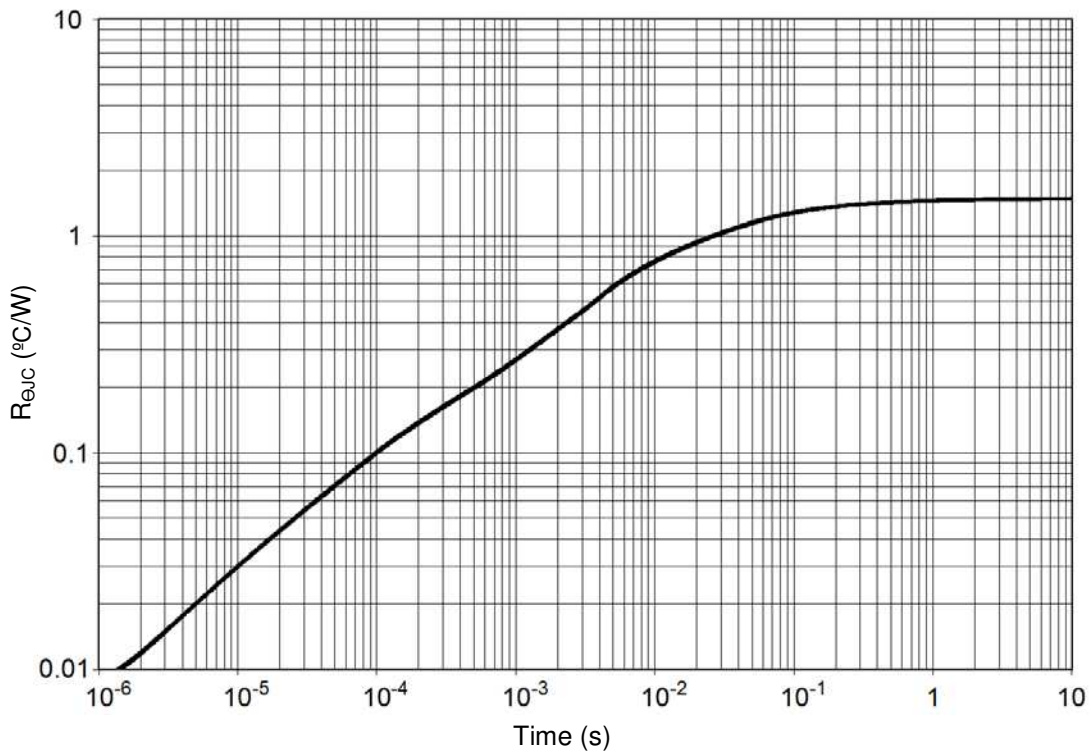
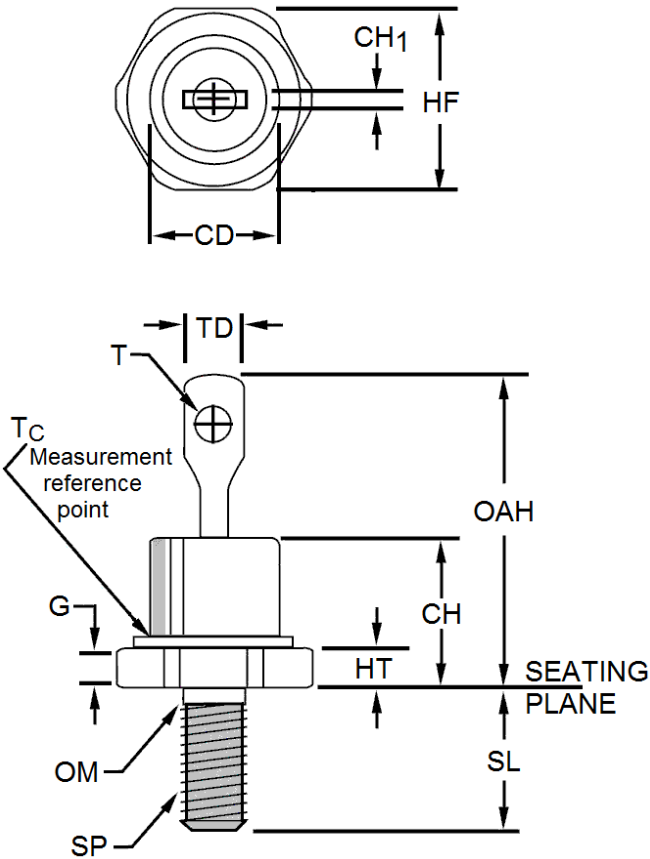

Figure 6 – Thermal Impedance for “A” type devices

PACKAGE DIMENSIONS

Ltr	Dimensions				Notes
	Inch		Millimeters		
	Min	Max	Min	Max	
CD		.424		10.77	
CH		.405		10.29	
CH ₁	.020	.065	0.51	1.65	9
G	.060		1.52		
HF	.424	.437	10.77	11.10	
HT	.075	.175	1.90	4.44	
OAH		.800		20.32	
OM	.163	.189	4.14	4.80	4
SL	.422	.453	10.72	11.50	
SP					5, 6, 7, 8
T	.060		1.52		
TD		.250		6.35	

NOTES:

- Dimensions are in inches.
- Millimeters are given for general information only.
- Angular orientation of this terminal is undefined. Square or radius on end of terminals is optional.
- Diameter variations within these limits are permitted.
- The ANSI thread reference is 0.190-32 UNF-2A.
- Max pitch diameter of plated threads shall be basic pitch diameter 0.169 inch (4.29 mm) reference FED-STD-H28 (Screw Thread Standards for Federal Services.)
- Units must not be damaged by torque of 15 inch-pounds applied to 0.190-32 UNF-2B nut assembled on thread.
- Complete threads to extend to within 0.078 inch (1.98 mm) of the seating plane.
- Terminal-end shape is unrestricted.
- Reversed (anode to stud) units shall be marked with an "R" following the last digit in the type number.
- Forward polarity (cathode to stud) marking is not shown.