



Chipsmall Limited consists of a professional team with an average of over 10 year of expertise in the distribution of electronic components. Based in Hongkong, we have already established firm and mutual-benefit business relationships with customers from,Europe,America and south Asia,supplying obsolete and hard-to-find components to meet their specific needs.

With the principle of “Quality Parts,Customers Priority,Honest Operation,and Considerate Service”,our business mainly focus on the distribution of electronic components. Line cards we deal with include Microchip,ALPS,ROHM,Xilinx,Pulse,ON,Everlight and Freescale. Main products comprise IC,Modules,Potentiometer,IC Socket,Relay,Connector.Our parts cover such applications as commercial,industrial, and automotives areas.

We are looking forward to setting up business relationship with you and hope to provide you with the best service and solution. Let us make a better world for our industry!



Contact us

Tel: +86-755-8981 8866 Fax: +86-755-8427 6832

Email & Skype: info@chipsmall.com Web: www.chipsmall.com

Address: A1208, Overseas Decoration Building, #122 Zhenhua RD., Futian, Shenzhen, China



RFHA1004

25W GaN Wide-Band Power Amplifier 700MHz to 2500MHz

The RFHA1004 is a wideband Power Amplifier designed for CW and pulsed applications such as wireless infrastructure, RADAR, military communication radios and general purpose amplification. Using an advanced high power density Gallium Nitride (GaN) semiconductor process, these high-performance amplifiers achieve high efficiency, flat gain and large instantaneous bandwidth in a single amplifier design. The RFHA1004 is an input matched GaN transistor packaged in an air cavity copper package which provides excellent thermal stability through the use of advanced heat sink and power dissipation technologies. Ease of integration is accomplished through the incorporation of optimized input matching network within the package that provides wideband gain and power performance in a single amplifier. An external output match offers the flexibility of further optimizing power and efficiency for any sub-band within the overall bandwidth.

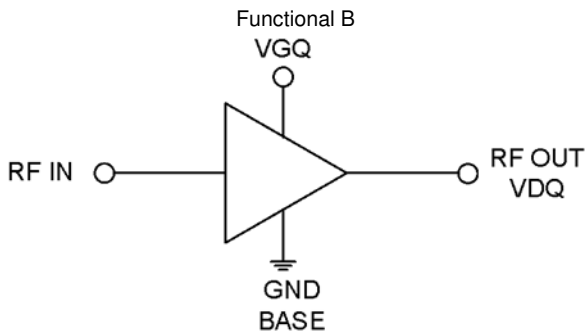

Functional Block Diagram

Ordering Information

| | |
|------------------|--|
| RFHA1004S2 | Sample bag with 2 pieces |
| RFHA1004SB | Bag with 5 pieces |
| RFHA1004SQ | Bag with 25 pieces |
| RFHA1004SR | Short Reel with 100 pieces |
| RFHA1004TR7 | 7" Reel with 750 pieces |
| RFHA1004PCBA-410 | Evaluation Board: 700MHz to 2500MHz; 52V Operation |



Package: Air-Cavity Cu

Features

- Advanced GaN HEMT Technology
- Output Power of 25W
- Advanced Heat-Sink Technology
- 700MHz to 2500MHz Instantaneous Bandwidth
- Input Internally Matched to 50Ω
- 52V Operation Typical Performance
 - P_{OUT} 43dBm
 - Gain 11dB
 - Power Added Efficiency 45% (700MHz to 2500MHz)
- -40°C to 85°C Operating Temperature
- Large Signal Models Available
- EAR99 Export Control

Applications

- Class AB Operation for Public Mobile Radio
- Power Amplifier Stage for Commercial Wireless Infrastructure
- General Purpose Tx Amplification
- Test and Instrumentation
- Civilian and Military Radar

Absolute Maximum Ratings

| Parameter | Rating | Unit |
|--|-------------|-------|
| Drain Voltage (V_D) | 150 | V |
| Gate Voltage (V_G) | -8 to +2 | V |
| Operational Voltage | 54 | V |
| RF - Input Power | 38 | dBm |
| Ruggedness (VSWR) | 10:1 | |
| Storage Temperature Range | -55 to +125 | °C |
| Operating Temperature Range (T_o) | -40 to +85 | °C |
| Operating Junction Temperature (T_J) | 200 | °C |
| Human Body Model | Class 1A | |
| MTTF ($T_J < 200$ °C, 95% Confidence Limits)* | 3E + 06 | Hours |
| Thermal Resistance, R_{TH} (junction to case) measured at $T_C = 85$ °C, DC bias only | 5.2 | °C/W |



Caution! ESD sensitive device.



RoHS (Restriction of Hazardous Substances): Compliant per EU Directive 2011/65/EU.

Exceeding any one or a combination of the Absolute Maximum Rating conditions may cause permanent damage to the device. Extended application of Absolute Maximum Rating conditions to the device may reduce device reliability. Specified typical performance or functional operation of the device under Absolute Maximum Rating conditions is not implied.

* MTTF – median time to failure for wear-out failure mode (30% I_{DSS} degradation) which is determined by the technology process reliability. Refer to product qualification report for FIT (random) failure rate.

Operation of this device beyond any one of these limits may cause permanent damage. For reliable continuous operation, the device voltage and current must not exceed the maximum operating values specified in the table on page two.

Bias Conditions should also satisfy the following expression: $P_{DISS} < (T_J - T_C) / R_{TH} J - C$ and $T_C = T_{CASE}$

Nominal Operating Parameters

| Parameter | Specification | | | Unit | Condition |
|---|---------------|-------|-------|-------|--------------------------------------|
| | Min | Typ | Max | | |
| Recommended Operating Conditions | | | | | |
| Drain Voltage (V_{DSQ}) | | 52 | | V | |
| Gate Voltage (V_{GSQ}) | -4 | -3.2 | -2.5 | V | |
| Drain Bias Current | | 88 | | mA | |
| RF Input Power (P_{IN}) | | | 35 | dBm | |
| Input Source VSWR | | | 10:1 | | |
| Maximum Gate Current (I_g) | | | 15.25 | mA | P3dB, CW |
| RF Performance Characteristics | | | | | |
| Frequency Range | 700 | | 2500 | MHz | Small signal 3dB bandwidth |
| Linear Gain | | 11.5 | | dB | $P_{IN} = 0$ dBm, 700MHz to 2500MHz |
| Power Gain | | 10 | | dB | $P_{IN} = 33$ dBm, 700MHz to 2500MHz |
| Gain Variation with Temperature | | -0.02 | | dB/°C | |
| Input Return Loss (S11) | | -10 | | dB | |
| Output Power (P3dB) | | 43 | | dBm | 700MHz to 2500MHz |
| Power Added Efficiency (PAE) | | 43 | | % | 700MHz to 2500MHz |

| Parameter | Specification | | | Unit | Condition |
|------------------------------|---------------|------|-----|------|--|
| | Min | Typ | Max | | |
| RF Functional Tests | | | | | Test Conditions: $V_{DSQ} = 52V$, $I_{DQ} = 88mA$, CW, $f = 1600MHz$, $T = 25^{\circ}C$, Performance in a standard tuned test fixture |
| V_{GSQ} | | -3.2 | | V | |
| Power Gain | | 10.5 | | dB | $P_{IN} = 33dBm$ |
| Input Return Loss | | -10 | | dB | $P_{IN} = 33dBm$ |
| Output Power | | 43.5 | | dBm | $P_{IN} = 33dBm$ |
| Power Added Efficiency (PAE) | | 40 | | % | $P_{IN} = 33dBm$ |

Typical Performance in standard fixed tuned test fixture matched for 700MHz to 2500MHz
 (T = 25°C, unless noted)

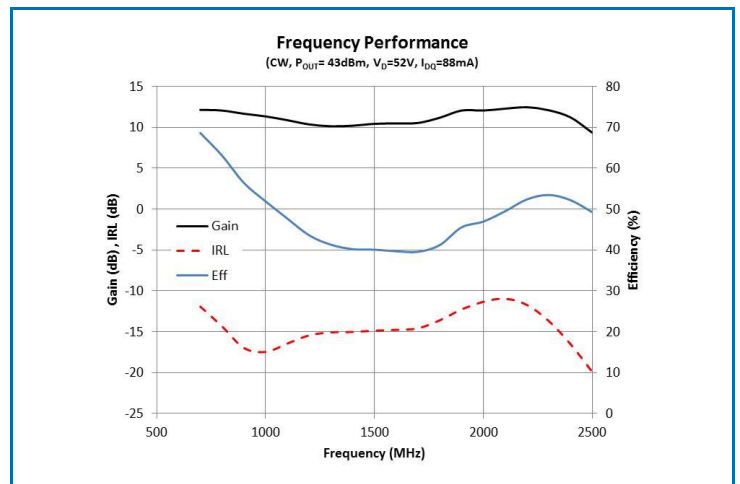
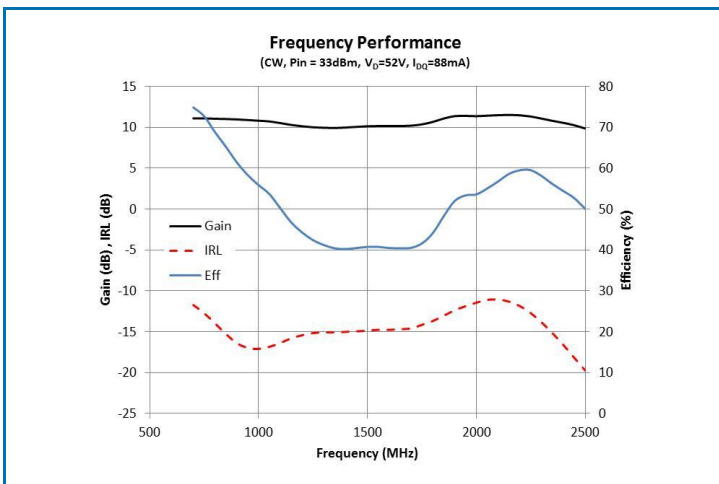
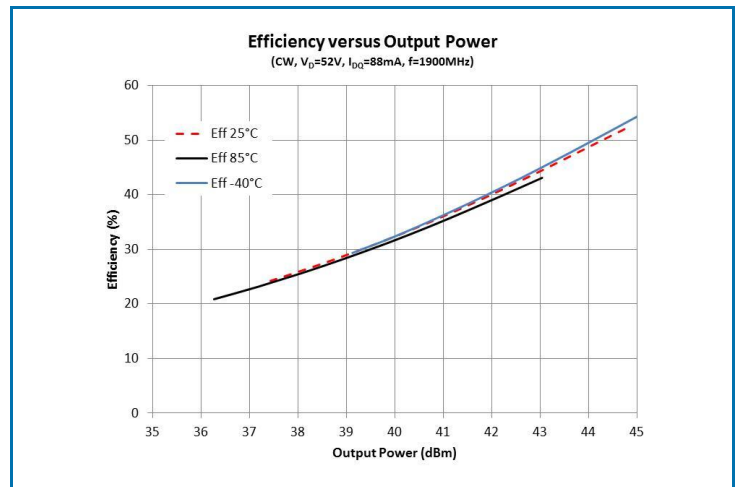
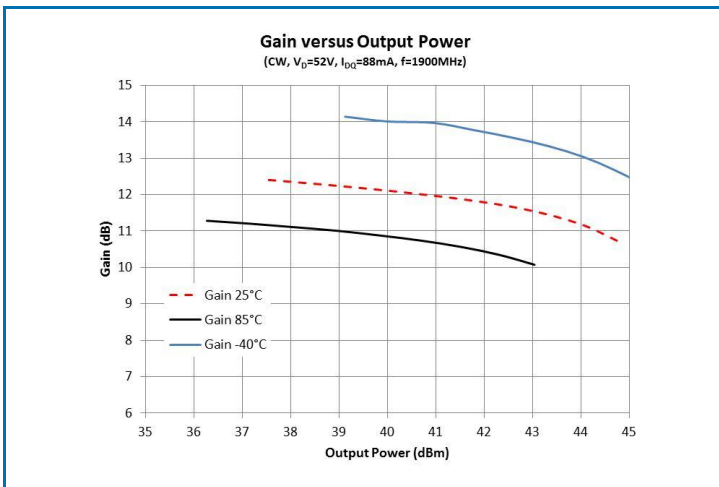
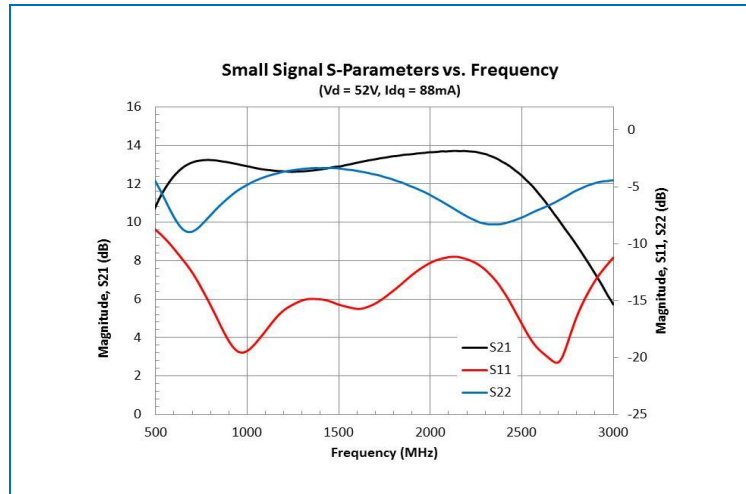

Typical Performance in standard fixed tuned test fixture matched for 700MHz to 2500MHz
 (T = 25°C, unless noted) (continued)

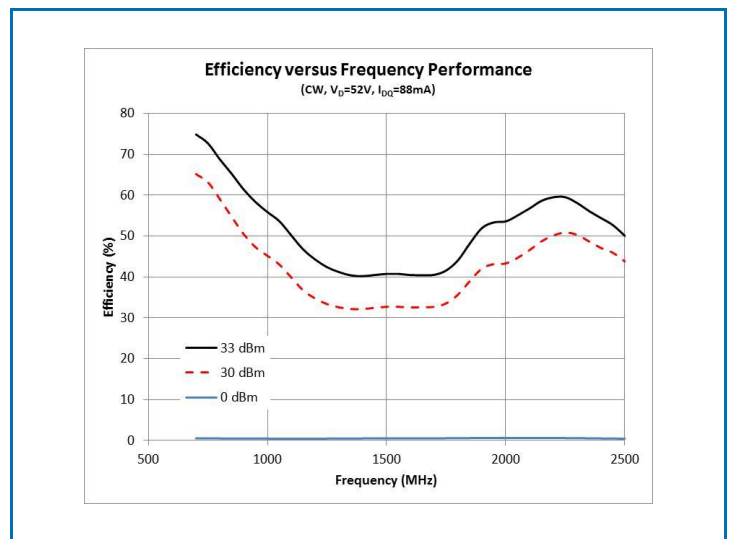
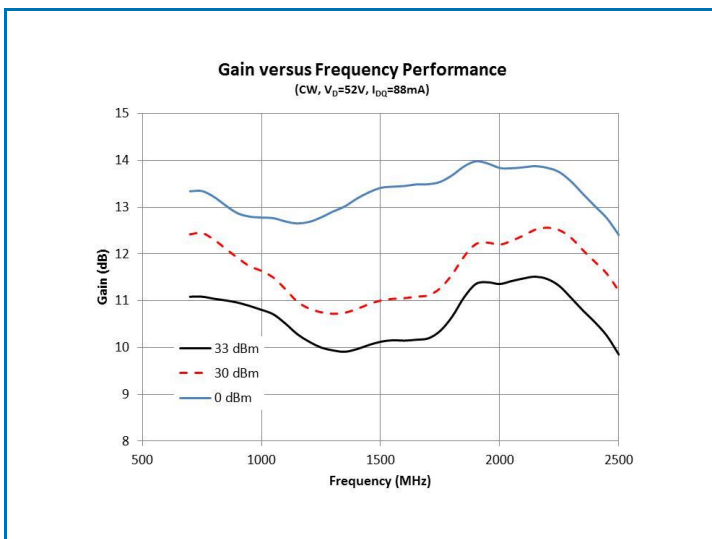
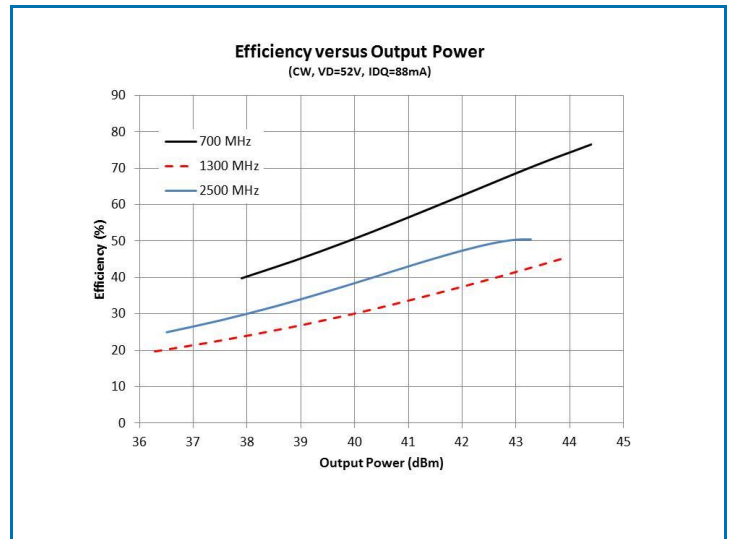
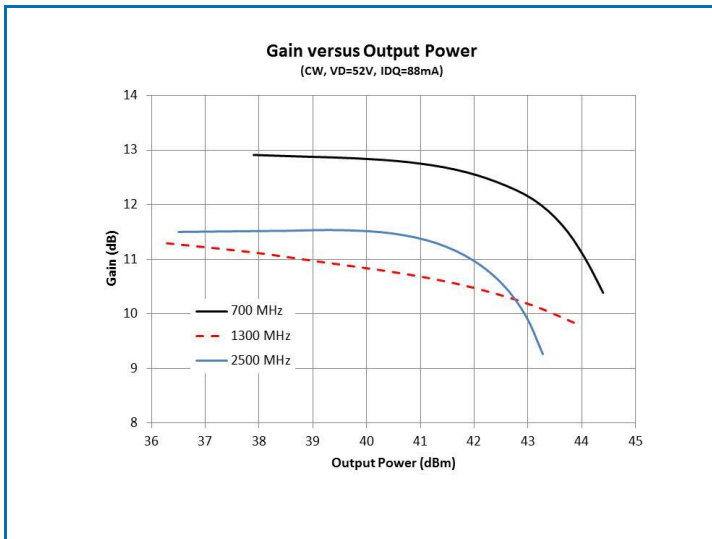

Evaluation Board Schematic

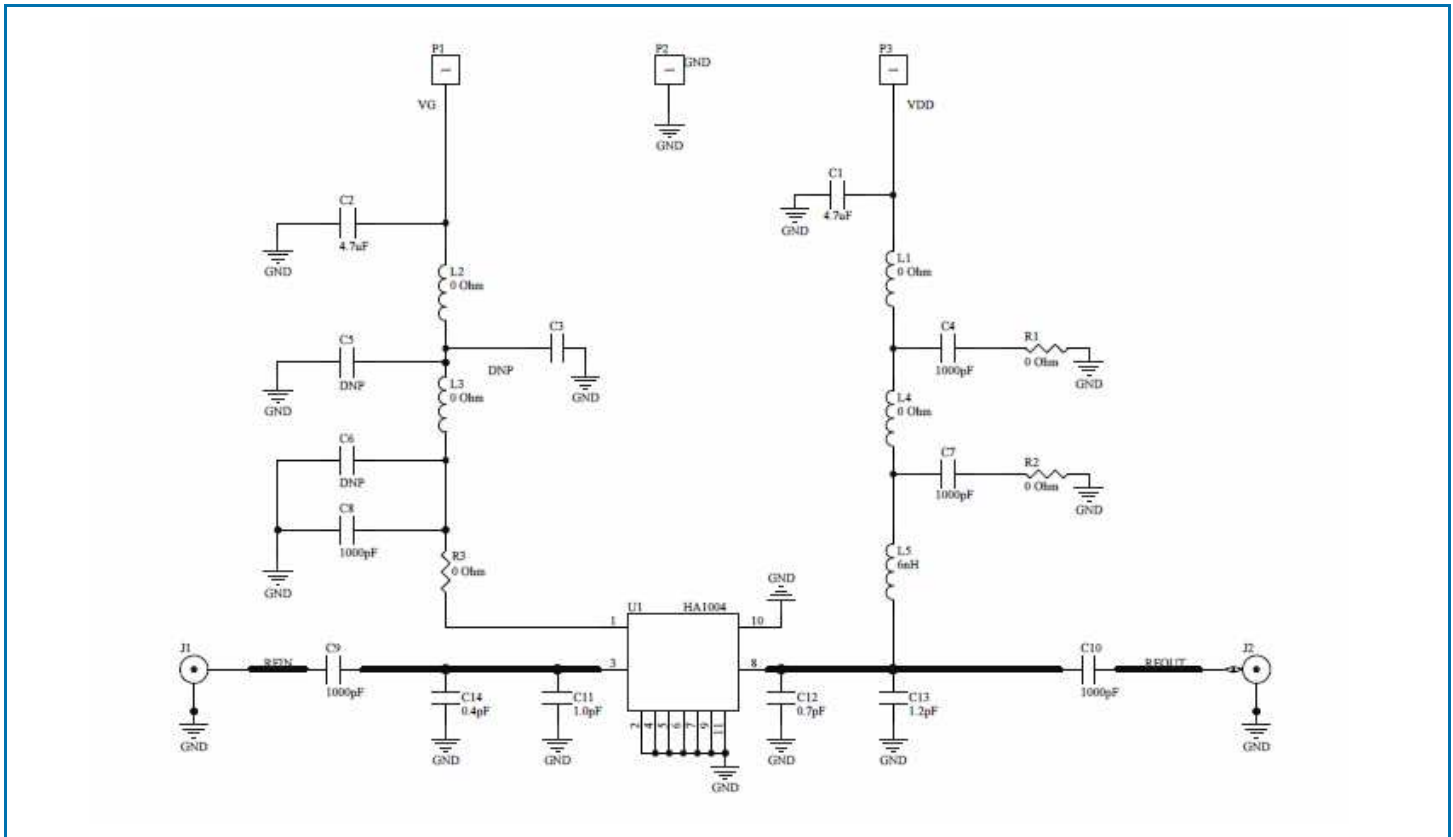

Evaluation Board Bill of Materials (BOM)*

| Item | Value | Manufacturer | Manufacturer's P/N |
|----------------|--------|-----------------------------|--------------------|
| C9,C10 | 1000pF | Dielectric Labs Inc | C08BL 102X-1ZN-X0T |
| C5 | 100pF | Panasonic Industrial Co | ECJ-1VC1H10J |
| C12 | 0.7pF | American Technical Ceramics | ATC800A0R7BT250X |
| C11 | 1.0pF | American Technical Ceramics | ATC800A1R0BT250X |
| C13 | 1.2pF | American Technical Ceramics | ATC800A1R2BT25X |
| C14 | 0.4pF | American Technical Ceramics | ATC800A0R4BT250X |
| C4,C7, C8 | 1000pF | Murata Electronics | GRM188R71H102KA01D |
| C1,C2 | 4.7 uF | Murata Electronics | GRM55ER72A475KA01L |
| R1,R2,R3 | 0Ω | Panasonic Industrial Co | ERJ-3GEY0R00V |
| L1, L2, L3, L4 | 0Ω | Panasonic Industrial Co | ERJ-8GEY0R)) |
| L5 | 0.6nH | Coilcraft | 0806SQ-6N0JLB |

*700MHz to 2500MHz RFHA1004PCBA-410

Package Drawing (Dimensions in millimeters)

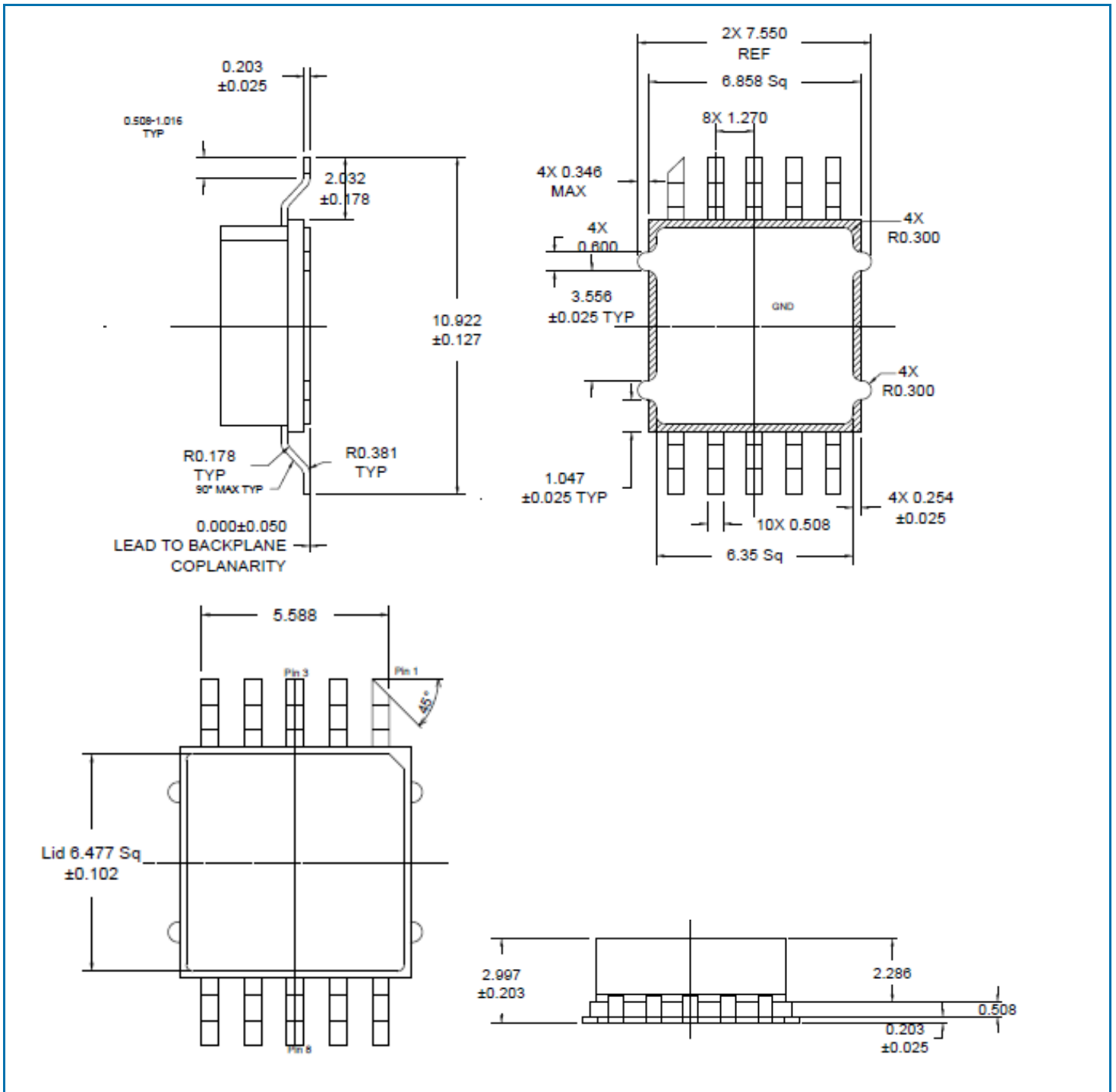

Pin Names and Descriptions

| Pin | Name | Description |
|----------|-----------|-----------------------------|
| 1 | VGS | Gate DC Bias pin |
| 2 | N/C | No Internal Connection |
| 3 | RFIN | RF Input |
| 4-7 | N/C | No Internal Connection |
| 8 | RFOUT/VDS | RF Output/Drain DC Bias pin |
| 9-10 | N/C | No Internal Connection |
| Backside | GND | Ground |

Bias Instruction for RFHA1004 Evaluation Board

- ESD Sensitive Material. Please use proper ESD precautions when handling devices of evaluation board.
 - Evaluation board requires additional external fan cooling.
 - Connect all supplies before powering evaluation board.
1. Connection RF cables at RFIN and RFOUT.
 2. Connect ground to the ground supply terminal, and ensure that both the VG and VD grounds are also connected to this ground terminal.
 3. Apply -5V to VG.
 4. Apply 52V to VD.
 5. Increase V_{G2} until drain current reaches 88mA or desired bias point.
 6. Turn on the RF input.
- Typical test data provided is measured to SMA connector reference plane, and include evaluation board/broadband bias network mismatch and losses

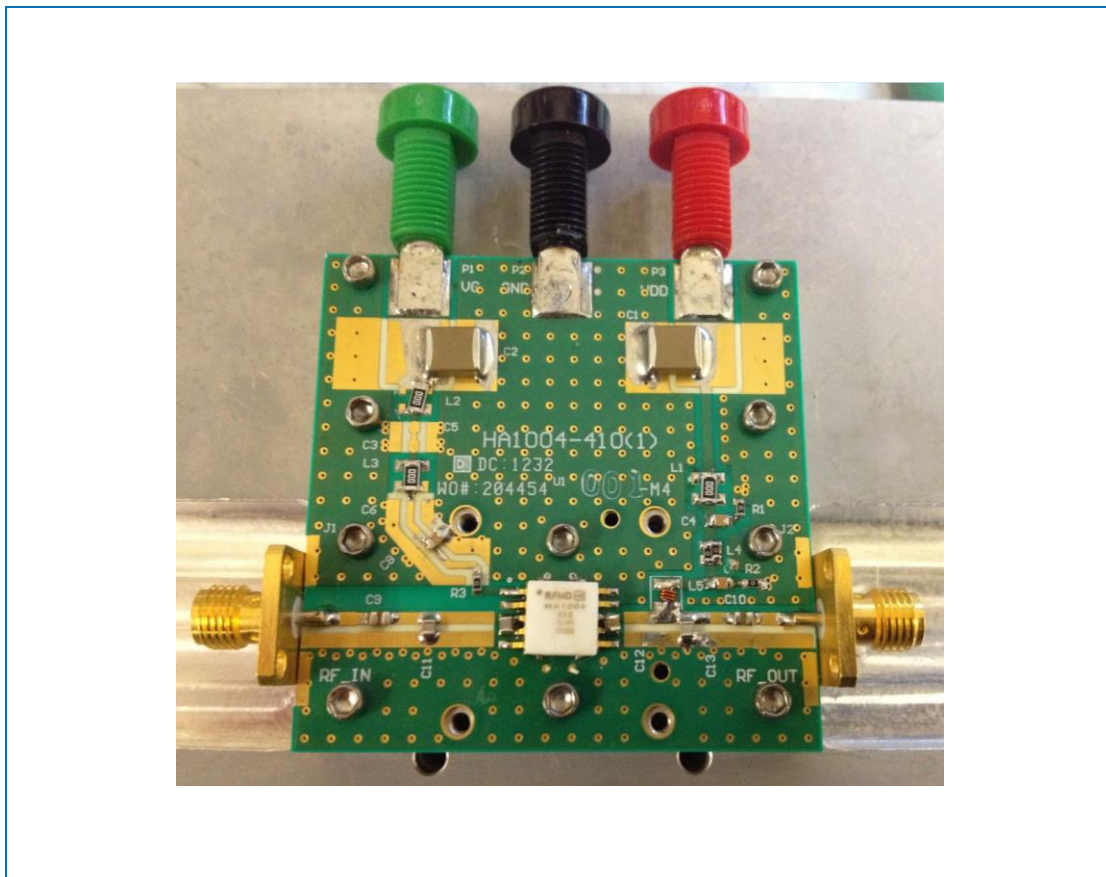

Evaluation Board Layout

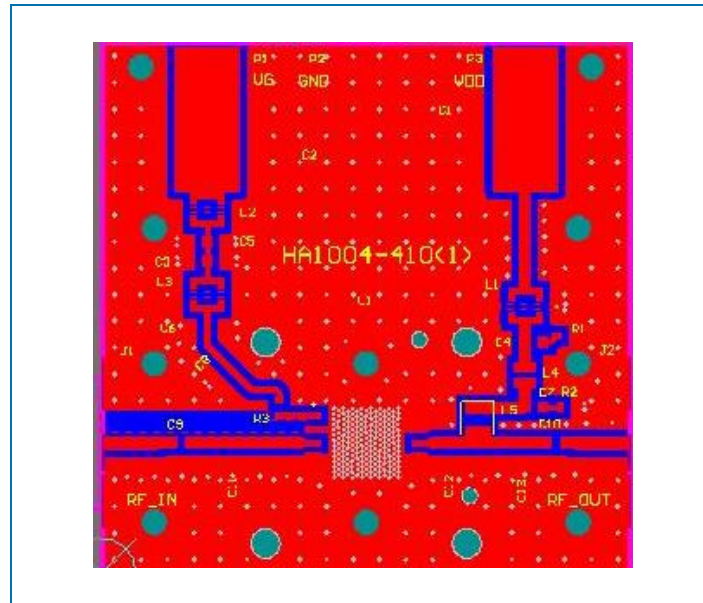

Device Impedances*

| Frequency | RFHA1004PCBA-410 (700MHz to 2500MHz) | |
|-----------|--------------------------------------|---------------------|
| | Z Source (Ω) | Z Load (Ω) |
| 700 MHz | 39.14 -j10.56 | 44.05 +j40.74 |
| 900 MHz | 34.12 - j9.62 | 60.99 +j18.87 |
| 1000 MHz | 31.74 - j8.53 | 58.14 + j7.10 |
| 1200 MHz | 27.79 - j5.35 | 44.33 - j2.37 |
| 1500 MHz | 23.51 + j0.83 | 29.51 + j2.31 |
| 1800 MHz | 21.23 + j8.04 | 23.22 +j12.81 |
| 2000 MHz | 20.71 +j13.15 | 21.75 +j20.61 |
| 2200 MHz | 20.84 +j18.44 | 22.07 +j 29.11 |
| 2500MHz | 22.70 +j26.87 | 25.72 + j44.07 |

* Device impedances reported are the measured evaluation board impedances chosen for a tradeoff of efficiency and peak power performance across the entire frequency bandwidth.

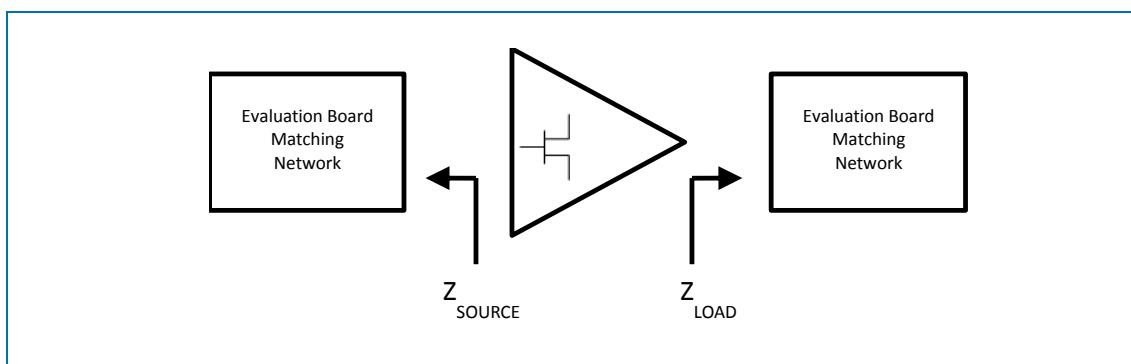

Device Handling/Environmental Conditions

RFMD does not recommend operating this device with typical drain voltage applied and the gate pinched off in a high humidity, high temperature environment.

GaN HEMT devices are ESD sensitive materials. Please use proper ESD precautions when handling devices or evaluation boards.

DC Bias

The GaN HEMT device is a depletion mode high electron mobility transistor (HEMT). At zero volts V_{GS} the drain of the device is saturated and uncontrolled drain current will destroy the transistor. The gate voltage must be taken to a potential lower than the source voltage to pinch off the device prior to applying the drain voltage, taking care not to exceed the gate voltage maximum limits. RFMD recommends applying $V_{GS} = -5V$ before applying any V_{DS} .

RF Power transistor performance capabilities are determined by the applied quiescent drain current. This drain current can be adjusted to trade off power, linearity, and efficiency characteristics of the device. The recommended quiescent drain current (I_{DQ}) shown in the RF typical performance table is chosen to best represent the operational characteristics for this device, considering manufacturing variations and expected performance. The user may choose alternate conditions for biasing this device based on performance tradeoffs.

Mounting and Thermal Considerations

The thermal resistance provided as R_{TH} (junction to case) represents only the packaged device thermal characteristics. This is measured using IR microscopy capturing the device under test temperature at the hottest spot of the die. At the same time, the package temperature is measured using a thermocouple touching the backside of the die embedded in the device heat-sink but sized to prevent the measurement system from impacting the results. Knowing the dissipated power at the time of the measurement, the thermal resistance is calculated.

In order to achieve the advertised MTTF, proper heat removal must be considered to maintain the junction at or below the maximum of 200°C. Proper thermal design includes consideration of ambient temperature and the thermal resistance from ambient to the back of the package including heat-sinking systems and air flow mechanisms. Incorporating the dissipated DC power, it is possible to calculate the junction temperature of the device.