



Chipsmall Limited consists of a professional team with an average of over 10 year of expertise in the distribution of electronic components. Based in Hongkong, we have already established firm and mutual-benefit business relationships with customers from,Europe,America and south Asia,supplying obsolete and hard-to-find components to meet their specific needs.

With the principle of "Quality Parts,Customers Priority,Honest Operation,and Considerate Service",our business mainly focus on the distribution of electronic components. Line cards we deal with include Microchip,ALPS,ROHM,Xilinx,Pulse,ON,Everlight and Freescale. Main products comprise IC,Modules,Potentiometer,IC Socket,Relay,Connector.Our parts cover such applications as commercial,industrial, and automotives areas.

We are looking forward to setting up business relationship with you and hope to provide you with the best service and solution. Let us make a better world for our industry!



Contact us

Tel: +86-755-8981 8866 Fax: +86-755-8427 6832

Email & Skype: info@chipsmall.com Web: www.chipsmall.com

Address: A1208, Overseas Decoration Building, #122 Zhenhua RD., Futian, Shenzhen, China





Powermite Low Noise 1 Watt Zener Diodes

DESCRIPTION

This Microsemi Powermite surface mount low noise Zener package series provides a higher power handling capability that are also RoHS compliant. In addition to its size advantages, Powermite package features include a full-metallic bottom that eliminates the possibility of solder flux entrapment during assembly, and a unique locking tab acts as an efficient heat path from die to mounting plane for external heat sinking with very low thermal resistance junction to case (bottom). Its innovative design makes this device ideal for use with automatic insertion equipment.

Important: For the latest information, visit our website <http://www.microsemi.com>.

FEATURES

- Surface mount equivalent to JEDEC registered 1N4099 through 1N4135 and 1N4614 through 1N4627 series except with additional power capability.
- Extensive selection from 1.8 to 100 volts.
- Regulates voltage over a broad operating current and temperature range.
- Low $R_{\theta JC}$ for cooler operation and better voltage regulation.
- Low noise density (1-3 kHz) at test current.
- Low reverse leakage current.
- RoHS compliant by design.

APPLICATIONS / BENEFITS

- Tight tolerances available in plus or minus 2%.
- Moisture classification Level 1 per IPC/JEDEC J-STD-020B with no dry pack required.
- Non-sensitive to ESD per MIL-STD-750 method 1020.
- Compatible with automatic insertion equipment.
- Full metallic bottom eliminates flux entrapment.

MAXIMUM RATINGS

Parameters/Test Conditions	Symbol	Value	Unit
Junction and Storage Temperature	T_J and T_{STG}	-55 to +150	°C
Thermal Resistance Junction-to-Ambient ⁽¹⁾	$R_{\theta JA}$	240	°C/W
Thermal Resistance Junction-to-Case	$R_{\theta JC}$	30	°C/W
Steady-State Power Dissipation ⁽²⁾	P_D	1.0	W
Forward Voltage @ 200 mA	V_F	1.1	V
Solder Temperature @ 10 s	T_{SP}	260	°C

- Notes:**
1. On FR4 PC board (1 oz copper) with recommended footprint (see [last page](#)).
 2. At $T_C \leq 120^\circ\text{C}$ where T_C is case bottom temperature at mounting plane, or 0.5 watts at $T_A = 30^\circ\text{C}$ (ambient temperature) when mounted on FR4 PC board as described for $R_{\theta JA}$ (also see power deratings in [figure 2](#)).

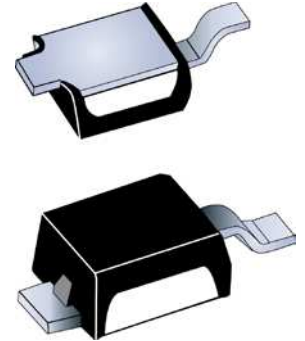

DO-216 Package

Also available in:

 **DO-35 package**
(axial-leaded)
[1N4099 – 1N4135 and 1N4614 – 1N4627](#)

 **DO-213AA package**
(surface mount)
[1N4099UR – 1N4135UR and 1N4614UR – 1N4627UR](#)

MSC – Lawrence

6 Lake Street,
Lawrence, MA 01841
Tel: 1-800-446-1158 or
(978) 620-2600
Fax: (978) 689-0803

MSC – Ireland

Gort Road Business Park,
Ennis, Co. Clare, Ireland
Tel: +353 (0) 65 6840044
Fax: +353 (0) 65 6822298

Website:

www.microsemi.com

MECHANICAL and PACKAGING

- CASE: Void-free transfer molded thermosetting epoxy compound meeting UL94V-0.
- FINISH: Annealed matte-tin plating over copper and readily solderable per MIL-STD-750 method 2026. (Consult factory for tin-lead plating. NOTE: Tin-lead plated product is not RoHS compliant.)
- POLARITY: Cathode designated by Tab 1 (bottom).
- TAPE AND REEL option: Standard per EIA-481-B (consult factory for quantities).
- MARKING: Three numerical digits of P/N and a dot (see [electrical characteristics](#)).
- WEIGHT: Approximately 0.016 grams.
- See [package dimensions](#) on last page.

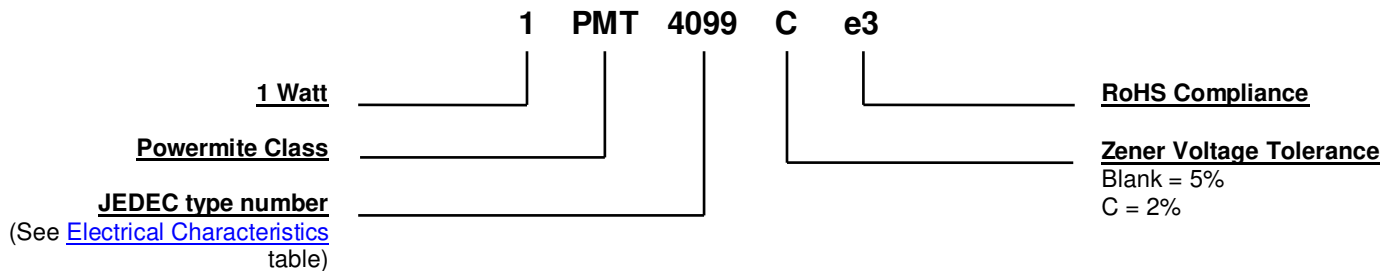
PART NOMENCLATURE

SYMBOLS & DEFINITIONS

Symbol	Definition
I_R	Reverse Current: The maximum reverse (leakage) current that will flow at the specified voltage and temperature.
I_Z, I_{ZT}, I_{ZK}	Regulator Current: The dc regulator current (I_Z), at a specified test point (I_{ZT}), near breakdown knee (I_{ZK}).
I_{ZM}	Maximum Regulator (Zener) Current: The maximum rated dc current for the specified power rating.
N_D	Noise Density: The noise generated over a specified frequency bandwidth usually specified in terms of mV/ $\sqrt{\text{Hz}}$.
V_R	Reverse Voltage: The reverse voltage dc value, no alternating component.
V_Z	Zener Voltage: The Zener voltage the device will exhibit at a specified current (I_Z) in its breakdown region.
Z_{ZT} or Z_{ZK}	Dynamic Impedance: The small signal impedance of the diode when biased to operate in its breakdown region at a specified rms current modulation (typically 10% of I_{ZT} or I_{ZK}) and superimposed on I_{ZT} or I_{ZK} respectively.

ELECTRICAL CHARACTERISTICS @ 25 °C unless otherwise stated

PART NUMBER (Note 4)	DEVICE MARKING	NOMINAL ZENER VOLTAGE (Note 1) $V_Z @ I_{ZT}$	ZENER TEST CURRENT I_{ZT}	MAXIMUM ZENER IMPEDANCE (Note 2) Z_{ZT}	MAXIMUM REVERSE CURRENT $I_R @ V_R$		MAXIMUM NOISE DENSITY $N_D @ I_{ZT}$	MAXIMUM ZENER CURRENT (Note 3) I_{ZM}	MAXIMUM TEMPERATURE COEFFICIENT OF ZENER VOLTAGE α_{VZ}
		Volts	μA	Ohms	μA	Volts	$\mu V/\sqrt{HZ}$	mA	%/°C
1PMT4614	614•	1.8	250	1200	10	1.0	1	262.4	-0.075
1PMT4615	615•	2.0	250	1250	5.0	1.0	1	240.6	-0.075
1PMT4616	616•	2.2	250	1300	4.0	1.0	1	218.7	-0.075
1PMT4617	617•	2.4	250	1400	2.0	1.0	1	207.8	-0.075
1PMT4618	618•	2.7	250	1500	1.0	1.0	1	196.8	-0.075
1PMT4619	619•	3.0	250	1600	0.8	1.0	1	190.3	-0.075
1PMT4620	620•	3.3	250	1650	7.5	1.5	1	185.9	-0.075
1PMT4621	621•	3.6	250	1700	7.5	2.0	1	181.5	-0.065
1PMT4622	622•	3.9	250	1650	5.0	2.0	1	174.9	-0.060
1PMT4623	623•	4.3	250	1650	4.0	2.0	1	168.4	-0.050
1PMT4624	624•	4.7	250	1600	10	3.0	1	164.0	-0.040 +0.020
1PMT4625	625•	5.1	250	1500	10	3.0	2	153.1	-0.045 +0.030
1PMT4626	626•	5.6	250	1400	10	4.0	4	142.2	-0.020 +0.040
1PMT4627	627•	6.2	250	1200	10	5.0	5	133.4	-0.010 +0.050
1PMT4099	099•	6.8	250	200	10	5.17	40	122.5	0.040
1PMT4100	100•	7.5	250	200	10	5.70	40	111.5	0.045
1PMT4101	101•	8.2	250	200	1	6.24	40	100.6	0.048
1PMT4102	102•	8.7	250	200	1	6.61	40	96.2	0.049
1PMT4103	103•	9.1	250	200	1	6.92	40	91.9	0.050
1PMT4104	104•	10	250	200	1	7.60	40	83.1	0.055
1PMT4105	105•	11	250	200	.05	8.44	40	76.5	0.060
1PMT4106	106•	12	250	200	.05	9.12	40	69.9	0.065
1PMT4107	107•	13	250	200	.05	9.87	40	63.4	0.065
1PMT4108	108•	14	250	200	.05	10.65	40	59.0	0.070
1PMT4109	109•	15	250	100	.05	11.40	40	54.8	0.070
1PMT4110	110•	16	250	100	.05	12.15	40	52.5	0.070
1PMT4111	111•	17	250	100	.05	12.92	40	48.1	0.075
1PMT4112	112•	18	250	100	.05	13.37	40	45.9	0.075
1PMT4113	113•	19	250	150	.05	14.44	40	43.7	0.075
1PMT4114	114•	20	250	150	.01	15.20	40	41.6	0.075
1PMT4115	115•	22	250	150	.01	16.72	40	37.2	0.080
1PMT4116	116•	24	250	150	.01	18.25	40	34.9	0.080
1PMT4117	117•	25	250	150	.01	19.00	40	32.8	0.080
1PMT4118	118•	27	250	150	.01	20.45	40	30.6	0.085
1PMT4119	119•	28	250	200	.01	21.28	40	30.6	0.085
1PMT4120	120•	30	250	200	.01	22.80	40	28.4	0.085
1PMT4121	121•	33	250	200	.01	25.08	40	26.2	0.085
1PMT4122	122•	36	250	200	.01	27.38	40	24.0	0.090
1PMT4123	123•	39	250	200	.01	29.65	40	21.4	0.090
1PMT4124	124•	43	250	250	.01	32.65	40	19.5	0.090
1PMT4125	125•	47	250	250	.01	35.75	40	17.7	0.090
1PMT4126	126•	51	250	300	.01	38.76	40	16.4	0.090
1PMT4127	127•	56	250	300	.01	42.60	40	14.7	0.090
1PMT4128	128•	60	250	400	.01	45.60	40	13.9	0.090
1PMT4129	129•	62	250	500	.01	47.10	40	13.3	0.090
1PMT4130	130•	68	250	700	.01	51.68	40	12.2	0.095
1PMT4131	131•	75	250	700	.01	57.00	40	11.2	0.095
1PMT4132	132•	82	250	800	.01	62.32	40	10.1	0.095
1PMT4133	133•	87	250	1000	.01	66.12	40	9.6	0.095
1PMT4134	134•	91	250	1200	.01	69.16	40	9.2	0.095
1PMT4135	135•	100	250	1500	.01	76.00	40	8.3	0.095

NOTE 1: Product shown has a standard tolerance of $\pm 5\%$ on the nominal Zener voltage. V_Z is measured at I_{ZT} with T_c (TAB 1) at 30 °C.

NOTE 2: Zener impedance is derived by superimposing on I_{ZT} a 60 Hz rms ac current equal to 10% of I_{ZT} (25 μA ac).

NOTE 3: Based on 1 W maximum power dissipation before any derating. Allowance has been made for higher voltage with operation at higher currents and temperature. For determination of voltage change with current deviations from I_{ZT} see [MicroNote 202](#).

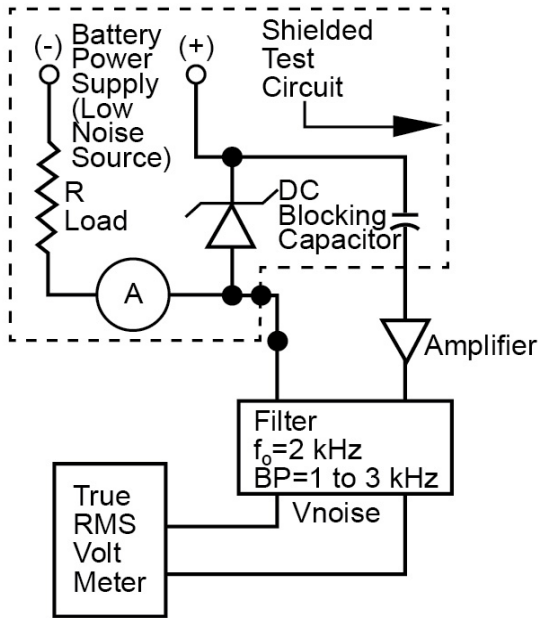
GRAPHS

FIGURE 1 – Noise Density Measurement Circuit

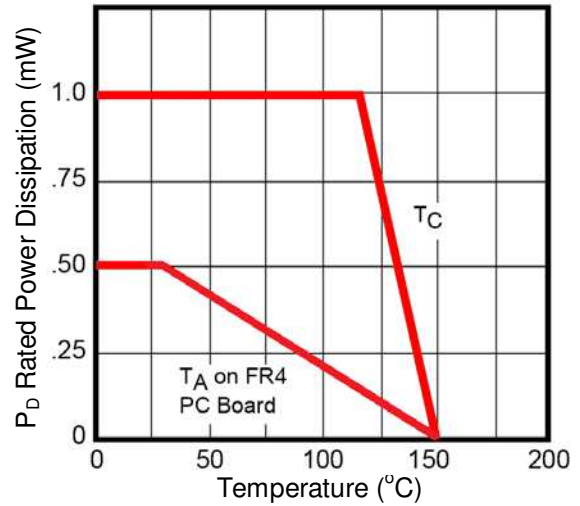
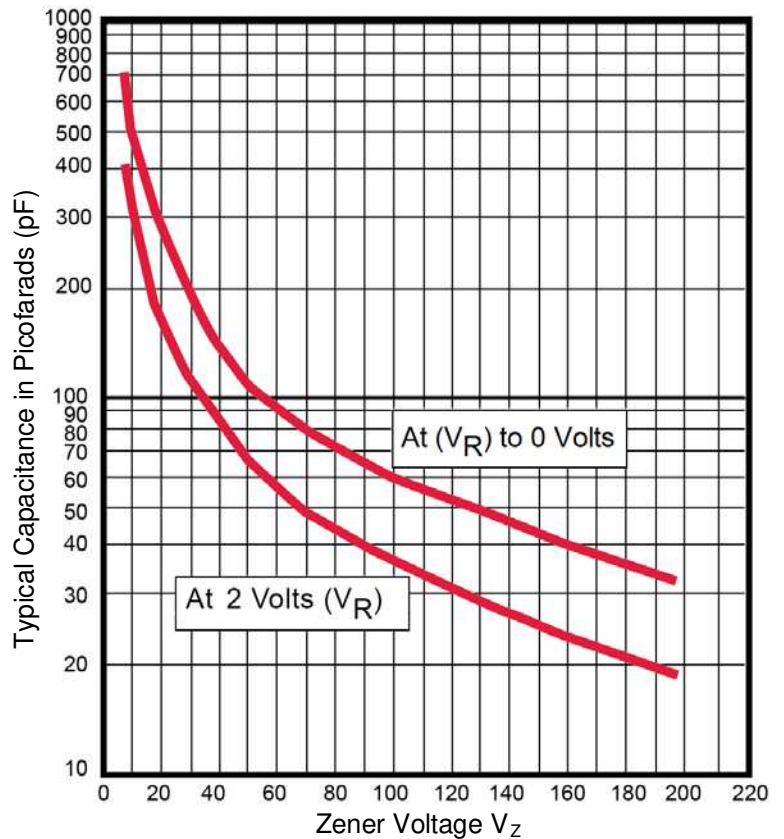
Noise density, (N_D) is specified in microvolt-rms per square-root-hertz. Actual measurement is performed using a 1 kHz to 3 kHz frequency bandpass filter at a constant Zener test current (I_{ZT}) at 25 °C ambient temperature. N_D is calculated from the formula.

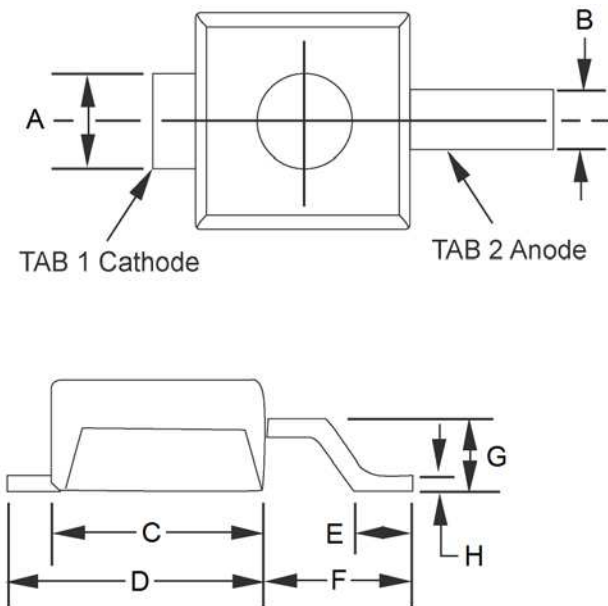
FIGURE 2 - Power Derating Curve
 Where T_C is case (bottom) temperature and T_A is Ambient Temperature on FR4 PC board.

FIGURE 3 – Capacitance vs. Zener Voltage (Typical)

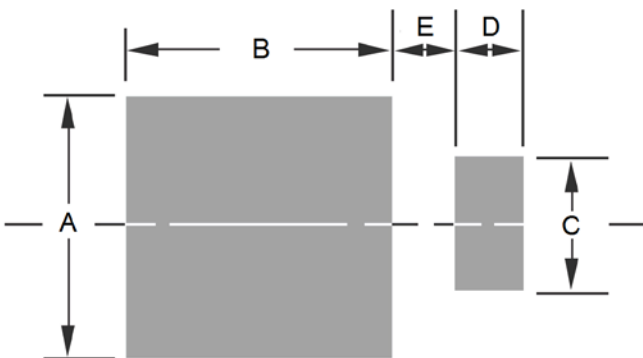
PACKAGE DIMENSIONS

Ltr	Dimensions			
	Inch		Millimeters	
	Min	Max	Min	Max
A	0.029	0.039	0.73	0.99
B	0.016	0.026	0.40	0.66
C	0.070	0.080	1.77	2.03
D	0.087	0.097	2.21	2.46
E	0.020	0.030	0.50	0.76
F	0.051	0.061	1.29	1.54
G	0.021	0.031	0.53	0.78
H	0.004	0.008	0.10	0.20
J	0.070	0.080	1.77	2.03
K	0.035	0.045	0.89	1.14

PAD LAYOUT

Ltr	Dimensions	
	Inch	Millimeters
A	0.100	2.54
B	0.105	2.67
C	0.050	1.27
D	0.030	0.76
E	0.025	0.64