



Chipsmall Limited consists of a professional team with an average of over 10 year of expertise in the distribution of electronic components. Based in Hongkong, we have already established firm and mutual-benefit business relationships with customers from,Europe,America and south Asia,supplying obsolete and hard-to-find components to meet their specific needs.

With the principle of “Quality Parts,Customers Priority,Honest Operation,and Considerate Service”,our business mainly focus on the distribution of electronic components. Line cards we deal with include Microchip,ALPS,ROHM,Xilinx,Pulse,ON,Everlight and Freescale. Main products comprise IC,Modules,Potentiometer,IC Socket,Relay,Connector.Our parts cover such applications as commercial,industrial, and automotives areas.

We are looking forward to setting up business relationship with you and hope to provide you with the best service and solution. Let us make a better world for our industry!



## Contact us

Tel: +86-755-8981 8866 Fax: +86-755-8427 6832

Email & Skype: info@chipsmall.com Web: www.chipsmall.com

Address: A1208, Overseas Decoration Building, #122 Zhenhua RD., Futian, Shenzhen, China



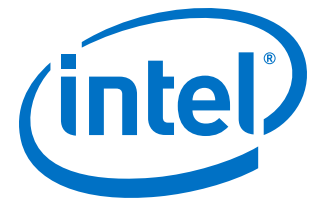

# Stratix 10 GX/SX Device Overview

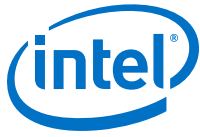

## Contents

---

<b>1. Intel® Stratix® 10 GX/SX Device Overview.....</b>	<b>3</b>
1.1. Intel Stratix 10 Family Variants.....	4
1.1.1. Available Options.....	6
1.2. Innovations in Intel Stratix 10 FPGAs and SoCs.....	6
1.3. FPGA and SoC Features Summary.....	8
1.4. Intel Stratix 10 Block Diagram.....	11
1.5. Intel Stratix 10 FPGA and SoC Family Plan.....	11
1.6. HyperFlex Core Architecture.....	15
1.7. Heterogeneous 3D SiP Transceiver Tiles.....	16
1.8. Intel Stratix 10 Transceivers.....	17
1.8.1. PMA Features.....	18
1.8.2. PCS Features.....	20
1.9. PCI Express Gen1/Gen2/Gen3 Hard IP.....	21
1.10. Interlaken PCS Hard IP.....	21
1.11. 10G Ethernet Hard IP.....	22
1.12. External Memory and General Purpose I/O.....	22
1.13. Adaptive Logic Module (ALM).....	23
1.14. Core Clocking.....	24
1.15. Fractional Synthesis PLLs and I/O PLLs.....	25
1.16. Internal Embedded Memory.....	25
1.17. Variable Precision DSP Block.....	25
1.18. Hard Processor System (HPS).....	28
1.18.1. Key Features of the Intel Stratix 10 HPS.....	29
1.19. Power Management.....	32
1.20. Device Configuration and Secure Device Manager (SDM).....	32
1.21. Device Security.....	34
1.22. Configuration via Protocol Using PCI Express.....	34
1.23. Partial and Dynamic Reconfiguration.....	35
1.24. Fast Forward Compile.....	35
1.25. Single Event Upset (SEU) Error Detection and Correction.....	35
1.26. Document Revision History for the Intel Stratix 10 GX/SX Device Overview.....	36

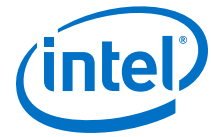

## 1. Intel® Stratix® 10 GX/SX Device Overview

---

Intel's 14-nm Intel® Stratix® 10 GX FPGAs and SX SoCs deliver 2X the core performance and up to 70% lower power over previous generation high-performance FPGAs.

Featuring several groundbreaking innovations, including the all new HyperFlex™ core architecture, this device family enables you to meet the demand for ever-increasing bandwidth and processing performance in your most advanced applications, while meeting your power budget.

With an embedded hard processor system (HPS) based on a quad-core 64-bit ARM® Cortex®-A53, the Intel Stratix 10 SoC devices deliver power efficient, application-class processing and allow designers to extend hardware virtualization into the FPGA fabric. Intel Stratix 10 SoC devices demonstrate Intel's commitment to high-performance SoCs and extend Intel's leadership in programmable devices featuring an ARM-based processor system.

Important innovations in Intel Stratix 10 FPGAs and SoCs include:

- All new HyperFlex core architecture delivering 2X the core performance compared to previous generation high-performance FPGAs
- Industry leading Intel 14-nm Tri-Gate (FinFET) technology
- Heterogeneous 3D System-in-Package (SiP) technology
- Monolithic core fabric with up to 5.5 million logic elements (LEs)
- Up to 96 full duplex transceiver channels on heterogeneous 3D SiP transceiver tiles
- Transceiver data rates up to 28.3 Gbps chip-to-chip/module and backplane performance
- M20K (20 kbit) internal SRAM memory blocks
- Fractional synthesis and ultra-low jitter LC tank based transmit phase locked loops (PLLs)
- Hard PCI Express® Gen3 x16 intellectual property (IP) blocks
- Hard 10GBASE-KR/40GBASE-KR4 Forward Error Correction (FEC) in every transceiver channel
- Hard memory controllers and PHY supporting DDR4 rates up to 2666 Mbps per pin
- Hard fixed-point and IEEE 754 compliant hard floating-point variable precision digital signal processing (DSP) blocks with up to 10 TFLOPS compute performance with a power efficiency of 80 GFLOPS per Watt
- Quad-core 64-bit ARM Cortex-A53 embedded processor running up to 1.5 GHz in SoC family variants
- Programmable clock tree synthesis for flexible, low power, low skew clock trees

---

Intel Corporation. All rights reserved. Intel, the Intel logo, Altera, Arria, Cyclone, Enpirion, MAX, Nios, Quartus and Stratix words and logos are trademarks of Intel Corporation or its subsidiaries in the U.S. and/or other countries. Intel warrants performance of its FPGA and semiconductor products to current specifications in accordance with Intel's standard warranty, but reserves the right to make changes to any products and services at any time without notice. Intel assumes no responsibility or liability arising out of the application or use of any information, product, or service described herein except as expressly agreed to in writing by Intel. Intel customers are advised to obtain the latest version of device specifications before relying on any published information and before placing orders for products or services.

\*Other names and brands may be claimed as the property of others.

ISO  
9001:2015  
Registered

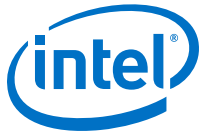

- Dedicated secure device manager (SDM) for:
  - Enhanced device configuration and security
  - AES-256, SHA-256/384 and ECDSA-256/384 encrypt/decrypt accelerators and authentication
  - Multi-factor authentication
  - Physically Unclonable Function (PUF) service and software programmable device configuration capability
- Comprehensive set of advanced power saving features delivering up to 70% lower power compared to previous generation high-performance FPGAs
- Non-destructive register state readback and writeback, to support ASIC prototyping and other applications

With these capabilities, Intel Stratix 10 FPGAs and SoCs are ideally suited for the most demanding applications in diverse markets such as:

- **Compute and Storage**—for custom servers, cloud computing and data center acceleration
- **Networking**—for Terabit, 400G and multi-100G bridging, aggregation, packet processing and traffic management
- **Optical Transport Networks**—for OTU4, 2xOTU4, 4xOTU4
- **Broadcast**—for high-end studio distribution, headend encoding/decoding, edge quadrature amplitude modulation (QAM)
- **Military**—for radar, electronic warfare, and secure communications
- **Medical**—for diagnostic scanners and diagnostic imaging
- **Test and Measurement**—for protocol and application testers
- **Wireless**—for next-generation 5G networks
- **ASIC Prototyping**—for designs that require the largest monolithic FPGA fabric with the highest I/O count

## 1.1. Intel Stratix 10 Family Variants

Intel Stratix 10 devices are available in FPGA (GX) and SoC (SX) variants.

- **Intel Stratix 10 GX** devices deliver up to 1 GHz core fabric performance and contain up to 5.5 million LEs in a monolithic fabric. They also feature up to 96 general purpose transceivers on separate transceiver tiles, and 2666 Mbps DDR4 external memory interface performance. The transceivers are capable of up to 28.3 Gbps short reach and across the backplane. These devices are optimized for FPGA applications that require the highest transceiver bandwidth and core fabric performance, with the power efficiency of Intel's industry-leading 14-nm Tri-Gate process technology.
- **Intel Stratix 10 SX** devices have a feature set that is identical to Intel Stratix 10 GX devices, with the addition of an embedded quad-core 64-bit ARM Cortex A53 hard processor system.

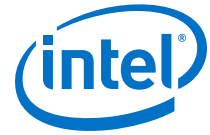

Common to all Intel Stratix 10 family variants is a high-performance fabric based on the new HyperFlex core architecture that includes additional Hyper-Registers throughout the interconnect routing and at the inputs of all functional blocks. The core fabric also contains an enhanced logic array utilizing Intel's adaptive logic module (ALM) and a rich set of high performance building blocks including:

- M20K (20 kbit) embedded memory blocks
- Variable precision DSP blocks with hard IEEE 754 compliant floating-point units
- Fractional synthesis and integer PLLs
- Hard memory controllers and PHY for external memory interfaces
- General purpose IO cells

To clock these building blocks, Intel Stratix 10 devices use programmable clock tree synthesis, which uses dedicated clock tree routing to synthesize only those branches of the clock trees required for the application. All devices support in-system, fine-grained partial reconfiguration of the logic array, allowing logic to be added and subtracted from the system while it is operating.

All family variants also contain high speed serial transceivers, containing both the physical medium attachment (PMA) and the physical coding sublayer (PCS), which can be used to implement a variety of industry standard and proprietary protocols. In addition to the hard PCS, Intel Stratix 10 devices contain multiple instantiations of PCI Express hard IP that supports Gen1/Gen2/Gen3 rates in x1/x2/x4/x8/x16 lane configurations, and hard 10GBASE-KR/40GBASE-KR4 FEC for every transceiver. The hard PCS, FEC, and PCI Express IP free up valuable core logic resources, save power, and increase your productivity.

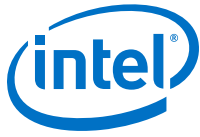

### 1.1.1. Available Options

Figure 1. Sample Ordering Code and Available Options for Intel Stratix 10 Devices

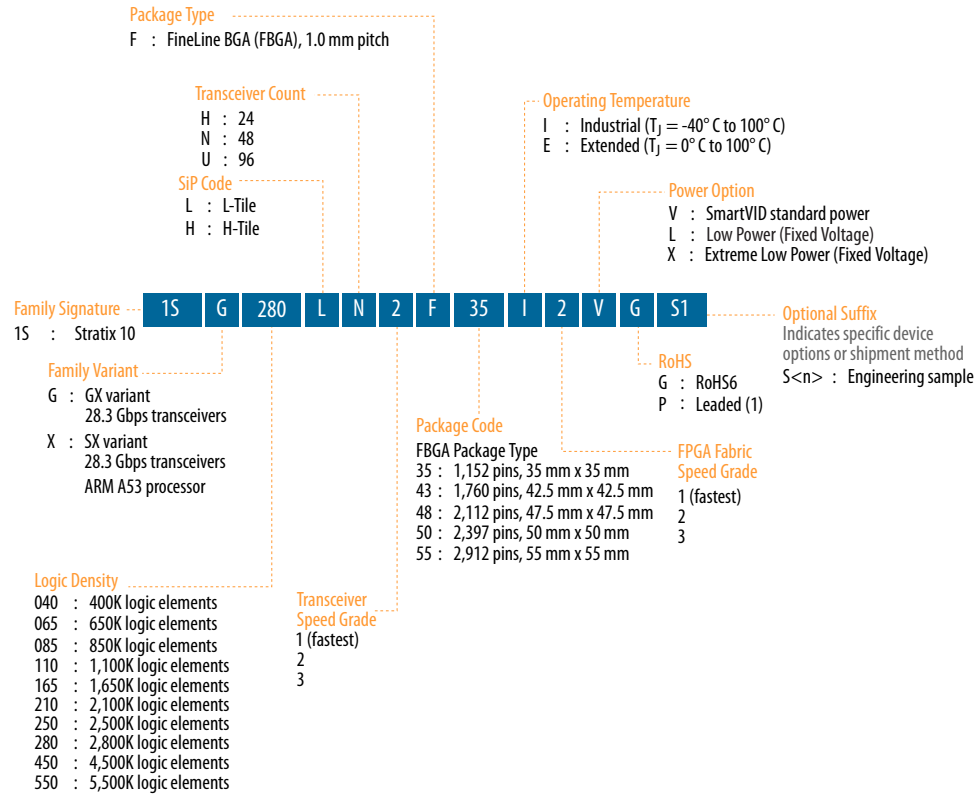

Note:  
1. Contact Intel for availability

## 1.2. Innovations in Intel Stratix 10 FPGAs and SoCs

Intel Stratix 10 FPGAs and SoCs deliver many significant improvements over the previous generation high-performance Stratix V FPGAs.

Table 1. Key Features of Intel Stratix 10 Devices Compared to Stratix V Devices

Feature	Stratix V FPGAs	Intel Stratix 10 FPGAs and SoCs
<b>Process technology</b>	28-nm TSMC (planar transistor)	14 nm Intel Tri-Gate (FinFET)
<b>Hard processor core</b>	None	Quad-core 64-bit ARM Cortex-A53 (SoC only)
<b>Core architecture</b>	Conventional core architecture with conventional interconnect	HyperFlex core architecture with Hyper-Registers in the interconnect
<b>Core performance</b>	500 MHz	1 GHz
<b>Power dissipation</b>	1x	As low as 0.3x

*continued...*

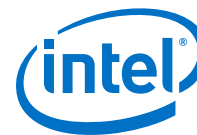

Feature	Stratix V FPGAs	Intel Stratix 10 FPGAs and SoCs
<b>Logic density</b>	952 KLE (monolithic)	5,500 KLE (monolithic)
<b>Embedded memory (M20K)</b>	52 Mbits	229 Mbits
<b>18x19 multipliers</b>	3,926 <i>Note:</i> Multiplier is 18x18 in Stratix V devices.	11,520 <i>Note:</i> Multiplier is 18x19 in Intel Stratix 10 devices.
<b>Floating point DSP capability</b>	Up to 1 TFLOP, requires soft floating point adder and multiplier	Up to 10 TFLOPS, hard IEEE 754 compliant single precision floating point adder and multiplier
<b>Maximum transceivers</b>	66	96
<b>Maximum transceiver data rate (chip-to-chip)</b>	28.05 Gbps	28.3 Gbps L-Tile 28.3 Gbps H-Tile
<b>Maximum transceiver data rate (backplane)</b>	12.5 Gbps	12.5 Gbps L-Tile 28.3 Gbps H-Tile
<b>Hard memory controller</b>	None	DDR4 @ 1333 MHz/2666 Mbps DDR3 @ 1067 MHz/2133 Mbps
<b>Hard protocol IP</b>	PCIe Gen3 x8 (up to 4 instances)	PCIe Gen3 x16 (up to 4 instances) SR-IOV (4 physical functions / 2k virtual functions) on H-Tile devices 10GBASE-KR/40GBASE-KR4 FEC
<b>Core clocking and PLLs</b>	Global, quadrant and regional clocks supported by fractional-synthesis fPLLs	Programmable clock tree synthesis supported by fractional-synthesis fPLLs and integer IO PLLs
<b>Register state readback and writeback</b>	Not available	Non-destructive register state readback and writeback for ASIC prototyping and other applications

These innovations result in the following improvements:

- **Improved Core Logic Performance:** The HyperFlex core architecture combined with Intel's 14-nm Tri-Gate technology allows Intel Stratix 10 devices to achieve 2X the core performance compared to the previous generation
- **Lower Power:** Intel Stratix 10 devices use up to 70% lower power compared to the previous generation, enabled by 14-nm Intel Tri-Gate technology, the HyperFlex core architecture, and optional power saving features built into the architecture
- **Higher Density:** Intel Stratix 10 devices offer over five times the level of integration, with up to 5,500K logic elements (LEs) in a monolithic fabric, over 229 Mbits of embedded memory blocks (M20K), and 11,520 18x19 multipliers
- **Embedded Processing:** Intel Stratix 10 SoCs feature a Quad-Core 64-bit ARM Cortex-A53 processor optimized for power efficiency and software compatible with previous generation Arria and Cyclone SoC devices
- **Improved Transceiver Performance:** With up to 96 transceiver channels implemented in heterogeneous 3D SiP transceiver tiles, Intel Stratix 10 GX and SX devices support data rates up to 28.3 Gbps chip-to-chip and 28.3 Gbps across the backplane with signal conditioning circuits capable of equalizing over 30 dB of system loss
- **Improved DSP Performance:** The variable precision DSP block in Intel Stratix 10 devices features hard fixed and floating point capability, with up to 10 TeraFLOPS IEEE754 single-precision floating point performance



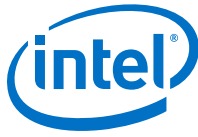

- **Additional Hard IP:** Intel Stratix 10 devices include many more hard IP blocks than previous generation devices, with a hard memory controller included in each bank of 48 general purpose IOs, a hard PCIe Gen3 x16 full protocol stack in each transceiver tile, and a hard 10GBASE-KR/40GBASE-KR4 FEC in every transceiver channel
- **Enhanced Core Clocking:** Intel Stratix 10 devices feature programmable clock tree synthesis; clock trees are only synthesized where needed, increasing the flexibility and reducing the power dissipation of the clocking solution
- **Additional Core PLLs:** The core fabric in Intel Stratix 10 devices is supported by both integer IO PLLs and fractional synthesis fPLLs, resulting in a greater total number of PLLs available than the previous generation

### 1.3. FPGA and SoC Features Summary

**Table 2. Intel Stratix 10 FPGA and SoC Common Device Features**

Feature	Description
Technology	<ul style="list-style-type: none"> <li>• 14-nm Intel Tri-Gate (FinFET) process technology</li> <li>• SmartVID controlled core voltage, standard power devices</li> <li>• 0.85-V fixed core voltage, low static power devices available</li> </ul>
Low power serial transceivers	<ul style="list-style-type: none"> <li>• Up to 96 total transceivers available</li> <li>• Continuous operating range of 1 Gbps to 28.3 Gbps for Intel Stratix 10 GX/SX devices</li> <li>• Backplane support up to 28.3 Gbps for Intel Stratix 10 GX/SX devices</li> <li>• Extended range down to 125 Mbps with oversampling</li> <li>• ATX transmit PLLs with user-configurable fractional synthesis capability</li> <li>• XFP, SFP+, QSFP/QSFP28, CFP/CFP2/CFP4 optical module support</li> <li>• Adaptive linear and decision feedback equalization</li> <li>• Transmit pre-emphasis and de-emphasis</li> <li>• Dynamic partial reconfiguration of individual transceiver channels</li> <li>• On-chip instrumentation (Eye Viewer non-intrusive data eye monitoring)</li> </ul>
General purpose I/Os	<ul style="list-style-type: none"> <li>• Up to 1640 total GPIO available</li> <li>• 1.6 Gbps LVDS—every pair can be configured as an input or output</li> <li>• 1333 MHz/2666 Mbps DDR4 external memory interface</li> <li>• 1067 MHz/2133 Mbps DDR3 external memory interface</li> <li>• 1.2 V to 3.0 V single-ended LVCMOS/LVTTL interfacing</li> <li>• On-chip termination (OCT)</li> </ul>
Embedded hard IP	<ul style="list-style-type: none"> <li>• PCIe Gen1/Gen2/Gen3 complete protocol stack, x1/x2/x4/x8/x16 end point and root port</li> <li>• DDR4/DDR3/LPDDR3 hard memory controller (RLDRAM3/QDR II+/QDR IV using soft memory controller)</li> <li>• Multiple hard IP instantiations in each device</li> <li>• Single Root I/O Virtualization (SR-IOV)</li> </ul>
Transceiver hard IP	<ul style="list-style-type: none"> <li>• 10GBASE-KR/40GBASE-KR4 Forward Error Correction (FEC)</li> <li>• 10G Ethernet PCS</li> <li>• PCI Express PIPE interface</li> <li>• Interlaken PCS</li> <li>• Gigabit Ethernet PCS</li> <li>• Deterministic latency support for Common Public Radio Interface (CPRI) PCS</li> <li>• Fast lock-time support for Gigabit Passive Optical Networking (GPON) PCS</li> <li>• 8B/10B, 64B/66B, 64B/67B encoders and decoders</li> <li>• Custom mode support for proprietary protocols</li> </ul>
<i>continued...</i>	

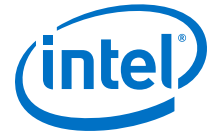

Feature	Description
Power management	<ul style="list-style-type: none"> <li>• SmartVID controlled core voltage, standard power devices</li> <li>• 0.85-V fixed core voltage, low static power devices available</li> <li>• Intel Quartus® Prime Pro Edition integrated power analysis</li> </ul>
High performance monolithic core fabric	<ul style="list-style-type: none"> <li>• HyperFlex core architecture with Hyper-Registers throughout the interconnect routing and at the inputs of all functional blocks</li> <li>• Monolithic fabric minimizes compile times and increases logic utilization</li> <li>• Enhanced adaptive logic module (ALM)</li> <li>• Improved multi-track routing architecture reduces congestion and improves compile times</li> <li>• Hierarchical core clocking architecture with programmable clock tree synthesis</li> <li>• Fine-grained partial reconfiguration</li> </ul>
Internal memory blocks	<ul style="list-style-type: none"> <li>• M20K—20-Kbit with hard ECC support</li> <li>• MLAB—640-bit distributed LUTRAM</li> </ul>
Variable precision DSP blocks	<ul style="list-style-type: none"> <li>• IEEE 754-compliant hard single-precision floating point capability</li> <li>• Supports signal processing with precision ranging from 18x19 up to 54x54</li> <li>• Native 27x27 and 18x19 multiply modes</li> <li>• 64-bit accumulator and cascade for systolic FIRs</li> <li>• Internal coefficient memory banks</li> <li>• Pre-adder/subtractor improves efficiency</li> <li>• Additional pipeline register increases performance and reduces power</li> </ul>
Phase locked loops (PLL)	<ul style="list-style-type: none"> <li>• Fractional synthesis PLLs (fPLL) support both fractional and integer modes</li> <li>• Fractional mode with third-order delta-sigma modulation</li> <li>• Precision frequency synthesis</li> <li>• Integer PLLs adjacent to general purpose I/Os, support external memory, and LVDS interfaces, clock delay compensation, zero delay buffering</li> </ul>
Core clock networks	<ul style="list-style-type: none"> <li>• 1 GHz fabric clocking</li> <li>• 667 MHz external memory interface clocking, supports 2666 Mbps DDR4 interface</li> <li>• 800 MHz LVDS interface clocking, supports 1600 Mbps LVDS interface</li> <li>• Programmable clock tree synthesis, backwards compatible with global, regional and peripheral clock networks</li> <li>• Clocks only synthesized where needed, to minimize dynamic power</li> </ul>
<b>continued...</b>	



Feature	Description
Configuration	<ul style="list-style-type: none"> <li>Dedicated Secure Device Manager</li> <li>Software programmable device configuration</li> <li>Serial and parallel flash interface</li> <li>Configuration via protocol (CvP) using PCI Express Gen1/Gen2/Gen3</li> <li>Fine-grained partial reconfiguration of core fabric</li> <li>Dynamic reconfiguration of transceivers and PLLs</li> <li>Comprehensive set of security features including AES-256, SHA-256/384, and ECDSA-256/384 accelerators, and multi-factor authentication</li> <li>Physically Unclonable Function (PUF) service</li> </ul>
Packaging	<ul style="list-style-type: none"> <li>Intel Embedded Multi-die Interconnect Bridge (EMIB) packaging technology</li> <li>Multiple devices with identical package footprints allows seamless migration across different device densities</li> <li>1.0 mm ball-pitch FBGA packaging</li> <li>Lead and lead-free package options</li> </ul>
Software and tools	<ul style="list-style-type: none"> <li>Intel Quartus Prime Pro Edition design suite with new compiler and Hyper-Aware design flow</li> <li>Fast Forward compiler to allow HyperFlex architecture performance exploration</li> <li>Transceiver toolkit</li> <li>Platform designer integration tool</li> <li>DSP Builder advanced blockset</li> <li>OpenCL™ support</li> <li>SoC Embedded Design Suite (EDS)</li> </ul>

**Table 3. Intel Stratix 10 SoC Specific Device Features**

SoC Subsystem	Feature	Description
<b>Hard Processor System</b>	Multi-processor unit (MPU) core	<ul style="list-style-type: none"> <li>Quad-core ARM Cortex-A53 MPCore processor with ARM CoreSight debug and trace technology</li> <li>Scalar floating-point unit supporting single and double precision</li> <li>ARM NEON media processing engine for each processor</li> </ul>
	System Controllers	<ul style="list-style-type: none"> <li>System Memory Management Unit (SMMU)</li> <li>Cache Coherency Unit (CCU)</li> </ul>
	Layer 1 Cache	<ul style="list-style-type: none"> <li>32 KB L1 instruction cache with parity</li> <li>32 KB L1 data cache with ECC</li> </ul>
	Layer 2 Cache	<ul style="list-style-type: none"> <li>1 MB Shared L2 Cache with ECC</li> </ul>
	On-Chip Memory	<ul style="list-style-type: none"> <li>256 KB On-Chip RAM</li> </ul>
	Direct memory access (DMA) controller	<ul style="list-style-type: none"> <li>8-Channel DMA</li> </ul>
	Ethernet media access controller (EMAC)	<ul style="list-style-type: none"> <li>Three 10/100/1000 EMAC with integrated DMA</li> </ul>
	USB On-The-Go controller (OTG)	<ul style="list-style-type: none"> <li>2 USB OTG with integrated DMA</li> </ul>
	UART controller	<ul style="list-style-type: none"> <li>2 UART 16550 compatible</li> </ul>
	Serial Peripheral Interface (SPI) controller	<ul style="list-style-type: none"> <li>4 SPI</li> </ul>
	I <sup>2</sup> C controller	<ul style="list-style-type: none"> <li>5 I<sup>2</sup>C controllers</li> </ul>
	SD/SDIO/MMC controller	<ul style="list-style-type: none"> <li>1 eMMC version 4.5 with DMA and CE-ATA support</li> <li>SD, including eSD, version 3.0</li> <li>SDIO, including eSDIO, version 3.0</li> <li>CE-ATA - version 1.1</li> </ul>

*continued...*



SoC Subsystem	Feature	Description
	NAND flash controller	<ul style="list-style-type: none"> <li>1 ONFI 1.0, 8- and 16-bit support</li> </ul>
	General-purpose I/O (GPIO)	<ul style="list-style-type: none"> <li>Maximum of 48 software programmable GPIO</li> </ul>
	Timers	<ul style="list-style-type: none"> <li>4 general-purpose timers</li> <li>4 watchdog timers</li> </ul>
<b>Secure Device Manager</b>	Security	<ul style="list-style-type: none"> <li>Secure boot</li> <li>Advanced Encryption Standard (AES) and authentication (SHA/ECDSA)</li> </ul>
<b>External Memory Interface</b>	External Memory Interface	<ul style="list-style-type: none"> <li>Hard Memory Controller with DDR4 and DDR3, and LPDDR3</li> </ul>

## 1.4. Intel Stratix 10 Block Diagram

Figure 2. Intel Stratix 10 FPGA and SoC Architecture Block Diagram

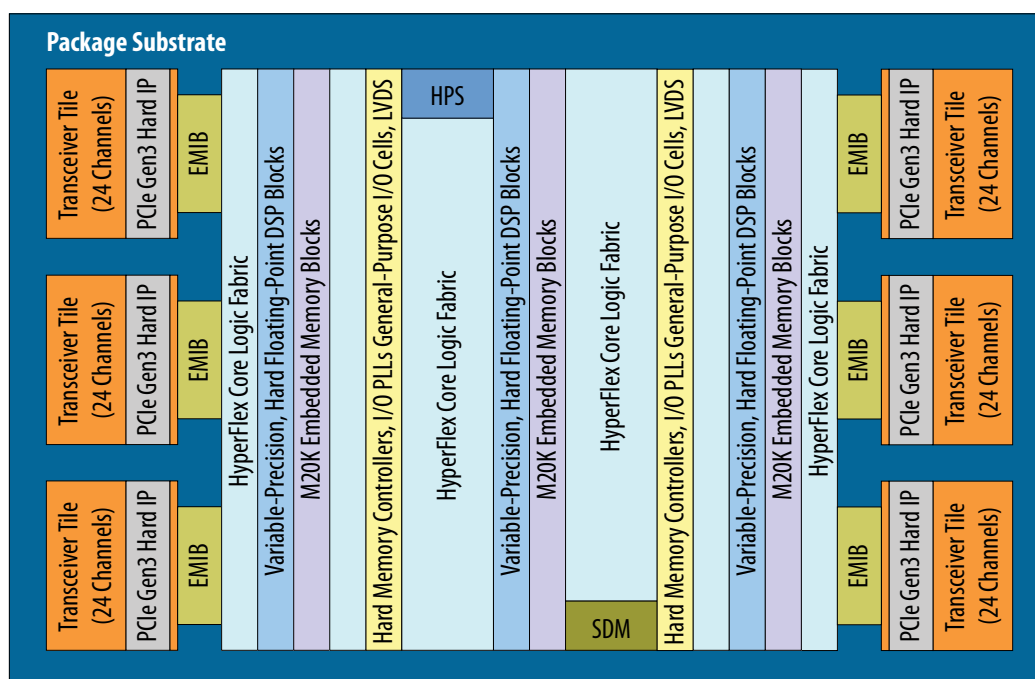

HPS: Quad ARM Cortex-A53 Hard Processor System  
SDM: Secure Device Manager  
EMIB: Embedded Multi-Die Interconnect Bridge

## 1.5. Intel Stratix 10 FPGA and SoC Family Plan

(1) The number of 27x27 multipliers is one-half the number of 18x19 multipliers.

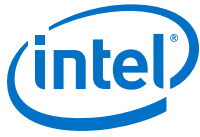

**Table 4. Intel Stratix 10 GX/SX FPGA and SoC Family Plan—FPGA Core (part 1)**

Intel Stratix 10 GX/SX Device Name	Logic Elements (KLE)	M20K Blocks	M20K Mbits	MLAB Counts	MLAB Mbits	18x19 Multipliers <sup>(1)</sup>
GX 400/ SX 400	378	1,537	30	3,204	2	1,296
GX 650/ SX 650	612	2,489	49	5,184	3	2,304
GX 850/ SX 850	841	3,477	68	7,124	4	4,032
GX 1100/ SX 1100	1,092	4,401	86	9,540	6	5,040
GX 1650/ SX 1650	1,624	5,851	114	13,764	8	6,290
GX 2100/ SX 2100	2,005	6,501	127	17,316	11	7,488
GX 2500/ SX 2500	2,422	9,963	195	20,529	13	10,022
GX 2800/ SX 2800	2,753	11,721	229	23,796	15	11,520
GX 4500/ SX 4500	4,463	7,033	137	37,821	23	3,960
GX 5500/ SX 5500	5,510	7,033	137	47,700	29	3,960

**Table 5. Intel Stratix 10 GX/SX FPGA and SoC Family Plan—Interconnects, PLLs and Hard IP (part 2)**

Intel Stratix 10 GX/SX Device Name	Interconnects		PLLs		Hard IP
	Maximum GPIOs	Maximum XCVR	fPLLs	I/O PLLs	PCIe Hard IP Blocks
GX 400/ SX 400	392	24	8	8	1
GX 650/ SX 650	400	48	16	8	2
GX 850/ SX 850	736	48	16	15	2
GX 1100/ SX 1100	736	48	16	15	2
GX 1650/ SX 1650	704	96	32	14	4
GX 2100/ SX 2100	704	96	32	14	4
GX 2500/ SX 2500	1160	96	32	24	4

*continued...*

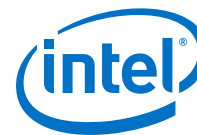

Intel Stratix 10 GX/SX Device Name	Interconnects		PLLs		Hard IP
	Maximum GPIOs	Maximum XCVR	fPLLs	I/O PLLs	PCIe Hard IP Blocks
GX 2800/ SX 2800	1160	96	32	24	4
GX 4500/ SX 4500	1640	24	8	34	1
GX 5500/ SX 5500	1640	24	8	34	1

**Table 6. Intel Stratix 10 GX/SX FPGA and SoC Family Package Plan, part 1**

Cell legend: General Purpose I/Os, High-Voltage I/Os, LVDS Pairs, Transceivers <sup>(2)</sup> <sup>(3)</sup> <sup>(4)</sup> <sup>(5)</sup> <sup>(6)</sup> <sup>(7)</sup>

Intel Stratix 10 GX/SX Device Name	F1152 HF35 (35x35 mm <sup>2</sup> )	F1760 NF43 (42.5x42.5 mm <sup>2</sup> )	F1760 NF43 (42.5x42.5 mm <sup>2</sup> )
GX 400/ SX 400	392, 8, 192, 24		
GX 650/ SX 650	392, 8, 192, 24	400, 16, 192, 48	
GX 850/ SX 850			688, 16, 336, 48
GX 1100/ SX 1100			688, 16, 336, 48
GX 1650/ SX 1650			688, 16, 336, 48
GX 2100/ SX 2100			688, 16, 336, 48
GX 2500/ SX 2500			688, 16, 336, 48
GX 2800/ SX 2800			688, 16, 336, 48

*continued...*

- (2) All packages are ball grid arrays with 1.0 mm pitch.
- (3) High-Voltage I/O pins are used for 3 V and 2.5 V interfacing.
- (4) Each LVDS pair can be configured as either a differential input or a differential output.
- (5) High-Voltage I/O pins and LVDS pairs are included in the General Purpose I/O count. Transceivers are counted separately.
- (6) Each package column offers pin migration (common circuit board footprint) for all devices in the column.
- (7) Intel Stratix 10 GX devices are pin migratable with Intel Stratix 10 SX devices in the same package.

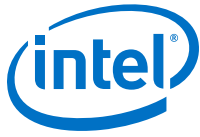

Intel Stratix 10 GX/SX Device Name	F1152 HF35 (35x35 mm <sup>2</sup> )	F1760 NF43 (42.5x42.5 mm <sup>2</sup> )	F1760 NF43 (42.5x42.5 mm <sup>2</sup> )
SX 2800			
GX 4500/ SX 4500			
GX 5500/ SX 5500			

**Table 7. Intel Stratix 10 GX/SX FPGA and SoC Family Package Plan, part 2**

Cell legend: General Purpose I/Os, High-Voltage I/Os, LVDS Pairs, Transceivers <sup>(2)</sup> <sup>(3)</sup> <sup>(4)</sup> <sup>(5)</sup> <sup>(6)</sup> <sup>(7)</sup>

Intel Stratix 10 GX/SX Device Name	F2112 NF48 (47.5x47.5 mm <sup>2</sup> )	F2397 UF50 (50x50 mm <sup>2</sup> )	F2912 HF55 (55x55 mm <sup>2</sup> )
GX 400/ SX 400			
GX 650/ SX 650			
GX 850/ SX 850	736, 16, 360, 48		
GX 1100/ SX 1100	736, 16, 360, 48		
GX 1650/ SX 1650		704, 32, 336, 96	
GX 2100/ SX 2100		704, 32, 336, 96	
GX 2500/ SX 2500		704, 32, 336, 96	1160, 8, 576, 24
GX 2800/ SX 2800		704, 32, 336, 96	1160, 8, 576, 24
GX 4500/ SX 4500			1640, 8, 816, 24
GX 5500/ SX 5500			1640, 8, 816, 24



## 1.6. HyperFlex Core Architecture

Intel Stratix 10 FPGAs and SoCs are based on a monolithic core fabric featuring the new HyperFlex core architecture. The HyperFlex core architecture delivers 2X the clock frequency performance and up to 70% lower power compared to previous generation high-end FPGAs. Along with this performance breakthrough, the HyperFlex core architecture delivers a number of advantages including:

- **Higher Throughput**—Leverages 2X core clock frequency performance to obtain throughput breakthroughs
- **Improved Power Efficiency**—Uses reduced IP size, enabled by HyperFlex, to consolidate designs which previously spanned multiple devices into a single device, thereby reducing power by up to 70% versus previous generation devices
- **Greater Design Functionality**—Uses faster clock frequency to reduce bus widths and reduce IP size, freeing up additional FPGA resources to add greater functionality
- **Increased Designer Productivity**—Boosts performance with less routing congestion and fewer design iterations using Hyper-Aware design tools, obtaining greater timing margin for more rapid timing closure

In addition to the traditional user registers found in the Adaptive Logic Modules (ALM), the HyperFlex core architecture introduces additional bypassable registers everywhere throughout the fabric of the FPGA. These additional registers, called Hyper-Registers are available on every interconnect routing segment and at the inputs of all functional blocks.

**Figure 3. Bypassable Hyper-Register**

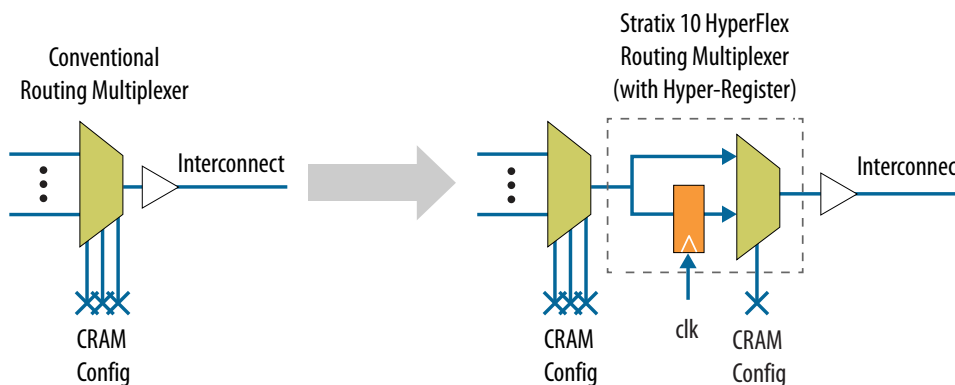

The Hyper-Registers enable the following key design techniques to achieve the 2X core performance increases:

- Fine grain Hyper-Retiming to eliminate critical paths
- Zero latency Hyper-Pipelining to eliminate routing delays
- Flexible Hyper-Optimization for best-in-class performance

By implementing these techniques in your design, the Hyper-Aware design tools automatically make use of the Hyper-Registers to achieve maximum core clock frequency.



Figure 4. HyperFlex Core Architecture

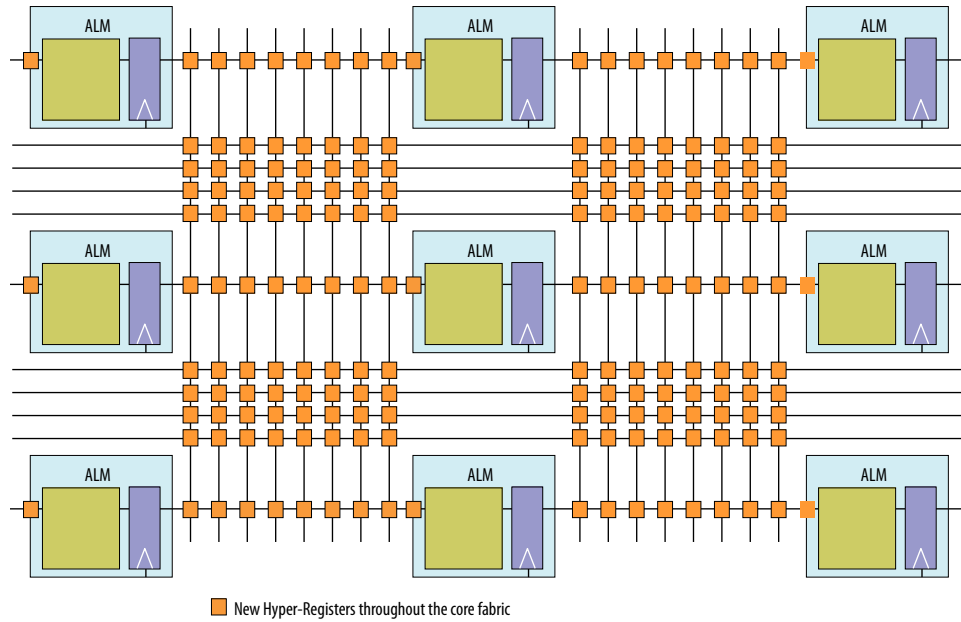

### 1.7. Heterogeneous 3D SiP Transceiver Tiles

Intel Stratix 10 FPGAs and SoCs feature power efficient, high bandwidth, low latency transceivers. The transceivers are implemented on heterogeneous 3D System-in-Package (SiP) transceiver tiles, each containing 24 full-duplex transceiver channels. In addition to providing a high-performance transceiver solution to meet current connectivity needs, this allows for future flexibility and scalability as data rates, modulation schemes, and protocol IPs evolve.

Figure 5. Monolithic Core Fabric and Heterogeneous 3D SiP Transceiver Tiles

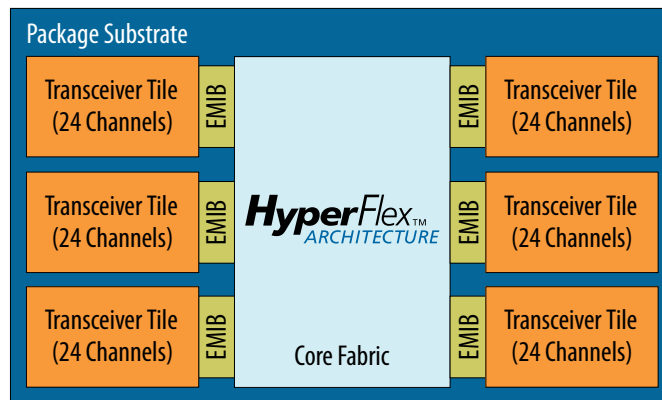

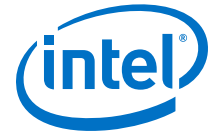

Each transceiver tile contains:

- 24 full-duplex transceiver channels (PMA and PCS)
- Reference clock distribution network
- Transmit PLLs
- High-speed clocking and bonding networks
- One instance of PCI Express hard IP

Figure 6. Heterogeneous 3D SiP Transceiver Tile Architecture

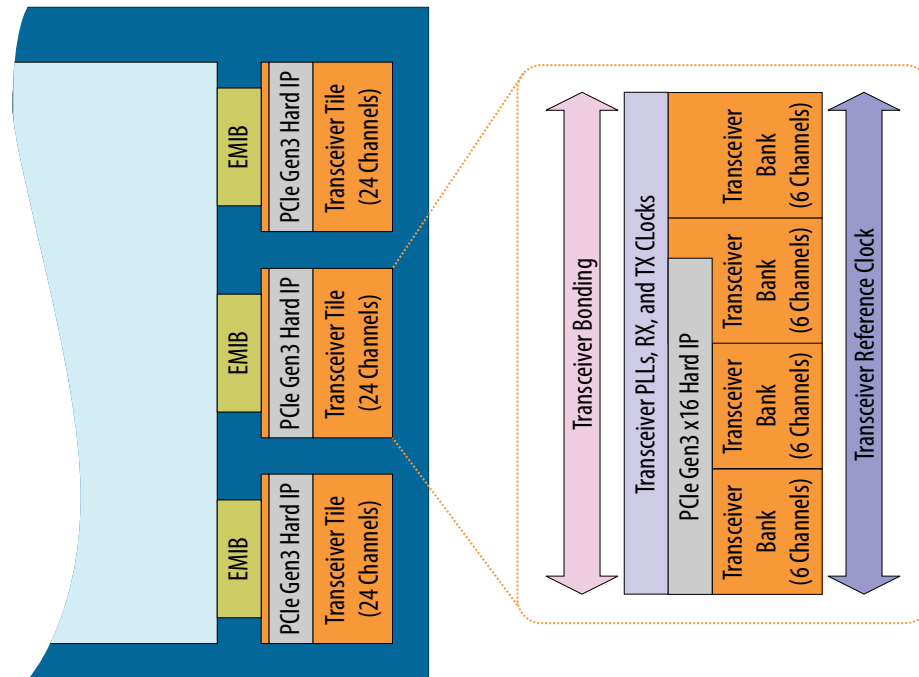

## 1.8. Intel Stratix 10 Transceivers

Intel Stratix 10 devices offer up to 96 total full-duplex transceiver channels. These channels provide continuous data rates from 1 Gbps to 28.3 Gbps for chip-to-chip, chip-to-module, and backplane applications. In each device, two thirds of the transceivers can be configured up to the maximum data rate of 28.3 Gbps to drive 100G interfaces and C form-factor pluggable CFP2/CFP4 optical modules. For longer-reach backplane driving applications, advanced adaptive equalization circuits are used to equalize over 30 dB of system loss.

All transceiver channels feature a dedicated Physical Medium Attachment (PMA) and a hardened Physical Coding Sublayer (PCS).

- The PMA provides primary interfacing capabilities to physical channels.
- The PCS typically handles encoding/decoding, word alignment, and other pre-processing functions before transferring data to the FPGA core fabric.

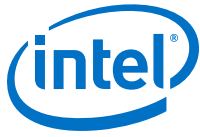

Within each transceiver tile, the transceivers are arranged in four banks of six PMA-PCS groups. A wide variety of bonded and non-bonded data rate configurations are possible within each bank, and within each tile, using a highly configurable clock distribution network.

### 1.8.1. PMA Features

PMA channels are comprised of transmitter (TX), receiver (RX), and high speed clocking resources.

Intel Stratix 10 device features provide exceptional signal integrity at data rates up to 28.3 Gbps. Clocking options include ultra-low jitter LC tank-based (ATX) PLLs with optional fractional synthesis capability, channel PLLs operating as clock multiplier units (CMUs), and fractional synthesis PLLs (fPLLs).

- **ATX PLL**—can be configured in integer mode, or optionally, in a new fractional synthesis mode. Each ATX PLL spans the full frequency range of the supported data rate range providing a stable, flexible clock source with the lowest jitter.
- **CMU PLL**—when not being used as a transceiver, select PMA channels can be configured as channel PLLs operating as CMUs to provide an additional master clock source within the transceiver bank.
- **fPLL**—In addition, dedicated fPLLs are available with precision frequency synthesis capabilities. fPLLs can be used to synthesize multiple clock frequencies from a single reference clock source and replace multiple reference oscillators for multi-protocol and multi-rate applications.

On the receiver side, each PMA has an independent channel PLL that allows analog tracking for clock-data recovery. Each PMA also has advanced equalization circuits that compensate for transmission losses across a wide frequency spectrum.

- **Variable Gain Amplifier (VGA)**—to optimize the receiver's dynamic range
- **Continuous Time Linear Equalizer (CTLE)**—to compensate for channel losses with lowest power dissipation
- **Decision Feedback Equalizer (DFE)**—to provide additional equalization capability on backplanes even in the presence of crosstalk and reflections
- **On-Die Instrumentation (ODI)**—to provide on-chip eye monitoring capabilities (Eye Viewer). This capability helps to optimize link equalization parameters during board bring-up and supports in-system link diagnostics and equalization margin testing

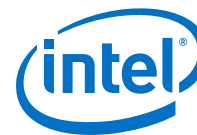
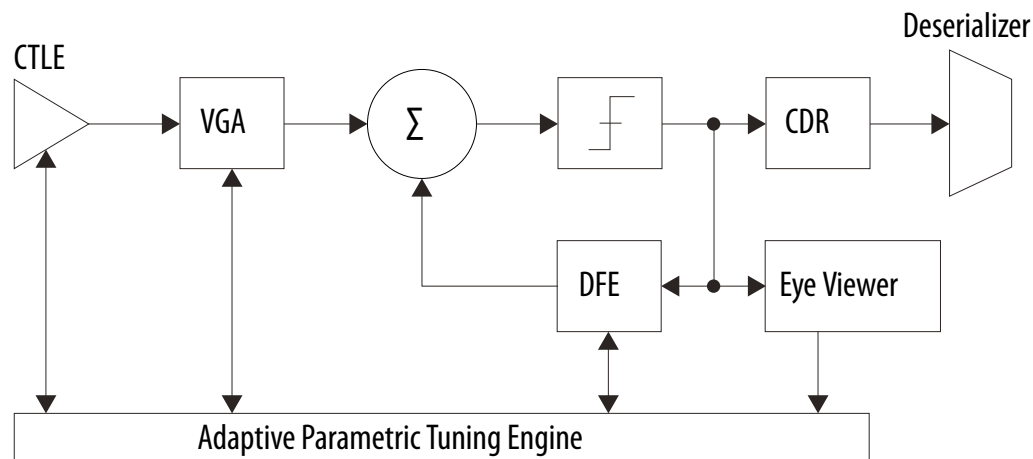

Figure 7. Intel Stratix 10 Receiver Block Features



All link equalization parameters feature automatic adaptation using the new Advanced Digital Adaptive Parametric Tuning (ADAPT) circuit. This circuit is used to dynamically set DFE tap weights, adjust CTLE parameters, and optimize VGA gain and threshold voltage. Finally, optimal and consistent signal integrity is ensured by using the new hardened Precision Signal Integrity Calibration Engine (PreSICE) to automatically calibrate all transceiver circuit blocks on power-up. This gives the most link margin and ensures robust, reliable, and error-free operation.

Table 8. Transceiver PMA Features

Feature	Capability
Chip-to-Chip Data Rates	1 Gbps <sup>(8)</sup> to 28.3 Gbps (Intel Stratix 10 GX/SX devices)
Backplane Support	Drive backplanes at data rates up to 28.3 Gbps, including 10GBASE-KR compliance
Optical Module Support	SFP+/SFP, XFP, CXP, QSFP/QSFP28, QSFPDD, CFP/CFP2/CFP4
Cable Driving Support	SFP+ Direct Attach, PCI Express over cable, eSATA
Transmit Pre-Emphasis	5-tap transmit pre-emphasis and de-emphasis to compensate for system channel loss
Continuous Time Linear Equalizer (CTLE)	Dual mode, high-gain, and high-data rate, linear receive equalization to compensate for system channel loss
Decision Feedback Equalizer (DFE)	15 fixed tap DFE to equalize backplane channel loss in the presence of crosstalk and noisy environments
Advanced Digital Adaptive Parametric Tuning (ADAPT)	Fully digital adaptation engine to automatically adjust all link equalization parameters—including CTLE, DFE, and VGA blocks—that provide optimal link margin without intervention from user logic
Precision Signal Integrity Calibration Engine (PreSICE)	Hardened calibration controller to quickly calibrate all transceiver control parameters on power-up, which provides the optimal signal integrity and jitter performance
ATX Transmit PLLs	Low jitter ATX (inductor-capacitor) transmit PLLs with continuous tuning range to cover a wide range of standard and proprietary protocols, with optional fractional frequency synthesis capability
Fractional PLLs	On-chip fractional frequency synthesizers to replace on-board crystal oscillators and reduce system cost

*continued...*

<sup>(8)</sup> Stratix 10 transceivers can support data rates below 1 Gbps with over sampling.

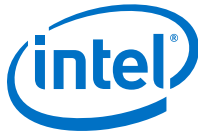

Feature	Capability
Digitally Assisted Analog CDR	Superior jitter tolerance with fast lock time
On-Die Instrumentation—Eye Viewer and Jitter Margin Tool	Simplify board bring-up, debug, and diagnostics with non-intrusive, high-resolution eye monitoring (Eye Viewer). Also inject jitter from transmitter to test link margin in system.
Dynamic Reconfiguration	Allows for independent control of each transceiver channel Avalon memory-mapped interface for the most transceiver flexibility.
Multiple PCS-PMA and PCS-Core to FPGA fabric interface widths	8-, 10-, 16-, 20-, 32-, 40-, or 64-bit interface widths for flexibility of deserialization width, encoding, and reduced latency

## 1.8.2. PCS Features

Intel Stratix 10 PMA channels interface with core logic through configurable and bypassable PCS interface layers.

The PCS contains multiple gearbox implementations to decouple the PMA and PCS interface widths. This feature provides the flexibility to implement a wide range of applications with 8, 10, 16, 20, 32, 40, or 64-bit interface width between each transceiver and the core logic.

The PCS also contains hard IP to support a variety of standard and proprietary protocols across a wide range of data rates and encoding schemes. The Standard PCS mode provides support for 8B/10B encoded applications up to 12.5 Gbps. The Enhanced PCS mode supports 64B/66B and 64B/67B encoded applications up to 17.4 Gbps. The enhanced PCS mode also includes an integrated 10GBASE-KR/40GBASE-KR4 Forward Error Correction (FEC) circuit. For highly customized implementations, a PCS Direct mode provides an interface up to 64 bits wide to allow for custom encoding and support for data rates up to 28.3 Gbps.

For more information about the PCS-Core interface or the double rate transfer mode, refer to the *Intel Stratix 10 L- and H-Tile Transceiver PHY User Guide*, and the *Intel Stratix 10 E-Tile Transceiver PHY User Guide*.

**Table 9. Transceiver PCS Features**

PCS Protocol Support	Data Rate (Gbps)	Transmitter Data Path	Receiver Data Path
Standard PCS	1 to 12.5	Phase compensation FIFO, byte serializer, 8B/10B encoder, bit-slipper, channel bonding	Rate match FIFO, word-aligner, 8B/10B decoder, byte deserializer, byte ordering
PCI Express Gen1/Gen2 x1, x2, x4, x8, x16	2.5 and 5.0	Same as Standard PCS plus PIPE 2.0 interface to core	Same as Standard PCS plus PIPE 2.0 interface to core
PCI Express Gen3 x1, x2, x4, x8, x16	8.0	Phase compensation FIFO, byte serializer, encoder, scrambler, bit-slipper, gear box, channel bonding, and PIPE 3.0 interface to core, auto speed negotiation	Rate match FIFO (0-600 ppm mode), word-aligner, decoder, descrambler, phase compensation FIFO, block sync, byte deserializer, byte ordering, PIPE 3.0 interface to core, auto speed negotiation
CPRI	0.6144 to 9.8	Same as Standard PCS plus deterministic latency serialization	Same as Standard PCS plus deterministic latency deserialization

*continued...*

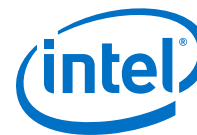

PCS Protocol Support	Data Rate (Gbps)	Transmitter Data Path	Receiver Data Path
Enhanced PCS	2.5 to 17.4	FIFO, channel bonding, bit-slipper, and gear box	FIFO, block sync, bit-slipper, and gear box
10GBASE-R	10.3125	FIFO, 64B/66B encoder, scrambler, FEC, and gear box	FIFO, 64B/66B decoder, descrambler, block sync, FEC, and gear box
Interlaken	4.9 to 17.4	FIFO, channel bonding, frame generator, CRC-32 generator, scrambler, disparity generator, bit-slipper, and gear box	FIFO, CRC-32 checker, frame sync, descrambler, disparity checker, block sync, and gear box
SFI-S/SFI-5.2	11.3	FIFO, channel bonding, bit-slipper, and gear box	FIFO, bit-slipper, and gear box
IEEE 1588	1.25 to 10.3125	FIFO (fixed latency), 64B/66B encoder, scrambler, and gear box	FIFO (fixed latency), 64B/66B decoder, descrambler, block sync, and gear box
SDI	up to 12.5	FIFO and gear box	FIFO, bit-slipper, and gear box
GigE	1.25	Same as Standard PCS plus GigE state machine	Same as Standard PCS plus GigE state machine
PCS Direct	up to 28.3	Custom	Custom

### Related Information

[Intel Stratix 10 L- and H-Tile Transceiver PHY User Guide](#)

## 1.9. PCI Express Gen1/Gen2/Gen3 Hard IP

Intel Stratix 10 devices contain embedded PCI Express hard IP designed for performance, ease-of-use, increased functionality, and designer productivity.

The PCI Express hard IP consists of the PHY, Data Link, and Transaction layers. It also supports PCI Express Gen1/Gen2/Gen3 end point and root port, in x1/x2/x4/x8/x16 lane configurations. The PCI Express hard IP is capable of operating independently from the core logic (autonomous mode). This feature allows the PCI Express link to power up and complete link training in less than 100 ms, while the rest of the device is still in the process of being configured. The hard IP also provides added functionality, which makes it easier to support emerging features such as Single Root I/O Virtualization (SR-IOV) and optional protocol extensions.

The PCI Express hard IP has improved end-to-end data path protection using Error Checking and Correction (ECC). In addition, the hard IP supports configuration of the device via protocol (CvP) across the PCI Express bus at Gen1/Gen2/Gen3 rates.

## 1.10. Interlaken PCS Hard IP

Intel Stratix 10 devices have integrated Interlaken PCS hard IP supporting rates up to 17.4 Gbps per lane.

The Interlaken PCS hard IP is based on the proven functionality of the PCS developed for Intel's previous generation FPGAs, which has demonstrated interoperability with Interlaken ASSP vendors and third-party IP suppliers. The Interlaken PCS hard IP is present in every transceiver channel in Intel Stratix 10 devices.

### 1.11. 10G Ethernet Hard IP

Intel Stratix 10 devices include IEEE 802.3 10-Gbps Ethernet (10GbE) compliant 10GBASE-R PCS and PMA hard IP. The scalable 10GbE hard IP supports multiple independent 10GbE ports while using a single PLL for all the 10GBASE-R PCS instantiations, which saves on core logic resources and clock networks.

The integrated serial transceivers simplify multi-port 10GbE systems compared to 10 GbE Attachment Unit Interface (XAUI) interfaces that require an external XAUI-to-10G PHY. Furthermore, the integrated transceivers incorporate signal conditioning circuits, which enable direct connection to standard 10G XFP and SFP+ pluggable optical modules. The transceivers also support backplane Ethernet applications and include a hard 10GBASE-KR/40GBASE-KR4 Forward Error Correction (FEC) circuit that can be used for both 10G and 40G applications. The integrated 10G Ethernet hard IP and 10G transceivers save external PHY cost, board space and system power. The 10G Ethernet PCS hard IP and 10GBASE-KR FEC are present in every transceiver channel.

### 1.12. External Memory and General Purpose I/O

Intel Stratix 10 devices offer substantial external memory bandwidth, with up to ten 72-bit wide DDR4 memory interfaces running at up to 2666 Mbps.

This bandwidth is provided along with the ease of design, lower power, and resource efficiencies of hardened high-performance memory controllers. The external memory interfaces can be configured up to a maximum width of 144 bits when using either hard or soft memory controllers.

Figure 8. Hard Memory Controller

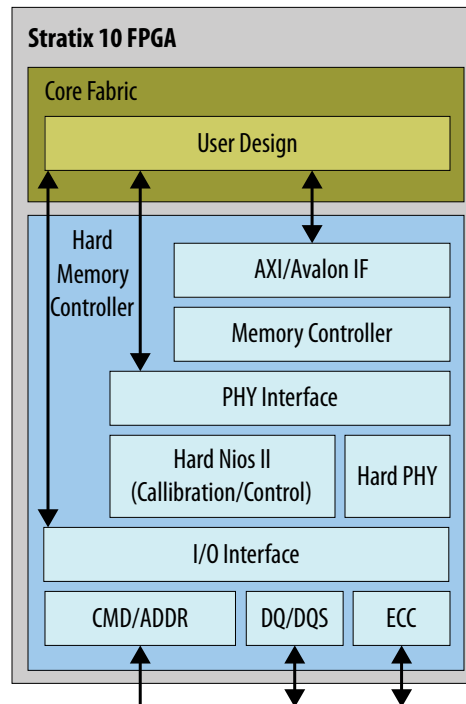

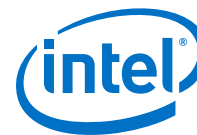

Each I/O bank contains 48 general purpose I/Os and a high-efficiency hard memory controller capable of supporting many different memory types, each with different performance capabilities. The hard memory controller is also capable of being bypassed and replaced by a soft controller implemented in the user logic. The I/Os each have a hardened double data rate (DDR) read/write path (PHY) capable of performing key memory interface functionality such as:

- Read/write leveling
- FIFO buffering to lower latency and improve margin
- Timing calibration
- On-chip termination

The timing calibration is aided by the inclusion of hard microcontrollers based on Intel's Nios® II technology, specifically tailored to control the calibration of multiple memory interfaces. This calibration allows the Intel Stratix 10 device to compensate for any changes in process, voltage, or temperature either within the Intel Stratix 10 device itself, or within the external memory device. The advanced calibration algorithms ensure maximum bandwidth and robust timing margin across all operating conditions.

**Table 10. External Memory Interface Performance**

The listed speeds are for the 1-rank case.

Interface	Controller Type	Performance
DDR4	Hard	2666 Mbps
DDR3	Hard	2133 Mbps
QDRII+	Soft	1,100 Mtps
QDRII+ Xtreme	Soft	1,266 Mtps
QDRIV	Soft	2,133 Mtps
RLDRAM III	Soft	2400 Mbps
RLDRAM II	Soft	533 Mbps

In addition to parallel memory interfaces, Intel Stratix 10 devices support serial memory technologies such as the Hybrid Memory Cube (HMC). The HMC is supported by the Intel Stratix 10 high-speed serial transceivers, which connect up to four HMC links, with each link running at data rates of 15 Gbps (HMC short reach specification).

Intel Stratix 10 devices also feature general purpose I/Os capable of supporting a wide range of single-ended and differential I/O interfaces. LVDS rates up to 1.6 Gbps are supported, with each pair of pins having both a differential driver and a differential input buffer. This enables configurable direction for each LVDS pair.

### 1.13. Adaptive Logic Module (ALM)

Intel Stratix 10 devices use a similar adaptive logic module (ALM) as the previous generation Arria 10 and Stratix V FPGAs, allowing for efficient implementation of logic functions and easy conversion of IP between the devices.

The ALM block diagram shown in the following figure has eight inputs with a fracturable look-up table (LUT), two dedicated embedded adders, and four dedicated registers.



Figure 9. Intel Stratix 10 FPGA and SoC ALM Block Diagram

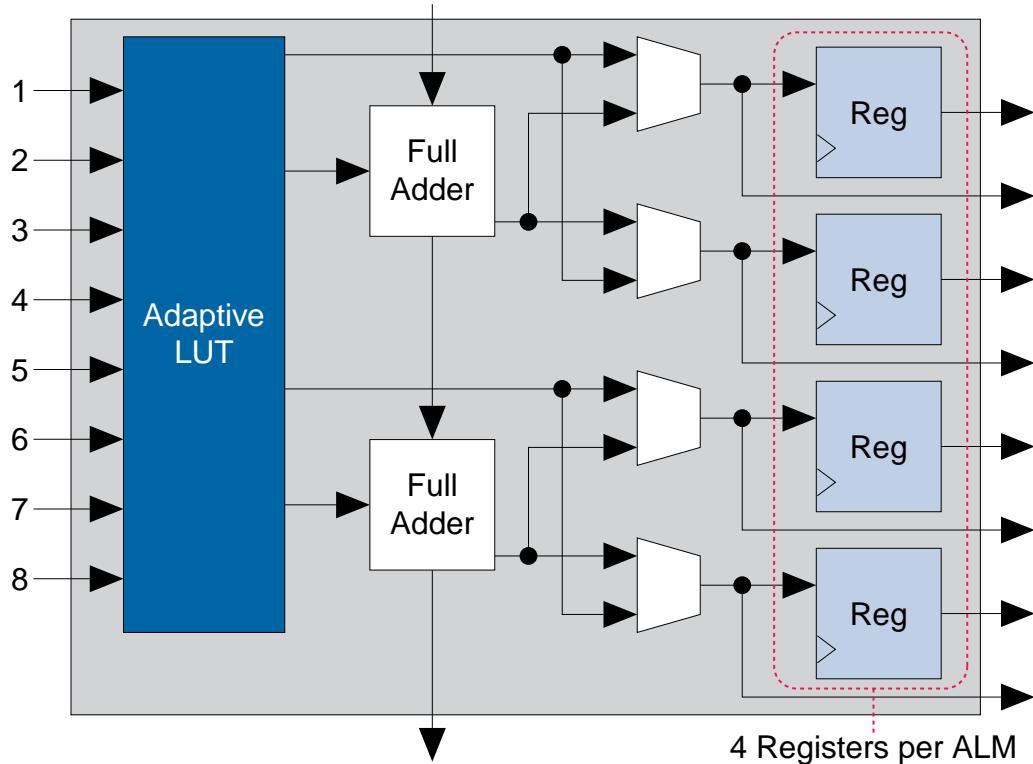

Key features and capabilities of the ALM include:

- High register count with 4 registers per 8-input fracturable LUT, operating in conjunction with the new HyperFlex architecture, enables Intel Stratix 10 devices to maximize core performance at very high core logic utilization
- Implements select 7-input logic functions, all 6-input logic functions, and two independent functions consisting of smaller LUT sizes (such as two independent 4-input LUTs) to optimize core logic utilization

The Intel Quartus Prime software leverages the ALM logic structure to deliver the highest performance, optimal logic utilization, and lowest compile times. The Intel Quartus Prime software simplifies design reuse as it automatically maps legacy designs into the Intel Stratix 10 ALM architecture.

### 1.14. Core Clocking

Core clocking in Intel Stratix 10 devices makes use of programmable clock tree synthesis.

This technique uses dedicated clock tree routing and switching circuits, and allows the Intel Quartus Prime software to create the exact clock trees required for your design. Clock tree synthesis minimizes clock tree insertion delay, reduces dynamic power dissipation in the clock tree and allows greater clocking flexibility in the core while still maintaining backwards compatibility with legacy global and regional clocking schemes.

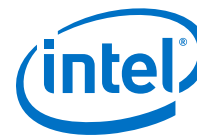

The core clock network in Intel Stratix 10 devices supports the new HyperFlex core architecture at clock rates up to 1 GHz. It also supports the hard memory controllers up to 2666 Mbps with a quarter rate transfer to the core. The core clock network is supported by dedicated clock input pins, fractional clock synthesis PLLs, and integer I/O PLLs.

### 1.15. Fractional Synthesis PLLs and I/O PLLs

Intel Stratix 10 devices have up to 32 fractional synthesis PLLs (fPLL) available for use with transceivers or in the core fabric.

The fPLLs are located in the 3D SiP transceiver H-tiles, eight per tile, adjacent to the transceiver channels. The fPLLs can be used to reduce both the number of oscillators required on the board and the number of clock pins required, by synthesizing multiple clock frequencies from a single reference clock source. In addition to synthesizing reference clock frequencies for the transceiver transmit PLLs, the fPLLs can also be used directly for transmit clocking. Each fPLL can be independently configured for conventional integer mode, or enhanced fractional synthesis mode with third-order delta-sigma modulation.

In addition to the fPLLs, Intel Stratix 10 devices contain up to 34 integer I/O PLLs (IOPLLs) available for general purpose use in the core fabric and for simplifying the design of external memory interfaces and high-speed LVDS interfaces. The IOPLLs are located in each bank of 48 general purpose I/O, 1 per I/O bank, adjacent to the hard memory controllers and LVDS SerDes in each I/O bank. This makes it easier to close timing because the IOPLLs are tightly coupled with the I/Os that need to use them. The IOPLLs can be used for general purpose applications in the core such as clock network delay compensation and zero-delay clock buffering.

### 1.16. Internal Embedded Memory

Intel Stratix 10 devices contain two types of embedded memory blocks: M20K (20-Kbit) and MLAB (640-bit).

The M20K and MLAB blocks are familiar block sizes carried over from previous Intel device families. The MLAB blocks are ideal for wide and shallow memories, while the M20K blocks are intended to support larger memory configurations and include hard ECC. Both M20K and MLAB embedded memory blocks can be configured as a single-port or dual-port RAM, FIFO, ROM, or shift register. These memory blocks are highly flexible and support a number of memory configurations as shown in [Table 11](#) on page 25.

**Table 11. Internal Embedded Memory Block Configurations**

MLAB (640 bits)	M20K (20 Kbits)
64 x 10 (supported through emulation) 32 x 20	2K x 10 (or x8) 1K x 20 (or x16) 512 x 40 (or x32)

### 1.17. Variable Precision DSP Block

The Intel Stratix 10 DSP blocks are based upon the Variable Precision DSP Architecture used in Intel's previous generation devices. They feature hard fixed point and IEEE-754 compliant floating point capability.