



Chipsmall Limited consists of a professional team with an average of over 10 year of expertise in the distribution of electronic components. Based in Hongkong, we have already established firm and mutual-benefit business relationships with customers from,Europe,America and south Asia,supplying obsolete and hard-to-find components to meet their specific needs.

With the principle of "Quality Parts,Customers Priority,Honest Operation,and Considerate Service",our business mainly focus on the distribution of electronic components. Line cards we deal with include Microchip,ALPS,ROHM,Xilinx,Pulse,ON,Everlight and Freescale. Main products comprise IC,Modules,Potentiometer,IC Socket,Relay,Connector.Our parts cover such applications as commercial,industrial, and automotives areas.

We are looking forward to setting up business relationship with you and hope to provide you with the best service and solution. Let us make a better world for our industry!



Contact us

Tel: +86-755-8981 8866 Fax: +86-755-8427 6832

Email & Skype: info@chipsmall.com Web: www.chipsmall.com

Address: A1208, Overseas Decoration Building, #122 Zhenhua RD., Futian, Shenzhen, China



Description

Single pole thermal circuit breaker with push-to-reset, tease-free, trip-free, snap action mechanism (R type TO CBE to EN 60934). Featuring auxiliary contacts (1 x N/C; 1 x N/O) as standard. Options include an additional unprotected circuit tap (-A3). Approved to CBE standard EN 60934 (IEC 60934).

Typical applications

Motors, transformers, solenoids, controls for oil and gas boilers.

Ordering information

Type No.

2-6400 threadneck panel mounting, with auxiliary contacts

Mounting

iG1 moulded threadneck 3/8-27UNS-2A with hexnut and plastic knurled nut (hardware bulk shipped for 5 pcs plus)

iG2 moulded threadneck M12x1 with hexnut and knurled nut (hardware bulk shipped for 5 pcs plus)

Terminal design - main circuit

L10 solder terminals

P10 blade terminals A6.3-0.8 mm (QC .250)

Shunt terminal (optional)

A3 shunt terminal same as main terminal (up to 7/5 A max. load; up to 16 A/10 A max. load)

Auxiliary contacts

Si N/O and N/C contacts, solder terminals

Current ratings

0.05...16 A

2-6400 - .. - P10 - .. - Si - 8 A ordering example

The exact part number required can be built up from the table of choices shown above. Ordering references for optional features should be omitted if not required.

Standard current ratings and typical internal resistance values

| Current rating (A) | Internal resistance (Ω) | Current rating (A) | Internal resistance (Ω) |
|--------------------|-------------------------|--------------------|-------------------------|
| 0.05 | 257 | 2 | 0.30 |
| 0.08 | 138 | 2.5 | 0.20 |
| 0.1 | 90 | 3 | 0.12 |
| 0.2 | 32.2 | 3,5 | 0.10 |
| 0.3 | 14.6 | 4 | 0.07 |
| 0.4 | 8.4 | 4.5 | 0.056 |
| 0.5 | 5.15 | 5 | 0.046 |
| 0.6 | 3.82 | 6 | 0.035 |
| 0.7 | 2.80 | 7 | 0.03 |
| 0.8 | 2.15 | 8 | < 0.02 |
| 1 | 1.42 | 10 | < 0.02 |
| 1.2 | 0.96 | 12 | < 0.02 |
| 1.5 | 0.51 | 15 | < 0.02 |
| 1.8 | 0.40 | 16 | < 0.02 |



2-6400-...

Technical data

For further details please see chapter: Technical Information

| | | |
|---|--|--|
| Voltage rating | AC 250 V; DC 28 V | |
| Current rating range | 0.05...16 A | |
| Auxiliary circuit | 1 A, AC 250 V/DC 28 V | |
| Typical life | 0.05...16 A 5,000 operations at 2 x I _N , inductive | |
| Ambient temperature | -20...+60 °C (-4...+140 °F) | |
| Insulation co-ordination (IEC 60664 and 60664A) | rated impulse withstand voltage 2.5 kV | pollution degree 2 |
| | reinforced insulation in operating area | |
| Dielectric strength (IEC 60664 and 60664A) | test voltage operating area main circuit to aux. circuit | AC 3,000 V |
| | aux. circuit 4-5 to 6-7 | AC 1,500 V AC 840 V |
| Insulation resistance | > 100 MΩ (DC 500 V) | |
| Interrupting capacity I _{cn} | 10 x I _N | |
| Interrupting capacity (UL 1077) | I _N 0.05...4.5 A 5...8 A 8.5...16 A | U _N AC 250 V 200 A AC 250 V 1,000 A AC 250 V 2,000 A |
| Degree of protection (IEC 60529/DIN 40050) | operating area IP40 terminal area IP00 | |
| Vibration | 10 g (57-500 Hz) ± 0.76 mm (10-57 Hz), to IEC 60068-2-6, test Fc, 10 frequency cycles/axis | |
| Shock | 40 g (11 ms) to IEC 60068-2-27, test Ea | |
| Corrosion | 96 hours at 5 % salt mist, to IEC 60068-2-11, test Ka | |
| Humidity | 240 hours at 95 % RH to IEC 60068-2-78, test Cab | |
| Mass | approx. 25 g | |

Approvals

| Authority | Standard | Rated voltage | Current ratings |
|-----------|--------------|---------------------|--------------------------------|
| VDE | IEC/EN 60934 | AC 250 V DC 28 V | 0.05 A...16 A 0.05 A...16 A |
| UL | UL 1077 | AC 250 V DC 28 V | 0.05 A...16 A 0.05 A...16 A |
| CSA | C22.2 No 235 | AC 250 V DC 28 V | 0.05 A...16 A 0.05 A...16 A |

Dimensions

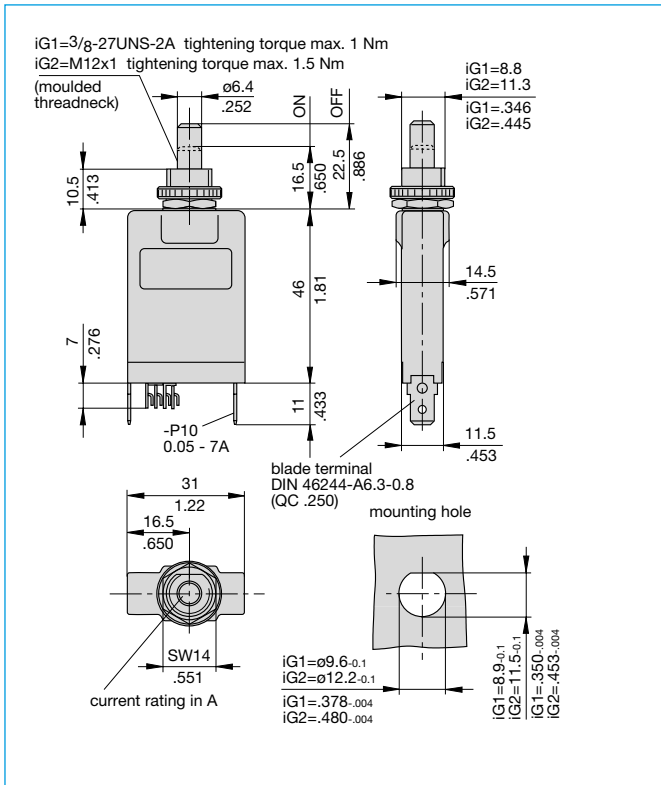

Internal connection diagrams

0.05...7 A

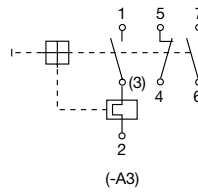

8...16 A

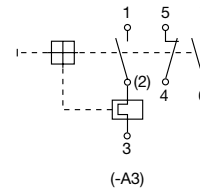

Installation drawing

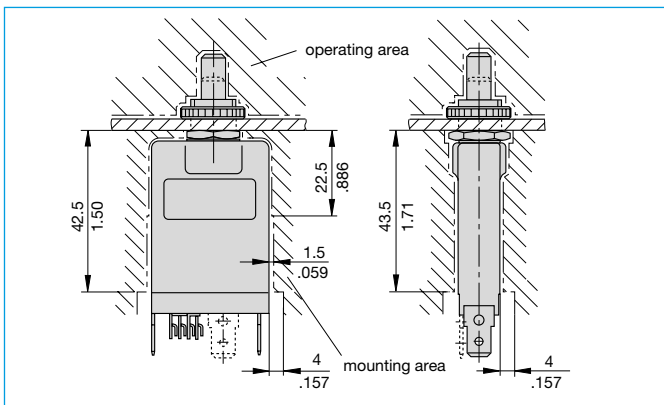

Typical time/current characteristics at +23 °C/+73.4 °F

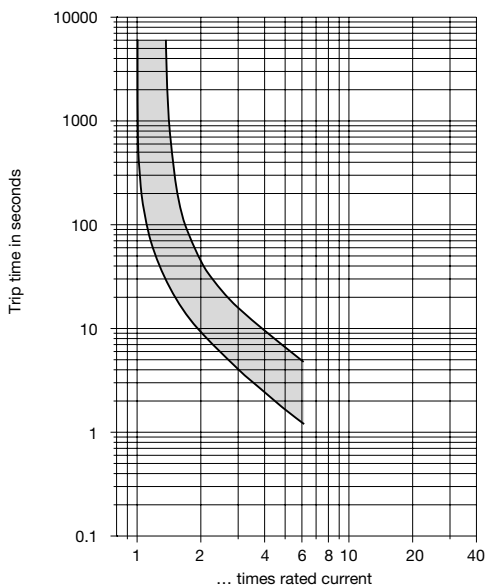

The time/current characteristic curve depends on the ambient temperature prevailing. In order to eliminate nuisance tripping, please multiply the circuit breaker current ratings by the derating factor shown below. See also section Technical information.

| Ambient temperature °F | -4 | +14 | +32 | +73.4 | +104 | +122 | +140 |
|------------------------|------|------|------|-------|------|------|------|
| °C | -20 | -10 | 0 | +23 | +40 | +50 | +60 |
| Derating factor | 0.76 | 0.84 | 0.92 | 1 | 1.08 | 1.16 | 1.24 |

Terminal design

-P10 0.05...7 A

See dimension diagram.

-P10 8...16 A

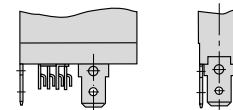

-P10-A3 0.05...16 A

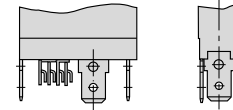

-L10 0.05...7 A

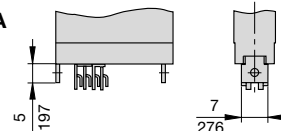

-L10 8...16 A

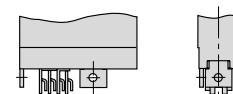

-L10-A3 0.05...16 A

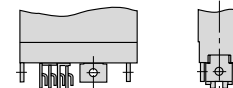

This is a metric design and millimeter dimensions take precedence ($\frac{mm}{inch}$)

Accessories

With 3/8" threadneck (-iG1)

Water splash cover, transparent Y 300 538 01 and knurled nut Y 300 628 01 X 200 799 01 (IP64)

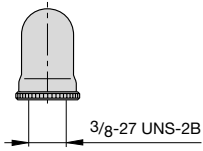

Water splash cover transparent with special knurled nut X 200 798 02 (IP64)

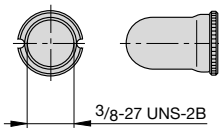

Hex nut with splash cover black without O ring X 210 739 01 (IP64) transparent splash cover X 201 296 03 (IP64)

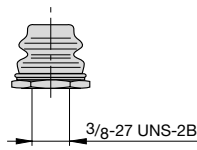

Separate hardware Hex nut Y 300 192 01

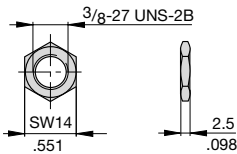

Knurled nut Y 307 117 02

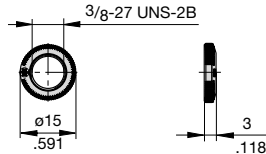

With M12 threadneck (-iG2)

Hex nut with splash cover, black X 201 296 01 without O ring (IP64) X 200 801 03 with O ring (IP66 and IP67) Water splash cover, transparent with knurled nut and O ring X 210 663 01 (IP64)

Hex nut with splash cover, transparent X 200 801 08 with O ring (IP66 and IP67)

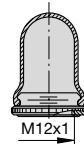

Hex nut Y 300 116 02

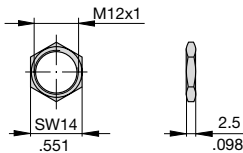

Knurled nut Y 302 065 01

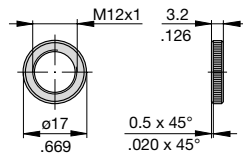

This is a metric design and millimeter dimensions take precedence ($\frac{\text{mm}}{\text{inch}}$)

All dimensions without tolerances are for reference only. In the interest of improved design, performance and cost effectiveness the right to make changes in these specifications without notice is reserved. Product markings may not be exactly as the ordering codes. Errors and omissions excepted.

