



Chipsmall Limited consists of a professional team with an average of over 10 year of expertise in the distribution of electronic components. Based in Hongkong, we have already established firm and mutual-benefit business relationships with customers from,Europe,America and south Asia,supplying obsolete and hard-to-find components to meet their specific needs.

With the principle of “Quality Parts,Customers Priority,Honest Operation,and Considerate Service”,our business mainly focus on the distribution of electronic components. Line cards we deal with include Microchip,ALPS,ROHM,Xilinx,Pulse,ON,Everlight and Freescale. Main products comprise IC,Modules,Potentiometer,IC Socket,Relay,Connector.Our parts cover such applications as commercial,industrial, and automotives areas.

We are looking forward to setting up business relationship with you and hope to provide you with the best service and solution. Let us make a better world for our industry!



## Contact us

Tel: +86-755-8981 8866 Fax: +86-755-8427 6832

Email & Skype: info@chipsmall.com Web: www.chipsmall.com

Address: A1208, Overseas Decoration Building, #122 Zhenhua RD., Futian, Shenzhen, China



NOTES: UNLESS OTHERWISE SPECIFIED;

1. ALL RESISTOR VALUES ARE IN OHMS, 1/16W, 5%
2. ALL JUMPER RESISTORS ARE 0 OHMS 0805 PACKAGE.
3. ALL CAPACITORS ARE 50VDC OR HIGHER.
4. THE ORIENTATION SOURCE OF A VOLTAGE IS REPRESENTED BY (  $\uparrow$  ), AND ALL REFERENCES TO THAT VOLTAGE ARE REPRESENTED BY (  $\overset{VCC}{\uparrow}$  ).

5 OUTLINED CIRCUIT NOT STUFFED.

6. COMPONENT VALUES SHOWN WITH AN ASTERISK (\*) FOLLOWING THE VALUE, MAY HAVE DIFFERENT VALUES OR MAY NOT BE STUFFED DEPENDING ON MODEL. SEE STUFFING CHART FOR CLARIFICATION.

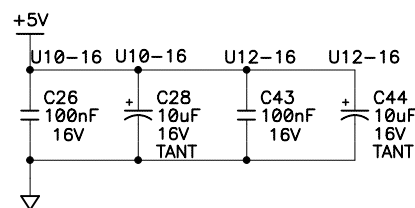
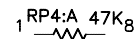
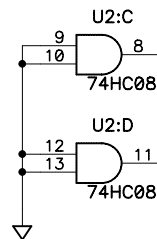
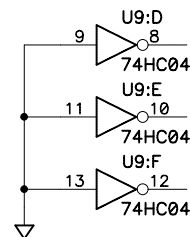
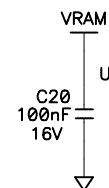
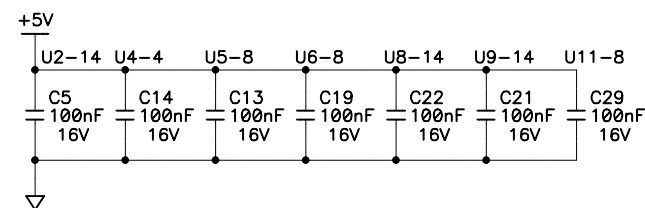
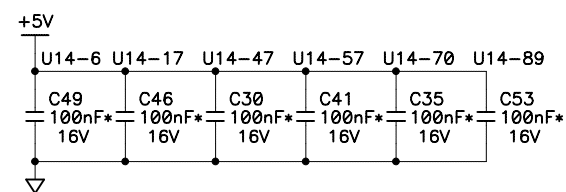
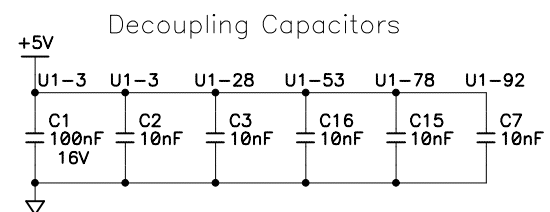
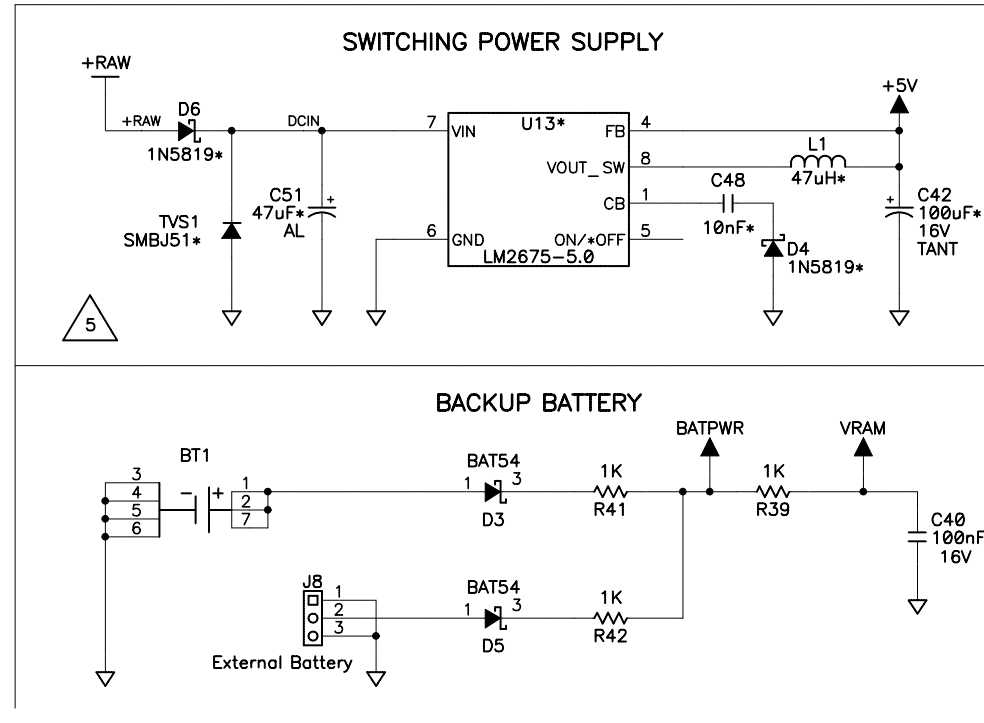

REVISION HISTORY

REVISION APPROVAL

REV	ECO	DESCRIPTION	PROJECT ENGINEER	APPROVAL DATE	DOCUMENT CONTROL	APPROVAL DATE
A	E11809	INITIAL RELEASE	XT	2/4/02	KIS	2/4/02
B	E11834	REMOVE UNUSED REFERENCES FOR CLARIFICATION	XT	2/15/02	KIS	2/15/02
C	E12084	REMOVE RT1, CHANGE R1 TO 11K (BATTERY CIRCUIT PG. 2)	XT	9/19/02	KIS	9/19/02
D	E12311	REMOVE PD5 FROM J1, REWIRE PD5 TO ETHRNET (U14).	XT	6/19/03	KIS	6/18/03
E	E12402	IMPROVE ETHERNET JACK. REMOVE CAPS, BETTER CONNECTOR.	XT	9/23/03	KF	9/23/03

TABLE A

REF DES	DEVICE	DEVICE VOLTAGE INFORMATION				DEVICE: FILTER CAP REF DES(s)
		GND	+5V	VRAM	NO CONNECTS	
U1	RABBIT 2000	2,27,39, 52,77,89	3,28,53,78,92			PIN3 - C14 + C15 C23, C24, C17, C16
U2	74HC08	7	14			C5
U3	74AHC1GU04	3	5			
U4	ETC811L	1	4			C14
U5	FLASH	24	8			C13
U6	SP483E	5	8			C19
U7	SRAM 512K X 8	16		32		C20
	SRAM 128K X 8	16		32		
U8	74HC125	7	14			C22
U9	74HC04	7	14			C21
U10	232A	15	16			C26, C28
U11	FLASH	24	8			C29
U12	232A	15	16			C43, C44
U13	LM2575-5.0				2-6,9,11,13,16, 19-24	
U14	RTL8019AS	14,28,44, 52,83,86	6,17,47, 57,70,89			C48, C44, C32, C45, C46, C49

COPYRIGHT 2003, Z-WORLD, INC.

APPEND THE FOLLOWING DOCUMENTS WHEN CHANGING THIS DOCUMENT:		DRAWING CONTENT:		TITLE	
		DRAWN BY: (INITIAL RELEASE)		SCHEMATIC DIAGRAM SR9150/9160 SMART STAR CPU	
		XUAN TRUONG	2/4/02		
		REVISED BY:		Z-WORLD 2900 SPAFFORD ST. DAVIS, CA 95616 530 - 757 - 4616	
		K.FREEMAN	9/23/03		
		APPROVALS: INITIAL RELEASE		SIZE	DWG NO.
		PROJECT ENGINEER:		<b>B</b>	090-0129
		XUAN TRUONG	2/4/02	SCALE	NONE
		ENGINEERING MANAGER:		RELEASE DATE	2/4/02
		R.MATTHEWS	2/4/02	SHEET	1 OF 5
		SIGNATURES		DATE	

U14: OPTIONAL 512K OR 128K

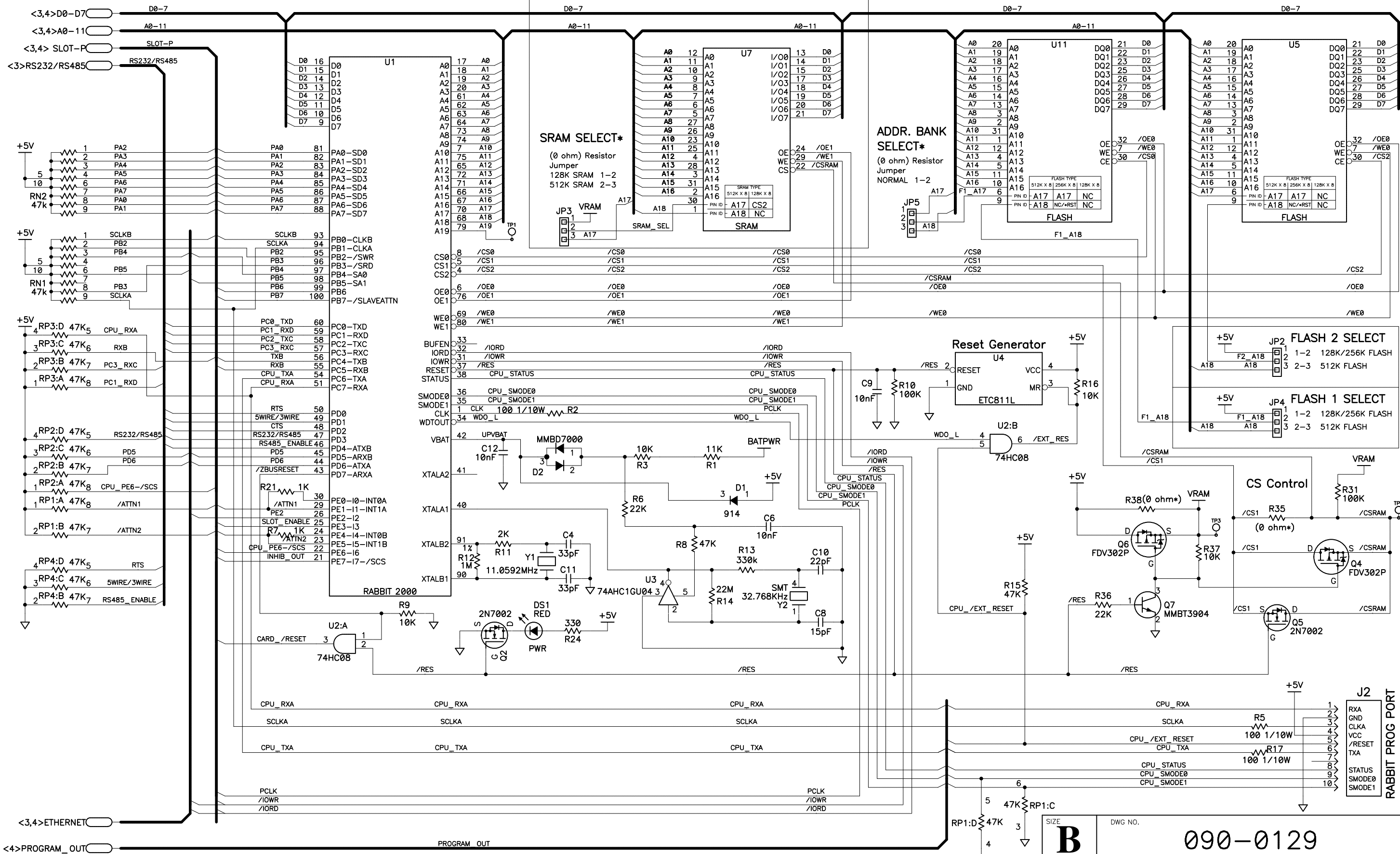

SIZE	DWG NO.
<b>B</b>	090-0129
SCALE	REV LTR
NONE	E
SHEET	OF
2	5



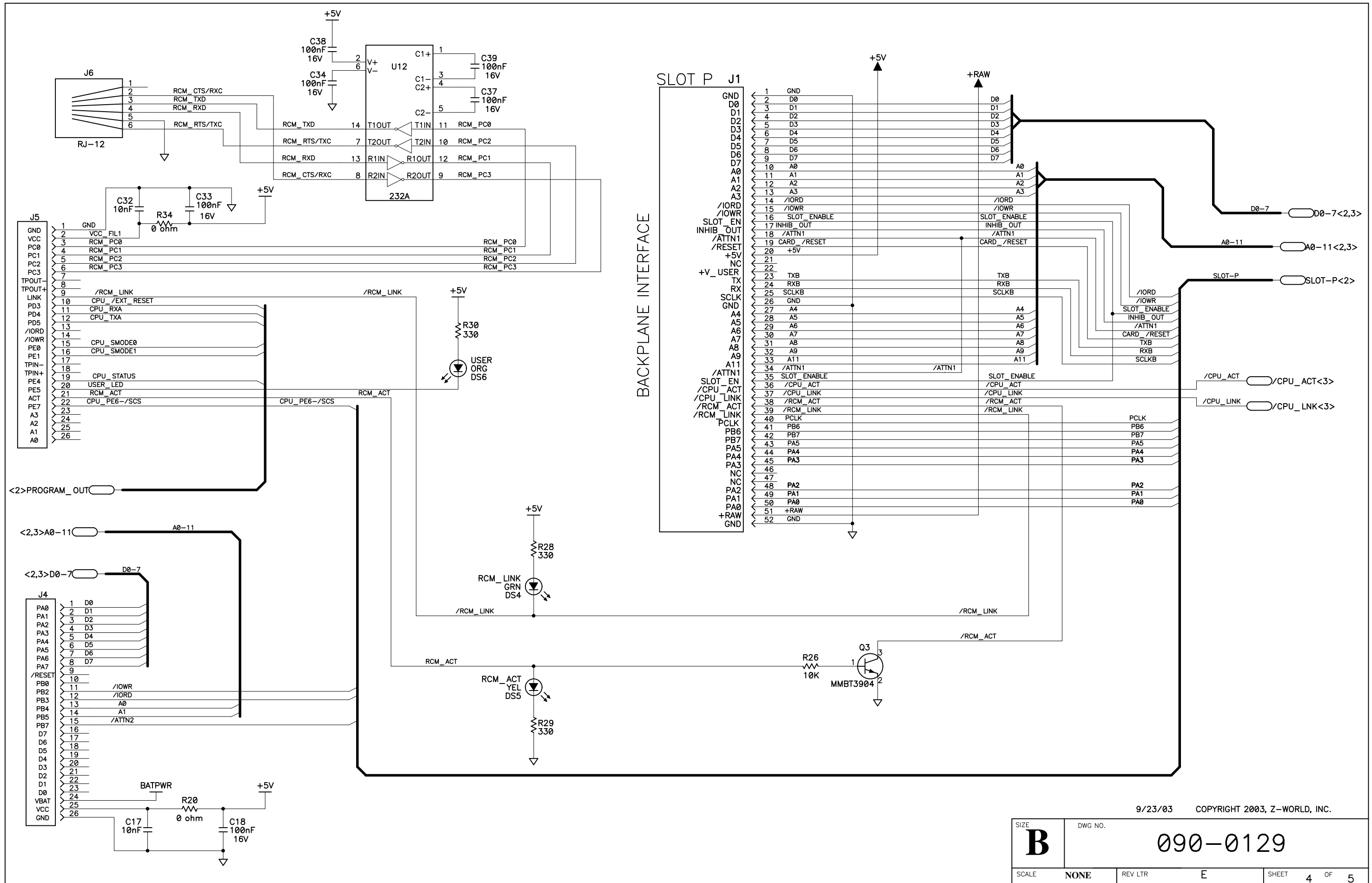

BACKPLANE INTERFACE

9/23/03 COPYRIGHT 2003, Z-WORLD, INC.

SIZE <b>B</b>	DWG NO. <b>090-0129</b>
SCALE <b>NONE</b>	REV LTR <b>E</b>
SHEET <b>4</b> OF <b>5</b>	

# STUFFING TABLE

CIRCUIT		PART	MODEL	
			SR9150	SR9160
POWER SUPPLY (PAGE 1)		TVS1	NOT INSTALLED	NOT INSTALLED
		C51	NOT INSTALLED	NOT INSTALLED
		C48	NOT INSTALLED	NOT INSTALLED
		C42	NOT INSTALLED	NOT INSTALLED
		D4, D6	NOT INSTALLED	NOT INSTALLED
		U13	NOT INSTALLED	NOT INSTALLED
		L1	NOT INSTALLED	NOT INSTALLED
SRAM (PAGE 2)		R35, R38	NOT INSTALLED	NOT INSTALLED
	MAIN	U7	128K SRAM	128K SRAM
	SRAM SELECT	JP3	ZERO ohm ACROSS PINS 1-2	ZERO ohm ACROSS PINS 1-2
FLASH (PAGE 2)	FLASH 1	U11	256K FLASH	256K FLASH
	FLASH 1 SELECT	JP4	ZERO ohm ACROSS PINS 1-2	ZERO ohm ACROSS PINS 1-2
	ADDR. BANK SELECT	JP5	ZERO ohm ACROSS PINS 1-2	ZERO ohm ACROSS PINS 1-2
	FLASH 2	U5	256K FLASH	256K FLASH
	FLASH 2 SELECT	JP2	ZERO ohm ACROSS PINS 1-2	ZERO ohm ACROSS PINS 1-2

CIRCUIT		PART	MODEL	
			SR9150	SR9160
ETHERNET (PAGE 3)		C50, C52	NOT INSTALLED	NOT INSTALLED
		C45, C47	10nF	NOT INSTALLED
		C31, C36	10pF	NOT INSTALLED
		C30, C35	100nF-16V	NOT INSTALLED
		C41, C46	100nF-16V	NOT INSTALLED
		C49, C53	100nF-16V	NOT INSTALLED
		Q1	3904 NPN	NOT INSTALLED
		DS2	GREEN LED	NOT INSTALLED
		DS3	YELLOW LED	NOT INSTALLED
		R43	0 ohm	NOT INSTALLED
		R40	200 ohm	NOT INSTALLED
		R33	1M	NOT INSTALLED
		R32	0 ohm	NOT INSTALLED
		R25, R27	330 ohm	NOT INSTALLED
		R23, R44	10K	NOT INSTALLED
		U14	RTL8019AS	NOT INSTALLED
		Y3	20 MHZ CRYSTAL	NOT INSTALLED
J7	RJ-45	NOT INSTALLED		

9/23/03    COPYRIGHT 2003, Z-WORLD, INC.

SIZE <b>B</b>	DWG NO. <b>090-0129</b>
SCALE NONE	REV LTR E
SHEET 5 OF 5	