



Chipsmall Limited consists of a professional team with an average of over 10 year of expertise in the distribution of electronic components. Based in Hongkong, we have already established firm and mutual-benefit business relationships with customers from,Europe,America and south Asia,supplying obsolete and hard-to-find components to meet their specific needs.

With the principle of “Quality Parts,Customers Priority,Honest Operation,and Considerate Service”,our business mainly focus on the distribution of electronic components. Line cards we deal with include Microchip,ALPS,ROHM,Xilinx,Pulse,ON,Everlight and Freescale. Main products comprise IC,Modules,Potentiometer,IC Socket,Relay,Connector.Our parts cover such applications as commercial,industrial, and automotives areas.

We are looking forward to setting up business relationship with you and hope to provide you with the best service and solution. Let us make a better world for our industry!



Contact us

Tel: +86-755-8981 8866 Fax: +86-755-8427 6832

Email & Skype: info@chipsmall.com Web: www.chipsmall.com

Address: A1208, Overseas Decoration Building, #122 Zhenhua RD., Futian, Shenzhen, China



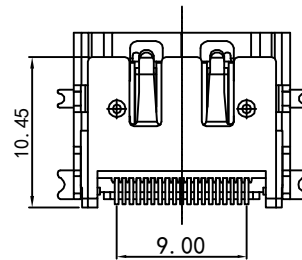
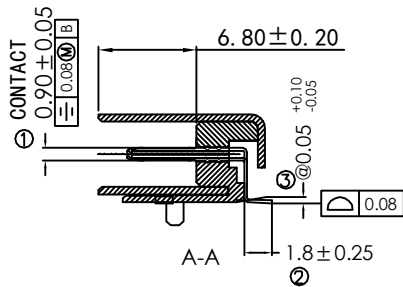
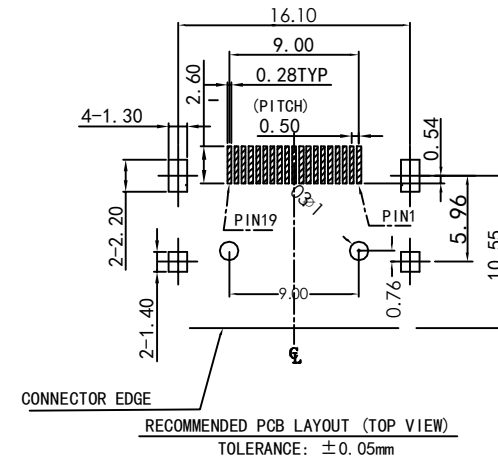
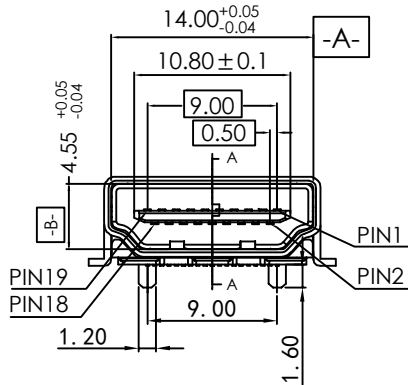
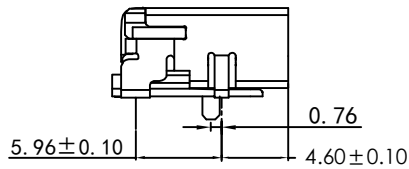
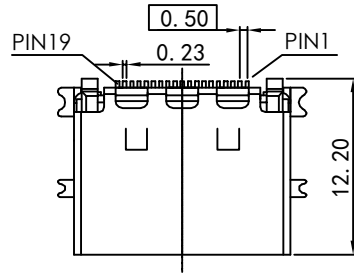
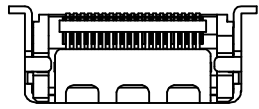

NOTE:

1.Material:

Terminal : Brass C2680-1/2H(HV120~140), T=0.2±0.02mm.

Shell : Brass ,T=0.5±0.02mm.

Housing : LCP(E130I)+30% G.F. (UL94-0), Black.

2.Plating:



Terminal: Au plated on contact area (see order information),
100u" Sn plated on solder tail area,
both over 50u" min. Ni underplated overall.

Shell : Gold Flash overall.

3.Mechanical Characteristics:

Insertion force : 4.5Kgf max.

Withdrawing force : 1Kgf ~ 4Kgf.

2017/04/06	Jody		Structural changes		A1
2012/03/06	XIE		NEW DWG		A0
DATE	DR.BY	ECN.NO.	DESCRIPTION	MARK	VER.
-TOLERANCES- UNLESS OTHERWISE SPECIFIED			CnC Tech,LLC		
			  TITLE: HDMI AF SMT 四脚SMT 带柱		
X.X	±0.25	X.X*	±3.00*	APPD:	PRODUCT NO: 2000-1-2-41-00-BK
X.XX	±0.20	X.XX*	±1.00*	CHECK:	DATE SCALE UNIT TYPE PAGE
X.XXX	±0.15	X.XXX*	±0.500*	DRAW:	2012/04/06 1:1 mm Z 1/1