



Chipsmall Limited consists of a professional team with an average of over 10 year of expertise in the distribution of electronic components. Based in Hongkong, we have already established firm and mutual-benefit business relationships with customers from,Europe,America and south Asia,supplying obsolete and hard-to-find components to meet their specific needs.

With the principle of “Quality Parts,Customers Priority,Honest Operation,and Considerate Service”,our business mainly focus on the distribution of electronic components. Line cards we deal with include Microchip,ALPS,ROHM,Xilinx,Pulse,ON,Everlight and Freescale. Main products comprise IC,Modules,Potentiometer,IC Socket,Relay,Connector.Our parts cover such applications as commercial,industrial, and automotives areas.

We are looking forward to setting up business relationship with you and hope to provide you with the best service and solution. Let us make a better world for our industry!



## Contact us

Tel: +86-755-8981 8866 Fax: +86-755-8427 6832

Email & Skype: info@chipsmall.com Web: www.chipsmall.com

Address: A1208, Overseas Decoration Building, #122 Zhenhua RD., Futian, Shenzhen, China



# SERPAC A-21

Electronics Enclosures

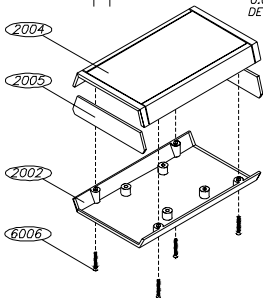
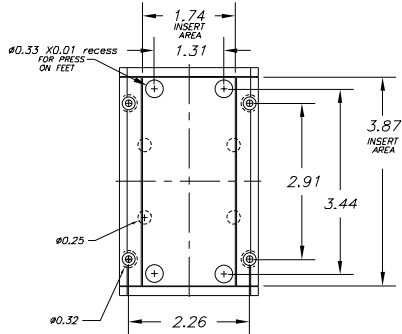
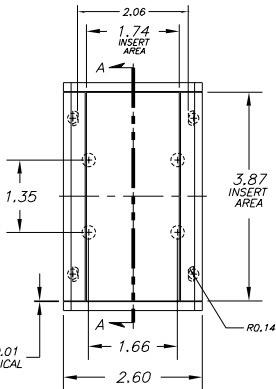
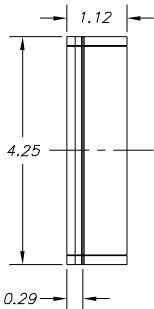

0.02 X 0.01  
DEEP TYPICAL

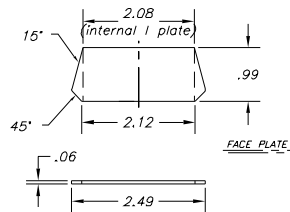
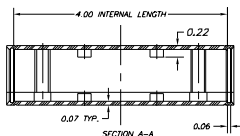
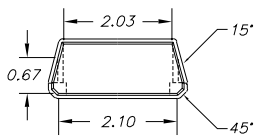

NOTES  
1. WHEN MACHINE OR 1 PLATES MODIFICATIONS ARE REQUIRED, USE THE CENTER OF THE ENCLOSURE TO DIMENSION.

10-07-98

ALL DIMENSIONS ± .010

PART NO.	DESCRIPTION	PART NO.	ACCESSORIES
2004	PLASTIC TOP	52	PRESS ON FEET
2005	PLASTIC END PANEL	2005IR	INFRARED PANELS
2002	PLASTIC BOTTOM	2005CL	CLEAR & TRANSPARENT RED PANELS
6006	SCREW	2006	9 VOLT BATTERY ACCESS PANEL
		2007	PLASTIC BATTERY COVER
		2005DB9	9 PIN CONNECTOR
		2005DB25	25 PIN CONNECTOR