



Chipsmall Limited consists of a professional team with an average of over 10 year of expertise in the distribution of electronic components. Based in Hongkong, we have already established firm and mutual-benefit business relationships with customers from,Europe,America and south Asia,supplying obsolete and hard-to-find components to meet their specific needs.

With the principle of “Quality Parts,Customers Priority,Honest Operation,and Considerate Service”,our business mainly focus on the distribution of electronic components. Line cards we deal with include Microchip,ALPS,ROHM,Xilinx,Pulse,ON,Everlight and Freescale. Main products comprise IC,Modules,Potentiometer,IC Socket,Relay,Connector.Our parts cover such applications as commercial,industrial, and automotives areas.

We are looking forward to setting up business relationship with you and hope to provide you with the best service and solution. Let us make a better world for our industry!



Contact us

Tel: +86-755-8981 8866 Fax: +86-755-8427 6832

Email & Skype: info@chipsmall.com Web: www.chipsmall.com

Address: A1208, Overseas Decoration Building, #122 Zhenhua RD., Futian, Shenzhen, China



Selector Chart For Fuses

Resettable Polymeric PTC					
	<i>Fuses cross to competitive resettable devices. See our online cross list at http://www.schurterinc.com/cross.htm</i>				
Series	PFMD	PFSM	PFRA	PFRX	PFST/PFLT
Page	106 -108	109 - 111	112 -115	116 -118	119 - 122
Mounting terminals	surface mount	surface mount	radial leaded	radial leaded	strap (standard or slotted)
Hold current I_H @ 23°C	200mA to 1.1A	300mA to 2.5A	100mA to 9A	1.1A to 3.75A	1A to 4.2A

Non-Resettable Surface Mount	 NEW EIA 1206	 With or without fuse clips			 NEW Time-lag version OMT	 New MSB / MKT Time lag versions
	Series / Voltage	MGA 125V	SFP 63V; SFC 63V	OMF 63V	OMF 125	OMF/OMT 125/250V
Page	127	128-129	130-131	132-133	134	135-136
Rated current	200mA to 5A	1A-5A; 800mA-4A	63mA to 10A	63mA to 10A	250mA to 4A	125mA to 7A
Time/current action	quick-acting	quick-acting	quick-acting	quick-acting	quick-acting or time-lag	quick-acting or time-lag

Through-Hole		 NEW Hermetically sealed		 NEW UL listed versions MSF-U & MST-U	 MXT with high breaking capacity	 NEW With radial leads
	Series / Voltage	MSA 125V	MGL 125V	MSF 125V	MSF 250V	MST/MXT 250V
Page	137	138	139	140	141/142	143
Rated current	63mA to 15A	200mA to 5A	100mA to 5A	40mA to 5A	50mA to 6.3A	250mA to 6.3A
Time/current action	quick-acting	quick-acting	quick-acting	quick-acting	time-lag	quick-acting or time-lag

5 x 20mm				
	<i>Quick-acting and time-lag characteristics available, with low, medium or high breaking capacities. Pigtail leads optional.</i>			
Series	SA/SP/SPT/FSM	FSF/FST/FTT/FSM	All series	Fuse kits for prototypes
Page	144 -154	144 - 154	144 - 154	156

Telecom Surge-Tolerant for Telecom applications						
	Series / Voltage	OSU 125V	OSU / OMT 250V	MSU 125V	MSU 250V	FRT 250V
Page	162	162	163	163	164	165-166
Rated current	250mA to 3.15A	250mA to 3.15A	250mA to 3.15A	250mA to 3.15A	250mA to 3.15A	250mA to 3.15A
Time/current action	quick-acting	quick-acting	quick-acting	quick-acting	quick-acting	quick-acting

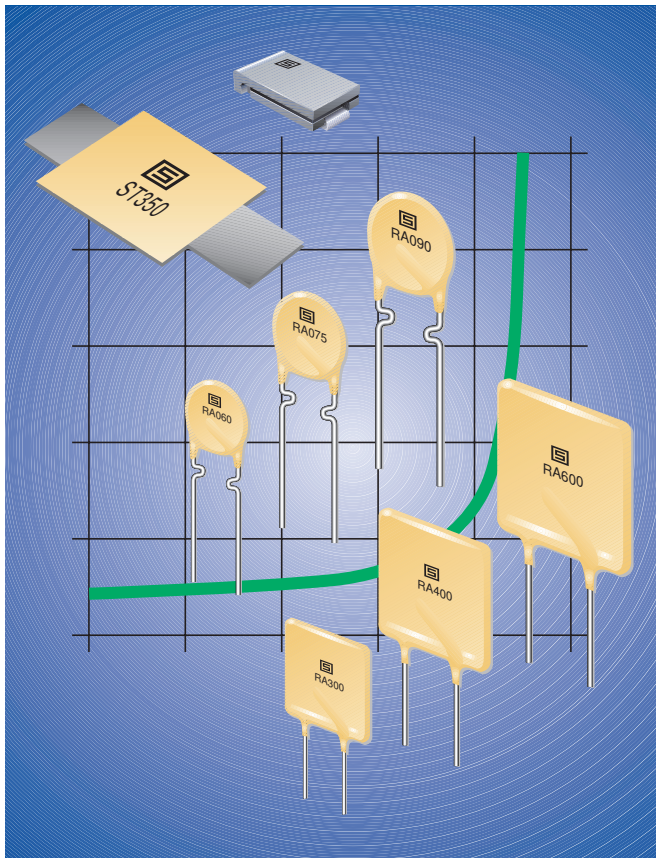

HOW POLYMERIC RESETTABLE OVERCURRENT PROTECTORS WORK

The conductive carbon black filler material in the polymeric device is dispersed in a polymer that has a crystalline structure. The crystalline structure densely packs the carbon particles into its crystalline boundary so they are close enough together to allow current to flow through the polymer insulator via these carbon “chains.”

When the conductive plastic material is at normal room temperature, there are numerous carbon chains forming conductive paths through the material.

Under fault conditions, excessive current flows through the polymeric device. I^2R heating causes the conductive plastic material’s temperature to rise. As this self heating continues, the material’s temperature continues to rise until it exceeds its phase transformation temperature. As the material passes through this phase transformation temperature, the densely packed crystalline polymer matrix changes to an amorphous structure. This phase change is accompanied by a small expansion. As the conductive particles move apart from each other, most of them no longer conduct current and the resistance of the device increases sharply.

The material will stay “hot,” remaining in this high resistance state as long as the power is applied. The device will remain latched, providing continuous protection, until the fault is cleared and the power is removed. Reversing the phase transformation allows the carbon chains to re-form as the polymer re-crystallizes. The resistance quickly returns to its original value.



RESETTABLE CIRCUIT PROTECTION

When it comes to Polymeric Positive Temperature Coefficient (PPTC) circuit protection, you now have a choice. If you need a reliable source, look to polymeric resettable fuses from SCHURTER.

Polymeric fuses are made from a conductive plastic formed into thin sheets, with electrodes attached to either side. The conductive plastic is manufactured from a non-conductive crystalline polymer and a highly conductive carbon black. The electrodes ensure even distribution of power through the device, and provide a surface for leads to be attached or for custom mounting.

The phenomenon that allows conductive plastic materials to be used for resettable overcurrent protection devices is that they exhibit a very large non-linear Positive Temperature Coefficient (PTC) effect when heated. PTC is a characteristic that many materials exhibit whereby resistance increases with temperature. What makes the polymeric conductive plastic material unique is the magnitude of its resistance increase. At a specific transition temperature, the increase in resistance is so great that it is typically expressed on a log scale.

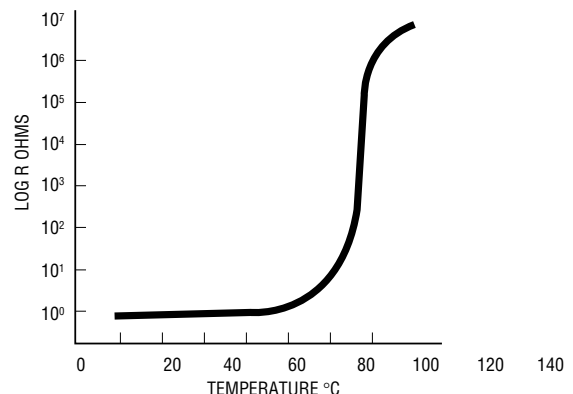

PRODUCT SELECTION

To select the correct polymeric circuit protection device, complete the information listed below for the application, and then refer to the resettable overcurrent protector data sheets.

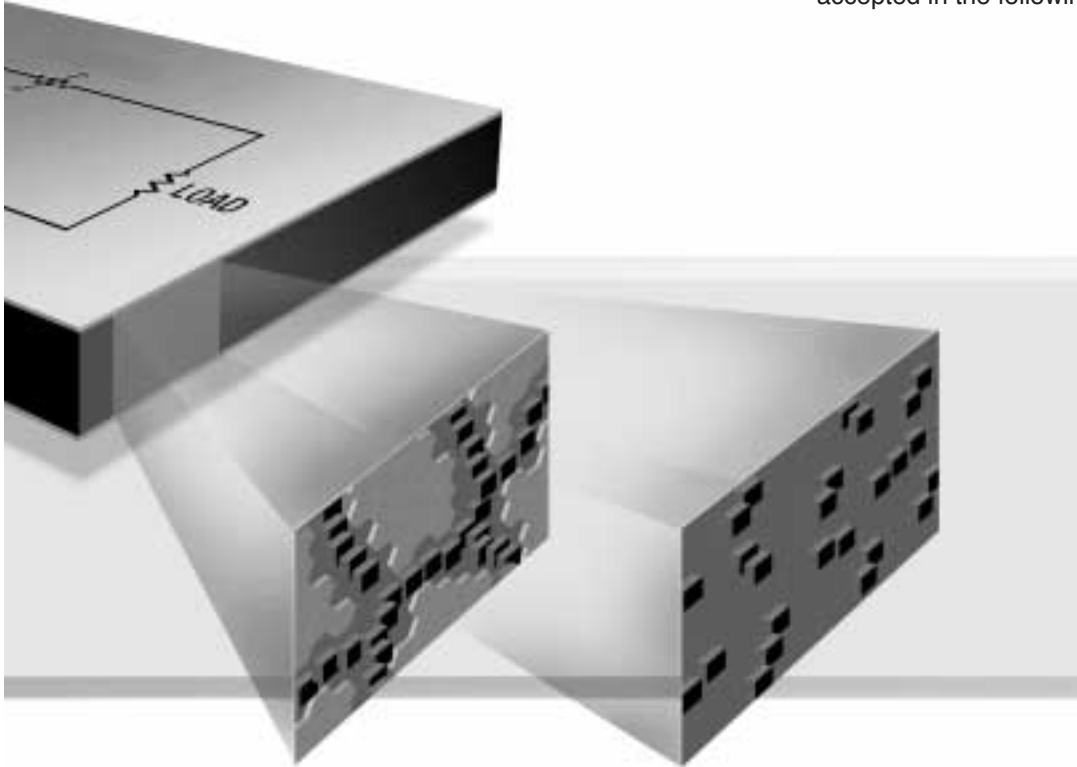

APPLICATIONS

The benefits of polymeric Resettable Overcurrent Protectors are being recognized by more and more design engineers, and new applications are being discovered every day.

The use of polymeric types of devices have been widely accepted in the following applications and industries:

1. Determine the normal operating current:
_____ amps
2. Determine the maximum circuit voltage (V_{max}): _____ volts
3. Determine the fault current (I_{max}):
_____ amps
4. Determine the operating temperature range:
Minimum Temperature: _____ °C
Maximum Temperature: _____ °C
5. Select a product family so that the maximum rating for V_{max} and I_{max} is higher than the maximum circuit voltage and fault current in the application.
6. Using the I_{hold} vs. Temperature Table on the product family data sheet, select the polymeric device at the maximum operating temperature with an I_{hold} greater than or equal to the normal operating current.
7. Verify that the selected device will trip under fault conditions by checking in the I_{trip} table that the fault current is greater than I_{trip} for the selected device, at the lowest operating temperature.
8. Order samples and test in application.

- Personal computers
- Laptop computers
- Personal digital assistants
- Transformers
- Small and medium electric motors
- Audio equipment and speakers
- Test and measurement equipment
- Security and fire alarm systems
- Medical electronics
- Personal care products
- Point-of-sale equipment
- Industrial controls
- Automotive electronics and harness protection
- Marine electronics
- Battery-operated toys

Schurter's resettable fuses cross to many like products already on the market. See our online cross list at www.schurterinc.com/cross.htm.

PFMD Polymeric PTC Resettable Fuse – Surface Mount



Typical Time to Trip at 23 °C

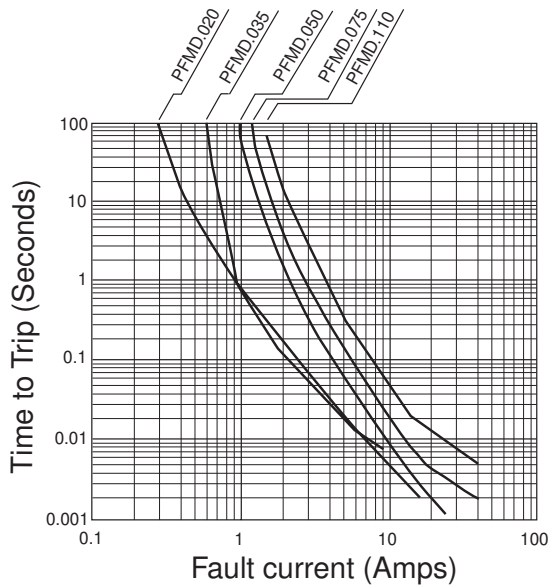

NEW



- High Density Circuit Board Application:
Hard disk drives,
PC motherboards
PC peripherals
Point-of-sale (POS) equipment
PCMCIA cards

- Packaged per EIA 481-2 standard

Approvals:

UL recognition
CSA pending
TÜV approval

Dimensions

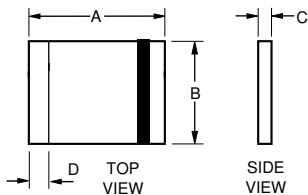

Dimensions in mm / (inch)

Solder Pad Layouts

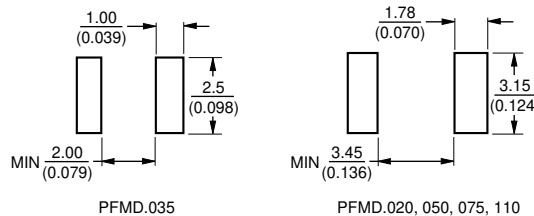

Typical Part Marking

Represents total content. Layout may vary.

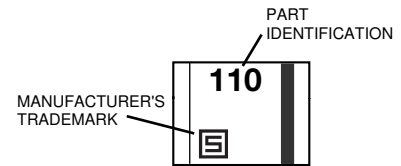

Technical Data

Operating/Storage Temperature	-40°C to +85°C	
Maximum Device Surface Temperature in Tripped State	125°C	
Passive Aging	+85°C, 1000 hours	±5% typical resistance change
Humidity Aging	+85°C, 85% R.H. 1000 hours	±5% typical resistance change
Thermal Shock	+125°C/-40°C 10 times	±10% typical resistance change
Mechanical Shock	MIL-STD-202, Method 213, Condition 1 (100g, 6 seconds)	No resistance change
Solvent Resistance	MIL-STD-202, Method 215	No change
Vibration	MIL-STD-883C, Method 2007.1, Condition A	No change
Terminal material	Solder-plated copper	
Termination pad solderability	Meets EIA Specification RS-186-9E, ANSI/J-STD-002 Cat.3	

Test Procedures And Requirements

Test	Test Conditions	Accept/Reject Criteria
Visual/Mech.	Verify dimensions and materials	Per PF physical description
Resistance	In still air @ 23°C	$R_{min} \leq R \leq R_{max}$
Time to Trip	At 8 Amps, V_{max} , 23°C	$T \leq \text{max. time to trip (seconds)}$
Hold Current	30 min. at I_{hold}	No trip
Trip Cycle Life	V_{max} , I_{max} , 100 cycles	No arcing or burning
Trip Endurance	V_{max} , 48 hours	No arcing or burning

PFMD Technical Data, continued



Electrical Characteristics

Model	I max. Amps	V max. Volts	I _{hold}	I _{trip}	Initial Resistance		Max. Time To Trip at 23°C		Tripped Power Dissipation
			Amperes at 23°C		Ohms at 23°C		Amps	Seconds	Watts at 23°C
			Hold	Trip	R Min.	R ₁ Max.			
PFMD.020.2	10	30.0	0.20	0.40	0.40	5.00	8.0	0.02	0.8
PFMD.035.2	40	6.0	0.35	0.70	0.32	1.30	8.0	0.10	0.6
PFMD.050.2	40	15.0	0.50	1.00	0.15	1.00	8.0	0.15	0.8
PFMD.075.2	40	13.2	0.75	1.50	0.11	0.45	8.0	0.20	0.8
PFMD.110.2	40	6.0	1.10	2.20	0.04	0.21	8.0	0.30	0.8

Product Dimensions

Model	A		B		C		D
	Min.	Max.	Min.	Max.	Min.	Max.	Min.
PFMD.020.2	4.37	4.73	3.07	3.41	0.56	0.81	0.30
PFMD.035.2	3.00	3.43	2.35	2.80	0.38	0.62	0.35
PFMD.050.2	4.37	4.73	3.07	3.41	0.38	0.62	0.30
PFMD.075.2	4.37	4.73	3.07	3.41	0.38	0.62	0.30
PFMD.110.2	4.37	4.73	3.07	3.41	0.38	0.62	0.30

How to Order

PFMD.020.2

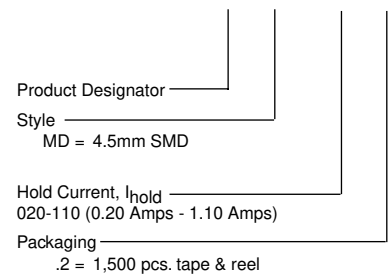

Solder Reflow And Rework Recommendations

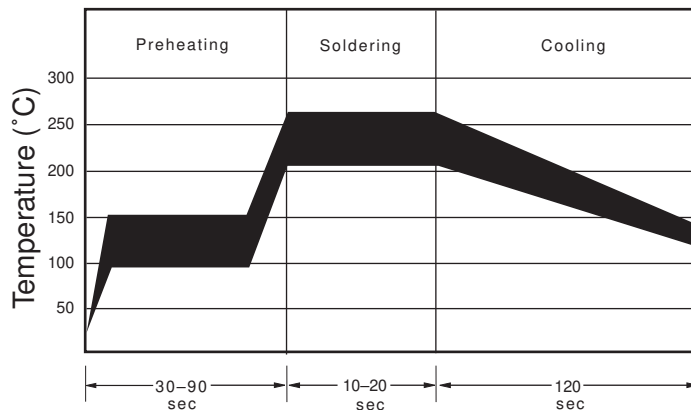

- Packaging options:
- TAPE & REEL: PFMD.035.2 = 3000 pcs per reel
All other models = 1500 pcs. per reel.

NOTE:

- PFMD models can be waved soldered and reworked.
- If reflow temperatures exceed the recommended profile, devices may not meet the performance requirements.

Thermal Derating Chart - I_{hold} (Amps)*

Part No.	Ambient Operating Temperature									
	-40°C	-20°C	0°C	23°C	40°C	50°C	60°C	70°C	85°C	
PFMD.020.2	0.29 / 0.58	0.26 / 0.52	0.23 / 0.46	0.20 / 0.40	0.17 / 0.34	0.15 / 0.30	0.14 / 0.28	0.12 / 0.24	0.10 / 0.20	
PFMD.035.2	0.47 / 0.94	0.45 / 0.90	0.40 / 0.80	0.35 / 0.70	0.30 / 0.60	0.28 / 0.56	0.24 / 0.48	0.21 / 0.42	0.18 / 0.36	
PFMD.050.2	0.77 / 1.54	0.68 / 1.36	0.59 / 1.18	0.50 / 1.00	0.44 / 0.88	0.40 / 0.80	0.37 / 0.74	0.33 / 0.66	0.29 / 0.58	
PFMD.075.2	1.15 / 2.30	1.01 / 2.02	0.88 / 1.76	0.75 / 1.50	0.65 / 1.30	0.60 / 1.20	0.55 / 1.10	0.49 / 0.98	0.43 / 0.86	
PFMD.110.2	1.59 / 3.18	1.43 / 2.86	1.26 / 2.52	1.10 / 2.20	0.95 / 1.90	0.87 / 1.74	0.80 / 1.60	0.71 / 1.42	0.60 / 1.20	

*I_{trip} = 2 • I_{hold}

Schurter's resettable fuses cross to many like products already on the market. See our online cross list at www.schurterinc.com/cross.htm

Tape Dimension Identifiers	PFMD 020, 050, 075, 110, per EIA-481-2	PFMD 035 per EIA 481-2
W	12 ± 0.3	8 ± 0.3
P ₀	4.0 ± 0.10	4.0 ± 0.10
P ₁	8.0 ± 0.10	4.0 ± 0.10
P ₂	2.0 ± 0.05	2.0 ± 0.05
A ₀	3.5 ± 0.23	2.8 ± 0.1
B ₀	5.1 ± 0.15	3.5 ± 0.1
B ₁ max.	5.9	4.35
D ₀	1.5 + 0.1/ - 0	1.5 + 0.1/ - 0
F	5.5 ± 0.05	3.5 ± 0.05
E ₁	1.75 ± 0.10	1.75 ± 0.10
E ₂ min.	10.25	6.25
T max.	0.6	0.6
T ₁ max.	0.1	0.1
K ₀	0.9 ± 0.15	1.1 ± 0.05
Leader min.	390	390
Trailer min.	160	160
Reel Dimension Identifiers		
A max.	185	185
N min.	50	50
W ₁	12.4 + 2.0/ - 0	8.4 + 1.5/ - 0
W ₂ max.	18.4	14.4

DIMENSIONS: MM

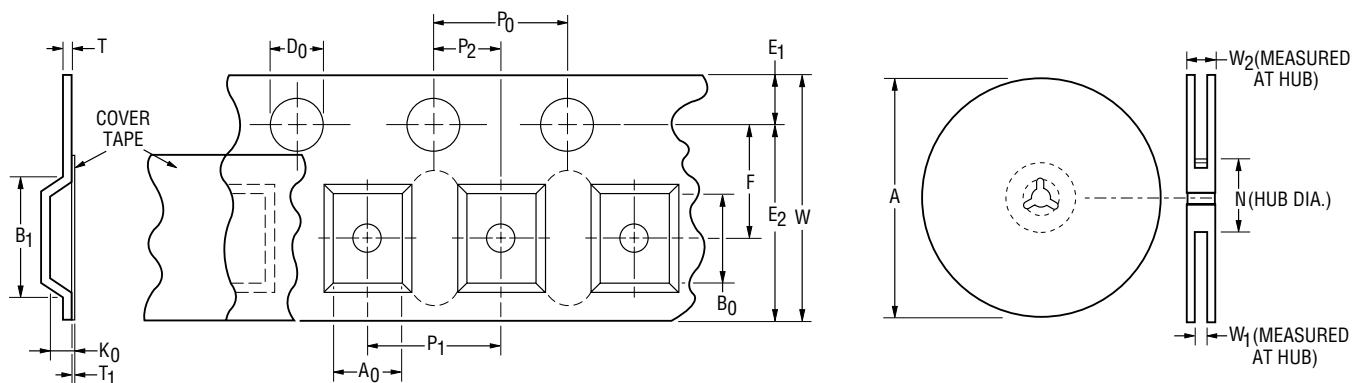

Specifications are subject to change without notice.

PFSM Polymeric PTC Resettable Fuse – Surface Mount



Typical Time to Trip at 23°C

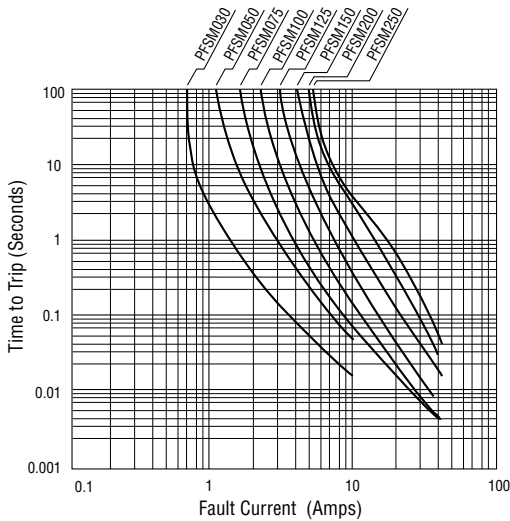

NEW



- Fully compatible with current industry standards
- Packaged per EIA 481-2 standard
- Applications: Almost anywhere there is a low voltage power supply and a load to be protected, including: computers & peripherals, general electronics, automotive applications

Approvals:

UL	recognition	File #E172175
CSA	acceptance	File #CA702083
TÜV	certification	File #R9872200

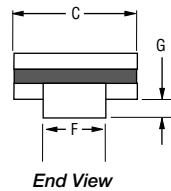
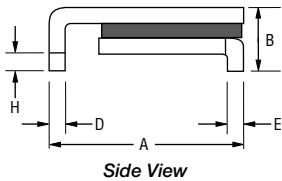

Typical Part Marking
Represents total content. Layout may vary.

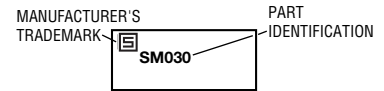

Recommended Pad Layout

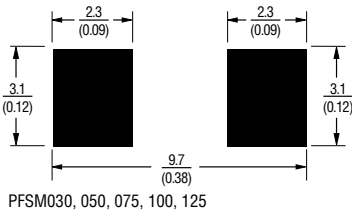

Recommended Pad Layout

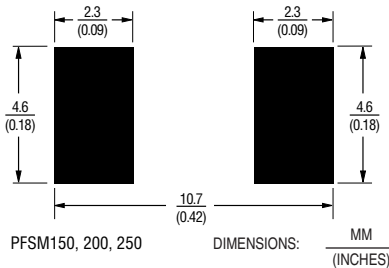

Technical Data

Operating/Storage Temperature	-40°C to +85°C	
Maximum Device Surface Temperature in Tripped State	125°C	
Passive Aging	+85°C, 1000 hours	±5% typical resistance change
Humidity Aging	+85°C, 85% R.H. 1000 hours	±5% typical resistance change
Thermal Shock	+125°C/-40°C 10 times	±10% typical resistance change
Mechanical Shock	MIL-STD-202, Method 213, Condition 1 (100g, 6 seconds)	No resistance change
Solvent Resistance	MIL-STD-202, Method 215	No change
Vibration	MIL-STD-883C, Method 2007.1, Condition A	No change

Test Procedures And Requirements

Test	Test Conditions	Accept/Reject Criteria
Visual/Mech.	Verify dimensions and materials	Per PF physical description
Resistance	In still air @ 23°C	Rmin ≤ R ≤ Rmax
Time to Trip	At specified current, Vmax, 23°C	T ≤ max. time to trip (seconds)
Hold Current	30 min. at Ihold	No trip
Trip Cycle Life	Vmax, Imax, 100 cycles	No arcing or burning
Trip Endurance	Vmax, 48 hours	No arcing or burning



Electrical Characteristics

Model	I max. Amps	V max. Volts	I _{hold}	I _{trip}	Initial Resistance		1 Hour (R1) Post-Reflow Resistance	Max. Time To Trip at 23°C		Tripped Power Dissipation
			Amperes at 23°C		Ohms at 23°C		Ohms at 23°C	Amps	Seconds	Watts at 23°C
			Hold	Trip	Min.	Max.	Max.		Max.	Nom.
PFSM030.2	10	60	0.30	0.60	0.90	-	4.80	1.5	3.0	1.7
PFSM050.2	10	30	0.50	1.00	0.35	-	1.40	2.5	4.0	1.7
PFSM075.2	40	30	0.75	1.50	0.27	-	1.00	8.0	0.30	1.7
PFSM100.2	40	15	1.10	2.20	0.12	-	0.48	8.0	0.50	1.7
PFSM125.2	40	15	1.25	2.50	0.07	-	0.25	8.0	2.0	1.7
PFSM150.2	40	15	1.50	3.00	0.06	-	0.25	8.0	5.0	1.9
PFSM200.2	40	15	2.00	4.00	0.05	-	0.125	8.0	12.0	1.9
PFSM250.2	40	15	2.50	5.00	0.035	-	0.085	8.0	25.0	1.9

Packaging options:

TAPE & REEL: PFSM.030 to PFSM.125 = 2000 pcs. per reel; PFSM.150 to PFSM.250 = 1500 pcs. per reel.

Product Dimensions

Model	A		B		C		D		E		F		G		H	
	Min.	Max.	Min.	Max.	Min.	Max.	Min.	Max.	Min.	Max.	Min.	Max.	Min.	Max.	Min.	Max.
PFSM030.2	6.73	7.98		3.18		5.44	0.56	0.71	0.56	0.71	2.16	2.41	0.66	1.37	0.43	
PFSM050.2	6.73	7.98		3.18		5.44	0.56	0.71	0.20	0.30	2.16	2.41	0.66	1.37	0.43	
PFSM075.2	6.73	7.98		3.18		5.44	0.56	0.71	0.56	0.71	2.16	2.41	0.66	1.37	0.43	
PFSM100.2	6.73	7.98		3.00		5.44	0.56	0.71	0.56	0.71	2.16	2.41	0.66	1.37	0.43	
PFSM125.2	6.73	7.98		3.00		5.44	0.56	0.71	0.56	0.71	2.16	2.41	0.66	1.37	0.43	
PFSM150.2	8.00	9.50		3.00		6.71	0.56	0.71	0.56	0.71	3.68	3.94	0.66	1.37	0.43	
PFSM200.2	8.00	9.50		3.00		6.71	0.56	0.71	0.56	0.71	3.68	3.94	0.66	1.37	0.43	
PFSM250.2	8.00	9.50		3.00		6.71	0.56	0.71	0.56	0.71	3.68	3.94	0.66	1.37	0.43	

DIMENSIONS = MM

Solder Reflow And Rework Recommendations



Solder reflow

- Recommended reflow methods: IR, vapor phase oven, hot air oven.
- Devices are not designed to be wave soldered to the bottom side of the board.
- Gluing the devices is not recommended.
- Recommended maximum paste thickness is 0.25 mm (.010 inch).
- Devices can be cleaned using standard industry methods and solvents.

Note: If reflow temperatures exceed the recommended profile, devices may not meet the performance requirements

Rework

- A device should not be reworked.

Thermal Derating Chart - I_{hold} (Amps)*

Model	Ambient Operating Temperature								
	-40°C	-20°C	0°C	23°C	40°C	50°C	60°C	70°C	85°C
PFSM030.2	0.45	0.40	0.35	0.30	0.25	0.23	0.20	0.17	0.14
PFSM050.2	0.76	0.67	0.59	0.50	0.42	0.38	0.33	0.29	0.23
PFSM075.2	1.13	1.01	0.88	0.75	0.62	0.56	0.50	0.44	0.34
PFSM100.2	1.66	1.47	1.29	1.10	0.91	0.83	0.73	0.64	0.50
PFSM125.2	1.89	1.68	1.46	1.25	1.04	0.94	0.83	0.73	0.56
PFSM150.2	2.27	2.01	1.76	1.50	1.25	1.13	0.99	0.87	0.68
PFSM200.2	3.02	2.68	2.34	2.00	1.66	1.50	1.32	1.16	0.90
PFSM250.2	3.78	3.35	2.93	2.50	2.08	1.88	1.65	1.45	1.13

*I_{trip} = 2 • I_{hold}

How To Order

Product Designator **PF SM . 030 . 2**

Style _____

SM = Surface Mount Component

Hold Current, I_{hold} _____
030-250 (0.30 Amps - 2.50 Amps)

Packaging Options _____
Packaged per EIA 481-2
.2 = Tape and Reel

Schurter's resettable fuses cross to many like products already on the market. See our online cross list at www.schurterinc.com/cross.htm

PFSM Tape and Reel Specifications



Tape Dimension Identifiers	PFSM 030, 050, 075, 100, 125 per EIA-481-2	PFSM 150, 200, 250 per EIA 481-2
W	16 ± 0.3	16 ± 0.3
P ₀	4.0 ± 0.10	4.0 ± 0.10
P ₁	8.0 ± 0.10	12.0 ± 0.10
P ₂	2.0 ± 0.10	2.0 ± 0.10
A ₀	5.7 ± 0.10	6.9 ± 0.10
B ₀	8.1 ± 0.15	10.0 ± 0.10
B ₁ max.	9.1	11.0
D ₀	1.5 + 0.1/ - 0	1.5 + 0.1/ - 0
F	7.5 ± 0.10	7.5 ± 0.10
E ₁	1.75 ± 0.10	1.75 ± 0.10
E ₂ min.	14.25	14.25
T max.	0.4	0.4
T ₁ max.	0.1	0.1
K ₀	3.4 ± 0.15	3.5 ± 0.10
Leader min.	390	390
Trailer min.	160	160
Reel Dimension Identifiers		
A max.	360	360
N min.	50	50
W ₁	16.4 + 2.0/ - 0	16.4 + 2.0/ - 0
W ₂ max.	22.4	22.4

DIMENSIONS:

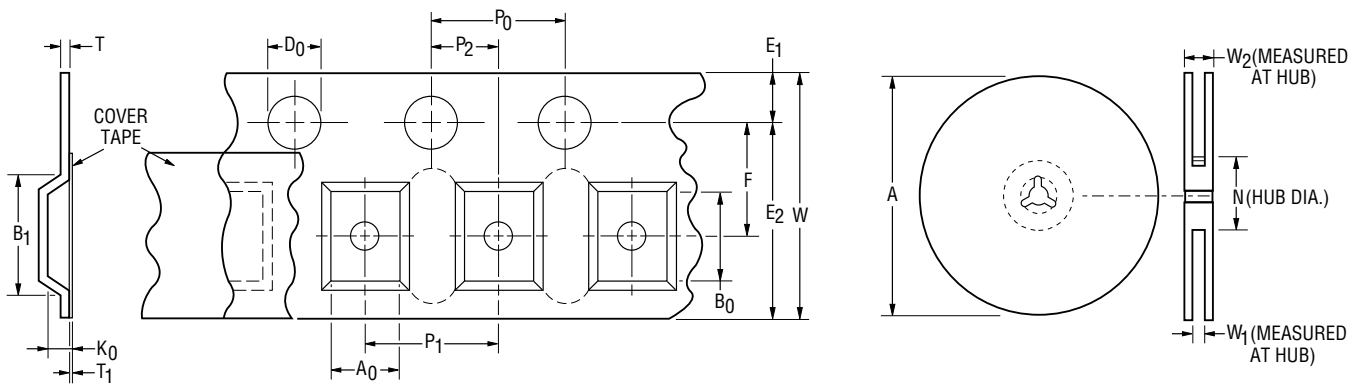

Specifications are subject to change without notice.

PFRA Polymeric PTC Resettable Fuse - Radial Leaded

Typical Time to Trip at 23°C

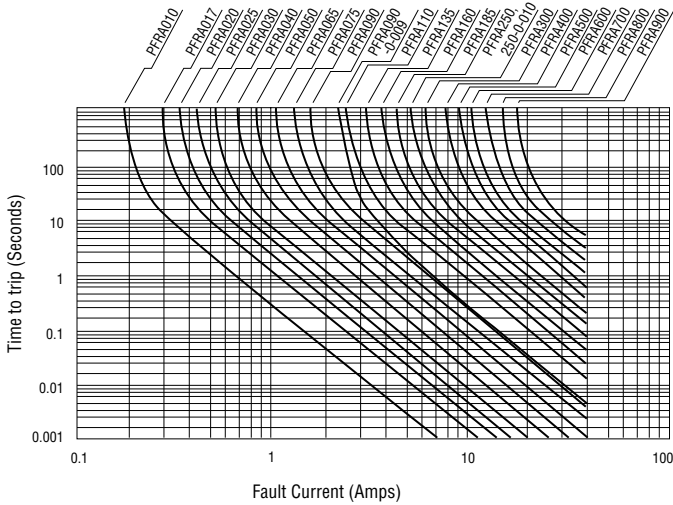

NEW

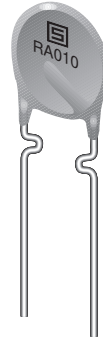

- Cured, flame retardant epoxy polymer insulating material meets UL 94V-0 requirements
- Bulk packaging, tape and reel and Ammo-Pak available on most models
- Applications: Almost anywhere there is a low voltage power supply and a load to be protected, including: computers & peripherals, general electronics, automotive applications

Approvals*

- UL recognition, file #E172175
.1A - 9A/30V (.1A-9A/60V pending)
- CSA acceptance, file #CA702083
[.1A - .9A/60V; .9A(.009) to 9A/30V]
- TÜV certification, file #R9872200
[.1A - .9A/60V; .9A(.009) to 9A/30V]

* rated amps at hold current I_{hold}

Package 1

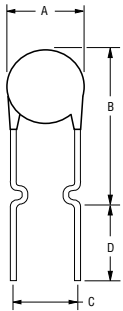

Package 2

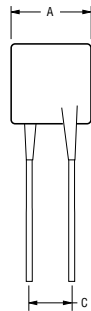

Package 3

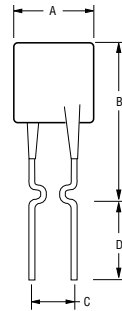

Typical Part Marking
Represents total content. Layout may vary.

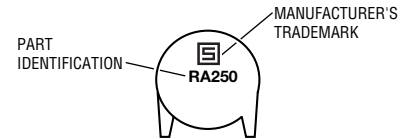

NOTE: Kinked lead option is available for board standoff. Contact factory for details.
Shape changes from round to square starting with PFRA.250.

Technical Data

Operating/Storage Temperature	-40°C to +85°C	
Maximum Device Surface Temperature in Tripped State	125°C	
Passive Aging	+85°C, 1000 hours	±5% typical resistance change
Humidity Aging	+85°C, 85% R.H. 1000 hours	±5% typical resistance change
Thermal Shock	+125°C/-40°C 10 times	±10% typical resistance change
Mechanical Shock	MIL-STD-202, Method 213, Condition 1 (100g, 6 seconds)	No resistance change
Solvent Resistance	MIL-STD-202, Method 215	No change
Vibration	MIL-STD-883C, Method 2007.1, Condition A	No change

Test Procedures And Requirements

Test	Test Conditions	Accept/Reject Criteria
Visual/Mech.	Verify dimensions and materials	Per PF physical description
Resistance	In still air @ 23°C	$R_{min} \leq R \leq R_{max}$
Time to Trip	5 times I_{hold} , V_{max} , 23°C	$T \leq \text{max. time to trip (seconds)}$
Hold Current	30 min. at I_{hold}	No trip
Trip Cycle Life	V_{max} , I_{max} , 100 cycles	No arcing or burning
Trip Endurance	V_{max} , 48 hours	No arcing or burning
UL File Number	See above	
CSA File Number	See above	
TÜV File Number	See above	

Specifications are subject to change without notice.

PFRA Technical Data, continued



Electrical Characteristics

Model	V max. Volts	I max. Amps	Ihold	Itrip	Initial Resistance		1 Hour (R ₁) Post-Trip Resistance	Max. Time To Trip at 5*1h	Tripped Power Dissipation
			Amperes at 23°C		Ohms at 23°C		Ohms at 23°C	Seconds at 23°C	Watts at 23°C
			Hold	Trip	Min.	Max.	Max.		
PFRA.010.X	60	40	0.10	0.20	2.50	4.50	7.50	4.0	0.38
PFRA.017.X	60	40	0.17	0.34	2.00	3.20	8.00	3.0	0.48
PFRA.020.X	60	40	0.20	0.40	1.50	2.84	4.40	2.2	0.40
PFRA.025.X	60	40	0.25	0.50	1.00	1.95	3.00	2.5	0.45
PFRA.030.X	60	40	0.30	0.60	0.76	1.36	2.10	3.0	0.50
PFRA.040.X	60	40	0.40	0.80	0.52	0.86	1.29	3.8	0.55
PFRA.050.X	60	40	0.50	1.00	0.41	0.77	1.17	4.0	0.75
PFRA.065.X	60	40	0.65	1.30	0.27	0.48	0.72	5.3	0.90
PFRA.075.X	60	40	0.75	1.50	0.18	0.40	0.60	6.3	0.90
PFRA.090.X	60	40	0.90	1.80	0.14	0.31	0.47	7.2	1.00
PFRA.090.X.009	30	40	0.90	1.80	0.07	0.12	0.22	5.9	0.60
PFRA.110.X	30	40	1.10	2.20	0.10	0.18	0.27	6.6	0.70
PFRA.135.X	30	40	1.35	2.70	0.065	0.115	0.17	7.3	0.80
PFRA.160.X	30	40	1.60	3.20	0.055	0.105	0.15	8.0	0.90
PFRA.185.X	30	40	1.85	3.70	0.04	0.07	0.11	8.7	1.00
PFRA.250.X	30	40	2.50	5.00	0.025	0.048	0.07	10.3	1.20
PFRA.250.X.010	30	40	2.50	5.00	0.025	0.048	0.07	10.3	1.20
PFRA.300.X	30	40	3.00	6.00	0.02	0.05	0.08	10.8	2.00
PFRA.400.X	30	40	4.00	8.00	0.01	0.03	0.05	12.7	2.50
PFRA.500	30	40	5.00	10.00	0.01	0.03	0.05	14.5	3.00
PFRA.600	30	40	6.00	12.00	0.005	0.02	0.04	16.0	3.50
PFRA.700	30	40	7.00	14.00	0.005	0.02	0.03	17.5	3.80
PFRA.800	30	40	8.00	16.00	0.005	0.02	0.03	18.8	4.00
PFRA.900	30	40	9.00	18.00	0.005	0.01	0.02	*20.0	4.20

*Tested at 40 amps

Packaging options

BULK: PFRA.010-PFRA.185 = 500 pcs. per bag; PFRA.250-PFRA.900 = 100 pcs. per bag;
(leave.X space) PFRA.090.X.009 & PFRA.250.X.010 = 500 pcs. per bag.

TAPE & REEL: PFRA.010-PFRA.160 - 12.7mm device pitch = 3000 pcs. per reel;
X=.2 PFRA.185-PFRA.400 - 25.4mm device pitch = 1500 pcs. per reel;
PFRA.090.X.009 & PFR.A250.X.010 = 3000 pcs. per reel.

AMMO-PACK: PFRA.010-PFRA.160 - 12.7mm device pitch = 2000 pcs. per reel;
X=.3 PFRA.185-PFRA.400 - 25.4mm device pitch = 1000 pcs. per reel;
PFRA.090.X.009 & PFRA.250.X.010 = 2000 pcs. per reel.

Product Dimension

Model	A Max.	B Max.	C		D Min.	E Max.	Physical Characteristics		
			Nom.	Tol. ±			Style	Lead	Material
PFRA.010.X	7.4	12.7	5.1	0.7	7.6	3.1	1	0.51 dia.	Sn/NiCu
PFRA.017.X	7.4	12.7	5.1	0.7	7.6	3.1	1	0.51 dia.	Sn/CuFe
PFRA.020.X	7.4	12.7	5.1	0.7	7.6	3.1	1	0.51 dia.	Sn/CuFe
PFRA.025.X	7.4	12.7	5.1	0.7	7.6	3.1	1	0.51 dia.	Sn/CuFe
PFRA.030.X	7.4	13.4	5.1	0.7	7.6	3.1	1	0.51 dia.	Sn/CuFe
PFRA.040.X	7.4	13.7	5.1	0.7	7.6	3.1	1	0.51 dia.	Sn/CuFe
PFRA.050.X	7.9	13.7	5.1	0.7	7.6	3.1	1	0.51 dia.	Sn/Cu
PFRA.065.X	9.7	15.2	5.1	0.7	7.6	3.1	1	0.51 dia.	Sn/Cu
PFRA.075.X	10.4	16.0	5.1	0.7	7.6	3.1	1	0.51 dia.	Sn/Cu
PFRA.090.X	11.7	16.7	5.1	0.7	7.6	3.1	1	0.51 dia.	Sn/Cu
PFRA.090.X.009	7.4	12.2	5.1	0.7	7.6	3.0	2	0.51 dia.	Sn/Cu
PFRA.110.X	8.9	14.0	5.1	0.7	7.6	3.0	1	0.51 dia.	Sn/Cu
PFRA.135.X	8.9	18.9	5.1	0.7	7.6	3.0	1	0.51 dia.	Sn/Cu
PFRA.160.X	10.2	16.8	5.1	0.7	7.6	3.0	1	0.51 dia.	Sn/Cu
PFRA.185.X	12.0	18.4	5.1	0.7	7.6	3.0	1	0.51 dia.	Sn/Cu
PFRA.250.X	12.0	18.3	5.1	0.7	7.6	3.0	2	0.81 dia.	Sn/Cu
PFRA.250.X.010	11.4	18.3	5.1	0.7	7.6	3.0	3	0.51 dia.	Sn/Cu
PFRA.300.X	12.0	18.3	5.1	0.7	7.6	3.0	2	0.81 dia.	Sn/Cu
PFRA.400.X	14.4	24.8	5.1	0.7	7.6	3.0	2	0.81 dia.	Sn/Cu
PFRA.500	17.4	24.9	10.2	0.7	7.6	3.0	2	0.81 dia.	Sn/Cu
PFRA.600	19.3	31.9	10.2	0.7	7.6	3.0	2	0.81 dia.	Sn/Cu
PFRA.700	22.1	29.8	10.2	0.7	7.6	3.0	2	0.81 dia.	Sn/Cu
PFRA.800	24.2	32.9	10.2	0.7	7.6	3.0	2	0.81 dia.	Sn/Cu
PFRA.900	24.2	32.9	10.2	0.7	7.6	3.0	2	0.81 dia.	Sn/Cu

Dimension = mm

Thermal Derating Chart - I_{hold} (Amps)*

Model	Ambient Operating Temperature								
	-40°C	-20°C	0°C	23°C	40°C	50°C	60°C	70°C	85°C
PFRA.010.X	0.16	0.14	0.12	0.10	0.08	0.07	0.06	0.05	0.04
PFRA.017.X	0.26	0.23	0.20	0.17	0.14	0.12	0.11	0.09	0.07
PFRA.020.X	0.31	0.27	0.24	0.20	0.16	0.14	0.13	0.11	0.08
PFRA.025.X	0.39	0.34	0.30	0.25	0.20	0.18	0.16	0.14	0.10
PFRA.030.X	0.47	0.41	0.36	0.30	0.24	0.22	0.19	0.16	0.12
PFRA.040.X	0.62	0.54	0.48	0.40	0.32	0.29	0.25	0.22	0.16
PFRA.050.X	0.78	0.68	0.60	0.50	0.41	0.36	0.32	0.27	0.20
PFRA.065.X	1.01	0.88	0.77	0.65	0.53	0.47	0.41	0.35	0.26
PFRA.075.X	1.16	1.02	0.89	0.75	0.61	0.54	0.47	0.41	0.30
PFRA.090.X	1.40	1.22	1.07	0.90	0.73	0.65	0.57	0.49	0.36
PFRA.090.X.009	1.40	1.22	1.07	0.90	0.73	0.65	0.57	0.49	0.36
PFRA.110.X	1.60	1.43	1.27	1.10	0.91	0.85	0.75	0.67	0.57
PFRA.135.X	1.96	1.76	1.55	1.35	1.12	1.04	0.92	0.82	0.70
PFRA.160.X	2.32	2.08	1.84	1.60	1.33	1.23	1.09	0.98	0.83
PFRA.185.X	2.68	2.41	2.13	1.85	1.54	1.42	1.26	1.13	0.96
PFRA.250.X	3.63	3.25	2.88	2.50	2.08	1.93	1.70	1.53	1.30
PFRA.250.X.010	3.63	3.25	2.88	2.50	2.08	1.93	1.70	1.53	1.30
PFRA.300.X	4.35	3.90	3.45	3.00	2.49	2.31	2.04	1.83	1.56
PFRA.400.X	5.80	5.20	4.60	4.00	3.32	3.08	2.72	2.44	2.08
PFRA.500	7.25	6.50	5.75	5.00	4.15	3.85	3.40	3.05	2.60
PFRA.600	8.70	7.80	6.90	6.00	4.98	4.62	4.08	3.66	3.12
PFRA.700	10.15	9.10	8.05	7.00	5.81	5.39	4.76	4.27	3.64
PFRA.800	11.60	10.40	9.20	8.00	6.64	6.16	5.44	4.88	4.16
PFRA.900	13.05	11.70	10.35	9.00	7.47	6.39	6.12	5.49	4.68

See the following page for tape and reel specifications.

$$*I_{trip} = 2 \cdot I_{hold}$$

How to Order

PF RA . 250 . X

Product Designator ┌

Style _____

RA = Radial Leaded Component

Hold Current, I_{hold} _____

010-900 (100m Amps - 9.0 Amps)

Packaging Options _____

Blank = Bulk Packaging
 .2 = Tape and Reel*
 .3 = Ammo-Pak*

NOTE: Add designator "010" after Packaging Option
 Code to specify Models PFRA090-0-010 or
 PFRA250-0-010.

*Packaged per EIA486-B

Schurter's resettable fuses cross to many like products already on the market.
 See our online cross list at www.schurterinc.com/cross.htm

PFRA Tape and Reel Specifications



Devices taped using EIA468-B/IEC286-2 standards. See table below and Figures 1 and 2 for details.

Dimension Description	IEC Mark	EIA Mark	Dimensions	
			Dim. (mm)	Tol. (mm)
Carrier tape width	<i>W</i>	<i>W</i>	18	-0.5/+1.0
Hold down tape width		<i>W4</i>	5	min.
Hold down tape	<i>W0</i>		No protrusion	
Top distance between tape edges	<i>W2</i>	<i>W6</i>	3	max.
Sprocket hole position	<i>W1</i>	<i>W5</i>	9	-0.5/+0.75
Sprocket hole diameter	<i>D0</i>	<i>D0</i>	4	± 0.2
Abscissa to plane (straight lead)	<i>H</i>	<i>H</i>	18.5	± 3.0
Abscissa to plane (kinked lead)	<i>H0</i>	<i>H0</i>	16	± 0.5
Abscissa to top	<i>H1</i>	<i>H1</i>	32.2	max.
Overall width w/lead protrusion		<i>C1</i>	43.2	max.
Overall width w/o lead protrusion		<i>C2</i>	42.5	max.
Lead protrusion	<i>l1</i>	<i>L1</i>	1.0	max.
Protrusion of cutout	<i>L</i>	<i>L</i>	11	max.
Protrusion beyond hold tape	<i>l2</i>	<i>l2</i>	Not specified	
Sprocket hole pitch	<i>P0</i>	<i>P0</i>	12.7	± 0.3
Pitch tolerance			20 seconds	± 1
Device pitch: PFRA.010 – PFRA.160			12.7	
Device pitch: PFRA.185 – PFRA.400			25.4	
Tape thickness	<i>t</i>	<i>t</i>	0.9	max.
Tape thickness with splice		<i>t1</i>	2.0	max.
Splice sprocket hole alignment			0	± 0.3
Body lateral deviation	Δh	Δh	0	± 1.0
Body tape plane deviation	Δp	Δp	0	± 1.3
Lead seating plane deviation	$\Delta P1$	<i>P1</i>	0	± 0.7
Lead spacing	<i>F</i>	<i>F</i>	5.08	± 0.8
Reel width	<i>w</i>	<i>w</i>	56	max.
Reel diameter	<i>d</i>	<i>a</i>	370	max.
Space between flanges less device			4.75	± 3.25
Arbor hole diameter	<i>f</i>	<i>c</i>	26	± 12.0
Core diameter	<i>h</i>	<i>n</i>	80	max.
Box			56/372/372	max.
Consecutive missing places			3 maximum	
Empty places per reel			Not specified	

Taped Component Dimensions

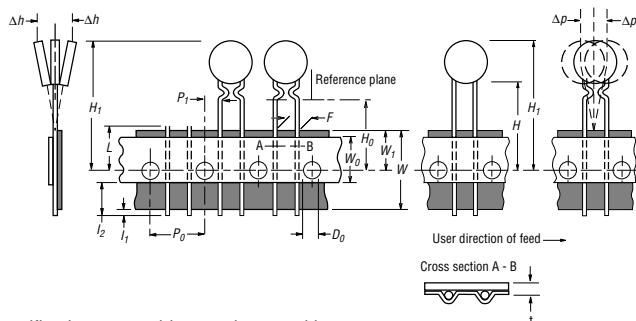

Specifications are subject to change without notice.

Reel Dimensions

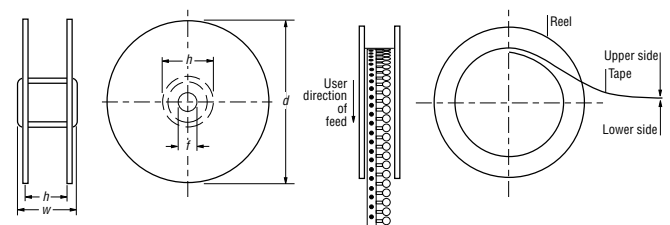

PFRX Polymeric PTC Resettable Fuse - Radial Leaded



Typical Time to Trip at 23°C

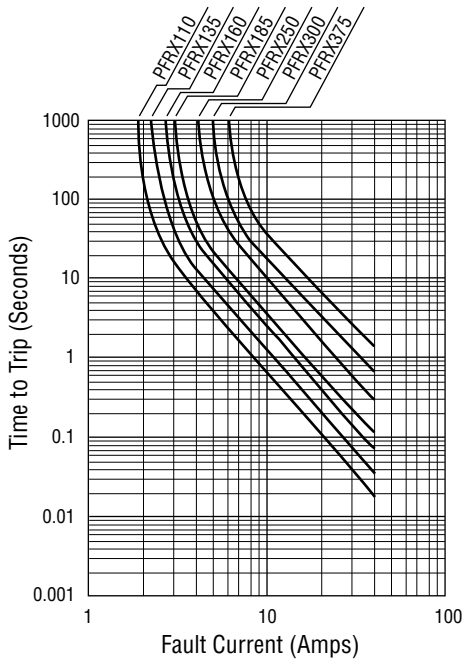

NEW



- Cured, flame retardant epoxy polymer insulating material meets UL 94V-0 requirements
- Bulk packaging, tape and reel and Ammo-Pak available on most models
- Applications: Almost anywhere there is a low voltage power supply, up to 60V and a load to be protected, including: computers & peripherals, general electronics, automotive applications

Approvals:

- UL recognition, file #E172175 (60V)
- CSA acceptance, file #CA702083 (60V)
- TÜV certification, file #R9872200 (60V)

Package 1

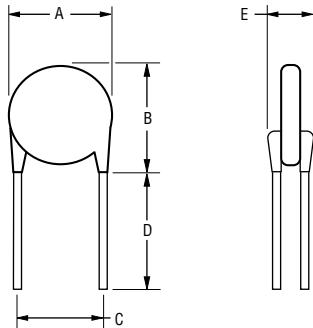

Lead Material
0.81 dia. (20AWG)

NOTE: Kinked lead option is available for board standoff. Contact factory for details.

Typical Part Marking

Represents total content. Layout may vary.

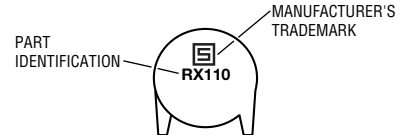

Technical Data

Operating/Storage Temperature	-40°C to +85°C	
Maximum Device Surface Temperature in Tripped State	125°C	
Passive Aging	+85°C, 1000 hours	±5% typical resistance change
Humidity Aging	+85°C, 85% R.H. 1000 hours	±5% typical resistance change
Thermal Shock	+125°C/-40°C 10 times	±10% typical resistance change
Mechanical Shock	MIL-STD-202, Method 213, Condition 1 (100g, 6 seconds)	No resistance change
Solvent Resistance	MIL-STD-202, Method 215	No change
Vibration	MIL-STD-883C, Method 2007.1, Condition A	No change

Test Procedures And Requirements

Test	Test Conditions	Accept/Reject Criteria
Visual/Mech.	Verify dimensions and materials	Per PF physical description
Resistance	In still air @ 23°C	$R_{min} \leq R \leq R_{max}$
Time to Trip	5 times Ihold, Vmax, 23°C	T ≤ max. time to trip (seconds)
Hold Current	30 min. at Ihold	No trip
Trip Cycle Life	Vmax, Imax, 100 cycles	No arcing or burning
Trip Endurance	Vmax, 48 hours	No arcing or burning

PFRX Technical Data, continued



Electrical Characteristics

Model	V max. Volts	I max. Amps	I _{hold}	I _{trip}	Initial Resistance		1 Hour (R ₁) Post-Trip Resistance	Max. Time To Trip at 5*I _h	Tripped Power Dissipation
			Amperes at 23°C		Ohms at 23°C		Ohms at 23°C	Seconds at 23°C	Watts at 23°C
			Hold	Trip	Min.	Max.	Max.		
PFRX.110.X	60	40	1.10	2.20	0.15	0.25	0.38	8.2	1.50
PFRX.135.X	60	40	1.35	2.70	0.12	0.19	0.30	9.6	1.70
PFRX.160.X	60	40	1.60	3.20	0.09	0.14	0.22	11.4	1.90
PFRX.185.X	60	40	1.85	3.70	0.08	0.12	0.19	12.6	2.10
PFRX.250	60	40	2.50	5.00	0.05	0.08	0.13	15.6	2.50
PFRX.300	60	40	3.00	6.00	0.04	0.06	0.10	19.8	2.80
PFRX.375	60	40	3.75	7.50	0.03	0.05	0.08	24.0	3.20

Packaging options:

BULK: All models = 100 pcs. per bag.
(leave .X space empty)

TAPE & REEL: PFRX.110 – PFRX.160 = 1500 pcs. per reel; PFRX.185 = 1000 pcs. per reel
.X = 2

AMMO-PACK: PFRX.110 – PFRX.160 = 1000 pcs. per reel; PFRX.185 = 500 pcs. per reel
.X = 3

Product Dimensions

Model	A	B	C		D	E	Physical Characteristics		
	Max.	Max.	Nom.	Tol. ±	Min.	Max.	Style	Lead	Material
PFRX.110.X	13.0	18.0	5.1	0.7	7.6	3.1	1	0.81 dia.	Sn/Cu
PFRX.135.X	14.5	19.6	5.1	0.7	7.6	3.1	1	0.81 dia.	Sn/Cu
PFRX.160.X	16.3	21.3	5.1	0.7	7.6	3.1	1	0.81 dia.	Sn/Cu
PFRX.185.X	17.8	22.9	5.1	0.7	7.6	3.1	1	0.81 dia.	Sn/Cu
PFRX.250	21.3	26.4	10.2	0.7	7.6	3.1	1	0.81 dia.	Sn/Cu
PFRX.300	24.9	30.0	10.2	0.7	7.6	3.1	1	0.81 dia.	Sn/Cu
PFRX.375	28.4	33.5	10.2	0.7	7.6	3.1	1	0.81 dia.	Sn/Cu

DIMENSIONS = MM

Thermal Derating Chart - I_{hold} (Amps)

Part No.	Ambient Operating Temperature								
	-40°C	-20°C	0°C	23°C	40°C	50°C	60°C	70°C	85°C
PFRX.110.X	1.71	1.50	1.31	1.10	0.89	0.79	0.69	0.59	0.44
PFRX.135.X	2.09	1.84	1.61	1.35	1.09	0.97	0.85	0.73	0.54
PFRX.160.X	2.48	2.18	1.90	1.60	1.30	1.15	1.01	0.86	0.64
PFRX.185.X	2.87	2.52	2.20	1.85	1.50	1.33	1.17	1.00	0.74
PFRX.250	3.88	3.40	2.98	2.50	2.03	1.80	1.58	1.35	1.00
PFRX.300	4.65	4.08	3.57	3.00	2.43	2.16	1.89	1.62	1.20
PFRX.375	5.81	5.10	4.46	3.75	3.04	2.70	2.36	2.03	1.50

How to Order

Product Designator **PF RX . 110 . X**

Style _____

RX = Radial Leaded Component

Hold Current, I_{hold}
110-375 (1.10 Amps - 3.75 Amps)

blank = Bulk Packaging
.2 = Tape and Reel*
.3 = Ammo-Pak*

*Packaged per EIA 486-B

Schurter's resettable fuses cross to many like products already on the market. [See our online cross list at www.schurterinc.com/cross.htm](http://www.schurterinc.com/cross.htm)

PFRX Tape and Reel Specifications



Devices taped using EIA468-B/IEC286-2 standards. See table below and Figures 1 and 2 for details.

Dimension Description	IEC Mark	EIA Mark	Dimensions	
			Dim. (mm)	Tol. (mm)
Carrier tape width	<i>W</i>	<i>W</i>	18	-0.5/+1.0
Hold down tape width		<i>W4</i>	5	min.
Hold down tape	<i>W0</i>		No protrusion	
Top distance between tape edges	<i>W2</i>	<i>W6</i>	3	max.
Sprocket hole position	<i>W1</i>	<i>W5</i>	9	-0.5/+0.75
Sprocket hole diameter	<i>D0</i>	<i>D0</i>	4	± 0.2
Abscissa to plane (straight lead)	<i>H</i>	<i>H</i>	18.5	± 3.0
Abscissa to plane (kinked lead)	<i>H0</i>	<i>H0</i>	16	± 0.5
Abscissa to top	<i>H1</i>	<i>H1</i>	32.2	max.
Overall width w/lead protrusion		<i>C1</i>	43.2	max.
Overall width w/o lead protrusion		<i>C2</i>	42.5	max.
Lead protrusion	<i>I1</i>	<i>L1</i>	1.0	max.
Protrusion of cutout	<i>L</i>	<i>L</i>	11	max.
Protrusion beyond hold tape	<i>I2</i>	<i>I2</i>	Not specified	
Sprocket hole pitch	<i>P0</i>	<i>P0</i>	12.7	± 0.3
Pitch tolerance			20 seconds	± 1
Device pitch: PFRX.110 – PFRX.160			12.7	
Device pitch: PFRX.185 – PFRX.375			25.4	
Tape thickness	<i>t</i>	<i>t</i>	0.9	max.
Tape thickness with splice		<i>t1</i>	2.0	max.
Splice sprocket hole alignment			0	± 0.3
Body lateral deviation	Δh	Δh	0	± 1.0
Body tape plane deviation	Δp	Δp	0	± 1.3
Lead seating plane deviation	$\Delta P1$	<i>P1</i>	0	± 0.7
Lead spacing	<i>F</i>	<i>F</i>	5.08	± 0.8
Reel width	<i>w</i>	<i>w</i>	56	max.
Reel diameter	<i>d</i>	<i>a</i>	370	max.
Space between flanges less device			4.75	± 3.25
Arbor hole diameter	<i>f</i>	<i>c</i>	26	± 12.0
Core diameter	<i>h</i>	<i>n</i>	80	max.
Box			56/372/372	max.
Consecutive missing places			3 maximum	
Empty places per reel			Not specified	

Taped Component Dimensions

Reel Dimensions

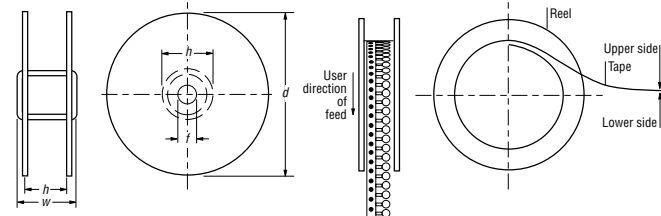
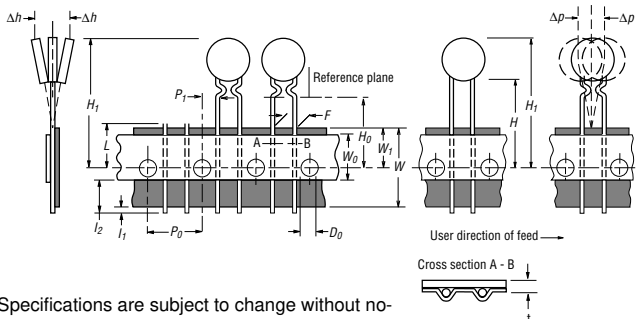

Specifications are subject to change without notice.

PFST Polymeric PTC Resettable Fuse - Strap



Typical Time to Trip at 23°C

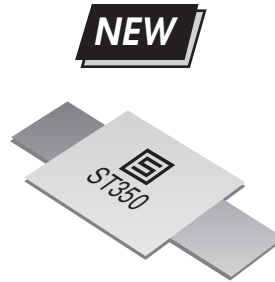
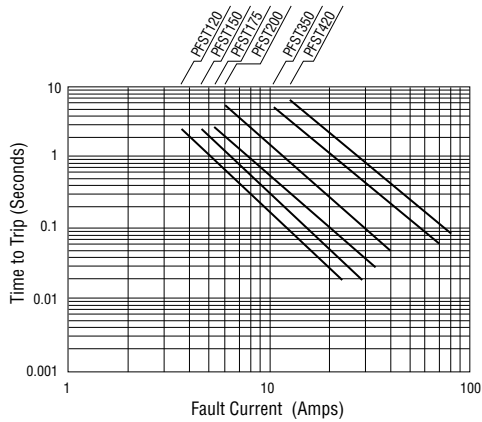

- Fully compatible with current industry standards
- Weldable nickel terminals
- Very low internal resistance
- Applications: Rechargeable Battery Pack Protection

Approvals*:

- UL recognition, file #E172175 (1.2A - 1.75A/15V; 2A - 3.5A/30V)
- CSA acceptance, file #CA702083 (1.2A - 1.75A/15V; 2A - 4.2A/30V)
- TÜV certification, file #R9872200

* rated amps at hold current I_{hold}

Standard Package

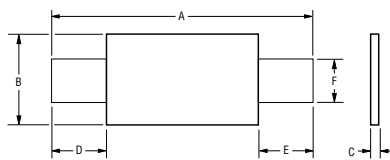

"S" Package

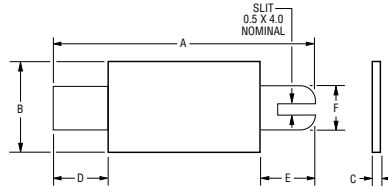

Typical Part Marking

Represents total content. Layout may vary.

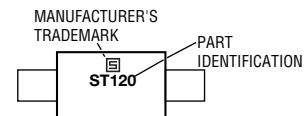

Technical Data

Operating/Storage Temperature	-40°C to +85°C	
Maximum Device Surface Temperature in Tripped State	125°C	
Passive Aging	+85°C, 1000 hours	±5% typical resistance change
Humidity Aging	+85°C, 85% R.H. 1000 hours	±5% typical resistance change
Thermal Shock	+125°C/-40°C 10 times	±10% typical resistance change
Vibration	MIL-STD-883C, Method 2007.1, Condition A	No change

Test Procedures And Requirements

Test	Test Conditions	Accept/Reject Criteria
Visual/Mech.	Verify dimensions and materials	Per PF physical description
Resistance	In still air @ 23°C	$R_{min} \leq R \leq R_{ma}$
Time to Trip	At specified current, max. 23°C	$T \leq \text{max. time to trip (seconds)}$
Hold Current	30 min. at I_{hold}	No trip
Trip Cycle Life	V_{max} , I_{max} , 100 cycles	No arcing or burning
Trip Endurance	V_{max} , 48 hours	No arcing or burning

Product Dimensions

Model	A		B		C		D		F		Material
	Min.	Max.	Min.	Max.	Min.	Max.	Min.	Max.	Min.	Max.	
PFST.120	19.9	22.1	4.9	5.2	0.6	1.0	5.5	7.5	3.9	4.1	Nickel
PFST.120S	19.9	22.1	4.9	5.2	0.6	1.0	5.5	7.5	3.9	4.1	Nickel
PFST.150	21.3	23.4	10.2	11.0	0.5	1.1	4.1	5.5	4.8	5.4	Nickel
PFST.175	20.9	23.1	4.9	5.2	0.6	1.0	4.1	5.5	3.9	4.1	Nickel
PFST.175S	20.9	23.1	4.9	5.2	0.6	1.0	4.1	5.5	3.9	4.1	Nickel
PFST.200	21.3	23.4	10.2	11.0	0.5	1.1	5.0	7.6	4.8	5.4	Nickel
PFST.350	28.4	31.8	13.0	13.5	0.5	1.1	6.3	8.9	6.0	6.6	Nickel
PFST.420	30.6	32.4	12.9	13.6	0.5	1.1	5.0	7.5	6.0	6.7	Nickel

DIMENSIONS = MM

PFST Technical Data, continued



Electrical Characteristics

Model	V max. Volts	I max. Amps	I _{hold}	I _{trip}	Initial Resistance		1 Hour (R ₁) Post-Trip Resistance	Max. Time To Trip at 5*I _h	Tripped Power Dissipation
			Amperes at 23°C		Ohms at 23°C		Ohms at 23°C	Seconds at 23°C	Watts at 23°C
			Hold	Trip	Min.	Max.	Max.		
PFST.120	15	100	1.20	2.7	0.085	0.160	0.22	5.0	1.2
PFST.120S	15	100	1.20	2.7	0.085	0.160	0.22	5.0	1.2
PFST.150	15	100	1.50	3.00	0.05	0.09	0.11	5.0	1.30
PFST.175	15	100	1.75	3.8	0.05	0.09	0.120	4.0	1.5
PFST.175S	15	100	1.75	3.8	0.05	0.09	0.120	4.0	1.5
PFST.200	30	100	2.00	4.4	0.03	0.06	0.080	4.0	1.90
PFST.350	30	100	3.50	6.3	0.017	0.031	0.040	3.0*	2.50
PFST.420	30	100	4.20	7.6	0.012	0.024	0.040	6.0*	2.90

All models packaged loose.

Optional slotted leads (.S) available for 1.20 A and 1.75 A ratings

*Tested at 20.0 Amps

Thermal Derating Chart - I_{hold} (Amps)

Model	Ambient Operating Temperature								
	-40°C	-20°C	0°C	23°C	40°C	50°C	60°C	70°C	85°C
PFST.120	1.9	1.7	1.5	1.2	1.0	0.9	0.8	0.7	0.5
PFST.120S	1.9	1.7	1.5	1.2	1.0	0.9	0.8	0.7	0.5
PFST.150	2.2	2.0	1.8	1.5	1.3	1.1	1.0	0.9	0.7
PFST.175	2.5	2.3	2.0	1.7	1.5	1.3	1.2	1.1	0.9
PFST.175S	2.5	2.3	2.0	1.7	1.5	1.3	1.2	1.1	0.9
PFST.200	3.2	2.8	2.5	2.0	1.7	1.6	1.4	1.2	0.9
PFST.350	5.4	4.8	4.3	3.5	3.0	2.8	2.5	2.2	1.7
PFST.420	6.4	5.7	5.1	4.2	3.6	3.3	3.0	2.6	2.1

How To Order

PF ST.120 .S

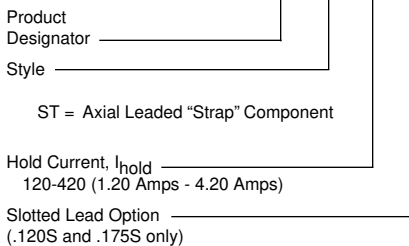

Schurter's resettable fuses cross to many like products already on the market.

See our online cross list at www.schurterinc.com/cross.htm

PFLT Polymeric PTC Resettable Fuse - Axial Leded



Typical Time to Trip at 23°C

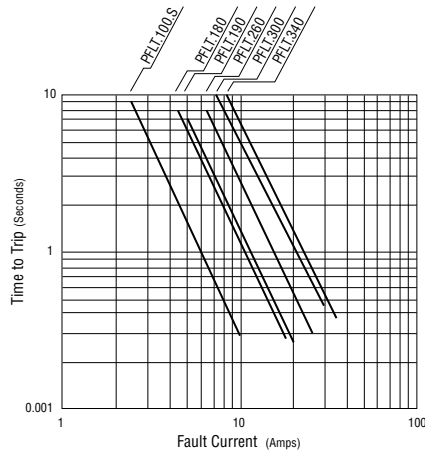

NEW

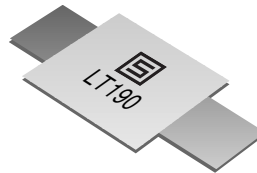

- Fully compatible with current industry standards
- Weldable nickel terminals
- Very low internal resistance
- Applications: Any application that requires extra protection at elevated ambient temperatures, which the 100°C trip temperature provides, including rechargeable battery pack protection, cellular phones, laptop computers

Approvals:

UL recognition, file #E172175
 CSA acceptance, file #CA702083
 TÜV certification, file #R9872200

PFLT models offer trip temperatures lower than PFST models for extra protection at elevated temperatures.

Standard Package

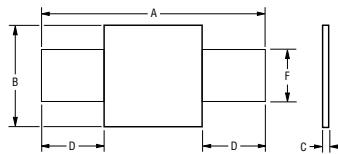

"S" Package

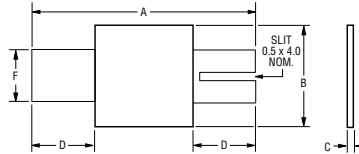

Typical Part Marking

Represents total content. Layout may vary.

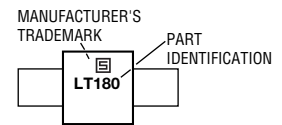

Technical Data

Operating/Storage Temperature	-40°C to +85°C	
Maximum Device Surface Temperature in Tripped State	125°C	
Passive Aging	+85°C, 1000 hours	±5% typical resistance change
Humidity Aging	+85°C, 85% R.H. 1000 hours	±5% typical resistance change
Thermal Shock	+125°C/-40°C 10 times	±10% typical resistance change
Vibration	MIL-STD-883C, Method 2007.1, Condition A	

Test Procedures And Requirements

Test	Test Conditions	Accept/Reject Criteria
Visual/Mech.	Verify dimensions and materials	Per PF physical description
Resistance	In still air @ 23°C	$R_{min} \leq R \leq R_{max}$
Time to Trip	At specified current, 23°C	$T \leq \text{max. time to trip (seconds)}$
Hold Current	30 min. at Ihold	No trip
Trip Cycle Life	Vmax, Imax, 100 cycles	No arcing or burning
Trip Endurance	Vmax, 48 hours	No arcing or burning

Product Dimensions

Model	A		B		C		D		F		Package Style
	Min.	Max.	Min.	Max.	Min.	Max.	Min.	Max.	Min.	Max.	
PFLT.100.S	20.9	23.1	4.9	5.2	0.6	1.0	4.1	5.5	3.9	4.1	S
PFLT.180	24.0	26.0	4.9	5.2	0.6	1.0	4.1	5.5	3.9	4.1	Std.
PFLT.180.S	24.0	26.0	4.9	5.2	0.6	1.0	4.1	5.5	3.9	4.1	S
PFLT.190	21.3	23.4	10.2	11.0	0.5	1.1	5.0	7.6	4.8	5.4	Std.
PFLT.260	24.0	26.0	10.8	11.9	0.6	1.0	5.0	7.0	5.9	6.1	Std.
PFLT.300	28.4	31.8	13.0	13.5	0.5	1.1	6.3	8.9	6.0	6.6	Std.
PFLT.340	24.0	26.0	14.8	15.9	0.6	1.0	4.0	5.0	5.9	6.1	Std.

DIMENSIONS = MM

Electrical Characteristics

Model	V max. Volts	I max. Amps	I_{hold}	I_{trip}	Initial Resistance		1 Hour (R_1) Post-Trip Resistance	Max. Time To Trip at $5 \cdot I_h$	Tripped Power Dissipation
			Amperes at 23°C		Ohms at 23°C		Ohms at 23°C	Seconds at 23°C	Watts at 23°C
			Hold	Trip	Min.	Max.	Max.		
PFLT.100.S	24	100	1.0	2.5	0.070	0.130	0.260	7.0	1.5
PFLT.180	24	100	1.8	3.8	0.040	0.068	0.120	2.9	2.0
PFLT.180.S	24	100	1.8	3.8	0.040	0.068	0.120	2.9	2.0
PFLT.190	24	100	1.9	4.2	0.030	0.057	0.100	3.0	1.9
PFLT.260	24	100	2.6	5.2	0.025	0.042	0.076	5.0	2.3
PFLT.300	24	100	3.0	6.3	0.015	0.031	0.055	4.0	2.0
PFLT.340	24	100	3.4	6.8	0.016	0.027	0.050	5.0	2.7

All models packaged loose. Optional slotted leads (.S) available for 1A and 1.8A ratings.

 Thermal Derating Chart - I_{hold} (Amps)

Model	Ambient Operating Temperature								
	-40°C	-20°C	0°C	23°C	40°C	50°C	60°C	70°C	85°C
PFLT.100.S	1.8	1.6	1.4	1.0	0.8	0.7	0.6	0.4	0.2
PFLT.180	3.1	2.6	2.2	1.8	1.3	1.1	0.9	0.6	0.2
PFLT.180.S	3.1	2.6	2.2	1.8	1.3	1.1	0.9	0.6	0.2
PFLT.190	3.3	2.8	2.4	1.9	1.4	1.2	1.1	0.7	0.4
PFLT.260	4.3	3.7	3.1	2.6	1.9	1.6	1.4	1.1	0.6
PFLT.300	5.1	4.4	3.7	3.0	2.3	1.9	1.6	1.2	0.6
PFLT.340	5.5	4.7	4.0	3.4	2.6	2.2	1.9	1.5	0.8

How To Order

PF LT . 100 . S

Product Designator _____
 Style _____
 LT = Low Temperature Axial Leaded "Strap" Component
 Hold Current, I_{hold} _____
 100-340 (1.00 Amps - 3.40 Amps)
 Slotted Lead Option _____
 (100.s and 180.s only)

Schurter's resettable fuses cross to many like products already on the market.

See our online cross list at www.schurterinc.com/cross.htm

About Non-Resettable Fuses

How to Specify Fuses:

The safety of electronic and electric equipment not only depends upon the use of shock-safe primary circuit components (fuseholders, voltage selector switches, power entry modules, etc.) designed primarily for the protection of service personnel, but also on devices protecting the safe operation of the equipment itself. Since in many cases fuses are the only means of providing circuit protection in the event of overloads or fault conditions, we suggest the following considerations be observed when fuses are being selected.

1. Fuse Standards

There are three principal standards a fuse can be designed to:
 1) UL 248-14 2) CSA 22.2 No. 59 3) IEC 127

Please note that these standards may not necessarily be compatible with each other. The main difference between the various standards are as follows:

- different blowing characteristics between UL/CSA and IEC standards
- different temperature rise requirements between UL and CSA standards

The incompatibility of these standards makes it impossible to use one and the same fuse across the world in a given application. Attention needs to be given to the fact that the governing Standard in Europe is IEC. Observation of this fact in the early design stage will save trouble and confusion during the agency approval process. Note: new fuse qualifications have been established for low-voltage fuses; reference EIA/IS-722.

2. Approval Agencies

National approval agencies which approve miniature type fuses conforming to either UL, CSA, or IEC standards are: UL (USA), CSA (Canada), VDE (Germany), SEMKO (Sweden), BSI (United

Kingdom). It is important to understand that UL and CSA not only write standards but also issue conformance approvals. IEC, however, limits itself to writing the standards. Conformance with these IEC standards is tested by VDE, SEMKO, and BSI.

A UL approved fuse will either bear the listing or the recognized mark. A listed fuse meets all the requirements of fuse Standard UL 248-14. A fuse with the recognition mark is tested under the Component Program of UL to the fuse manufacturer's own specifications.

CSA now has an equivalent to the Recognized Component Program of UL: CSA Component Acceptance . As far as fuse size is concerned, UL and CSA accept a wide range of dimensions (including the 5 x 20mm size, notably with UL/CSA blowing characteristics!) IEC has standardized around the 5 x 20mm size (notably with IEC blowing characteristics!). The only other size in IEC's document is the 1/4 x 1 1/4" fuse (only in quick acting, low breaking capacity configuration).

Because of overlapping dimensions between the various standards, caution has to be used when trying to categorize or identify a 5 x 20mm or 1/4 x 1 1/4" fuses. The chart below summarizes the aforementioned.

IMPORTANT: All CENELEC (European Committee for Electronic Standards) countries, including EC and EFTA nations, require a high-breaking capacity fuse-link, if the short circuit current through the fuse-link is more than 35A or $10 \times I_n$, whichever is greater, effective January 1st, 1993. Please refer to [Series SP \(pg. 145\)](#) and [SPT \(pg. 148\)](#).

3. Rated Current

The rated current of the fuse should be in accordance with the operating current of the equipment to be protected. Consideration

Fuse Standards and Approvals Around The World

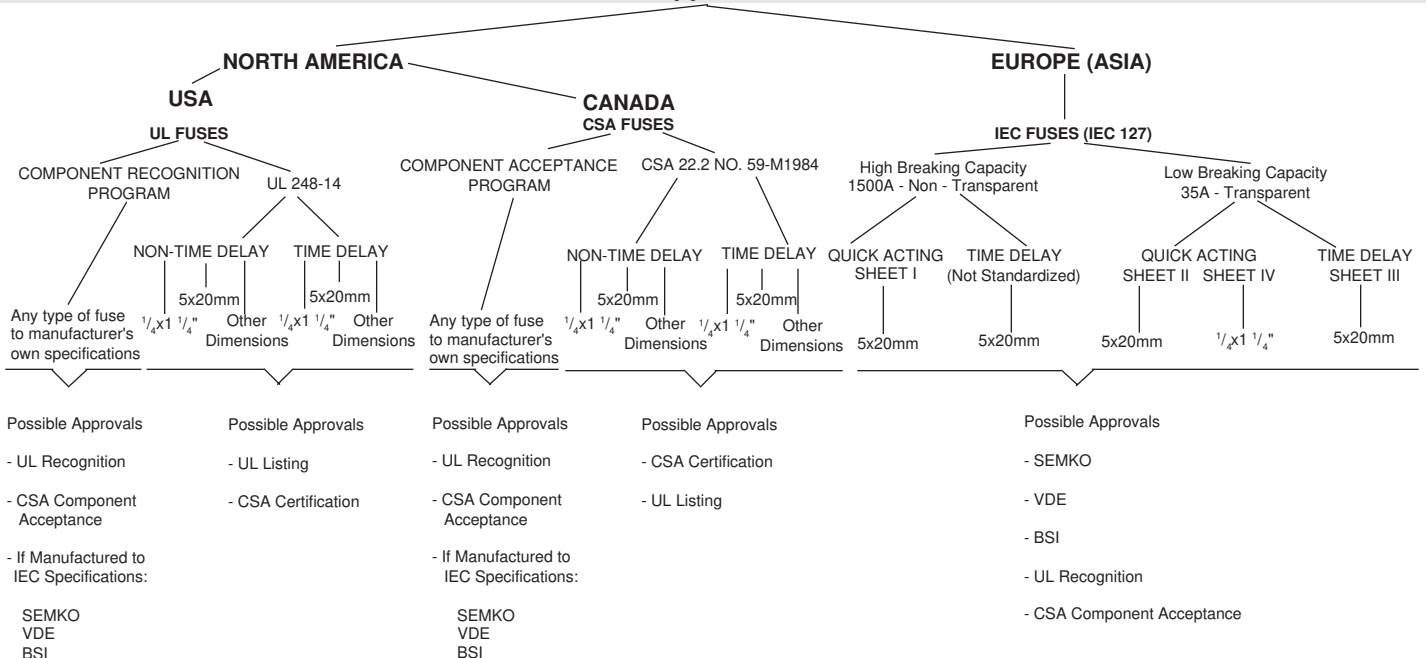

About Non-Resettable Fuses, continued

needs to be given to the fact that the current carrying capacity of a fuse is affected by changes in ambient temperature. IEC and UL/CSA tests are performed at 23°C and 25°C respectively. In practical applications the fuse's ambient temperature may be significantly higher, especially if the fuse is used in an enclosed type fuseholder or mounted near other heat generating components. The effect of changes in the ambient temperature is shown in the chart below.

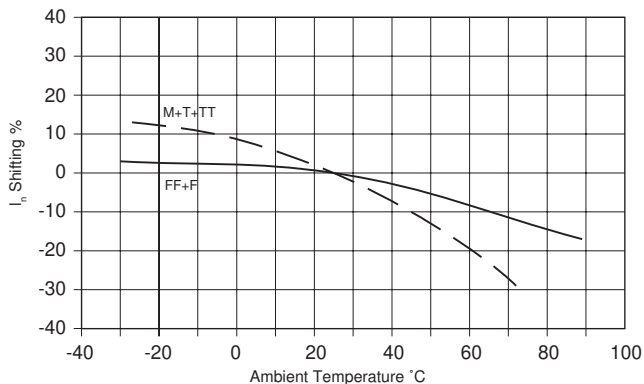

In addition to the effect of ambient temperature conditions, it is recommended to also de-rate UL listed fuses by approximately 25% of the original current ratios. This is, however, not required for IEC fuses (See Para. 10).

4. Rated Voltage

The rated voltage of the fuse should be in no case lower than the operating voltage. At low operating voltage, the inherent resistance must be considered.

Please note that UL and CSA require the use of 250V rated fuses in Power Entry Modules.

5. Breaking Capacity/Short Circuit Rating

The breaking capacity is the short-circuit current which the fuse can break at the rated voltage under the advanced conditions without being destroyed or causing permanent arcing.

Under IEC, miniature type fuses are classified into two categories:

Fuses with Low Breaking Capacity

Typically, the fuse-element of a fuse with low breaking capacity is visible. The insulation tube consists of transparent material, normally glass. There is no extinguishing medium, the arc is quenched in air. The breaking capacity at 250 V and a power factor of 1 is 35 A.

Fuses with High Breaking Capacity

The fuse-element of a fuse with high breaking capacity is not visible. The insulation tube normally is of ceramic material or glass. To quench the arc, there is always an extinguishing medium. The breaking capacity at 250 V and a power factor of .7 to .8 is 1500 A.

UL's and CSA's short circuit requirements are similar, but different as relates to IEC. At 125 V a UL listed fuse has to interrupt 10,000 Amps AC, whereas at 250 V the range may vary from 35 Amps up to 1500 Amps depending on the specific current rating of the fuse.

6. Breaking Characteristic

The breaking characteristic is shown in the respective time-current blowing charts for each fuse type. The breaking characteristic is the melting time of a fuse given a defined load. The melting time is a function of the fuse wire length and diameter as well as its base material and alloy.

IEC fuses are classified as follows:

Quick-Acting Fuses

Application: Protection of semiconductors and for very sensitive instruments. This fuse type tolerates small overcurrents for a short period of time but breaks very quickly at higher current values. It limits short circuit currents at a very early stage.

Time-Lag Fuses

Application: Protection of devices subjected to moderate to high in-rush currents and/or overcurrent peaks, such as transformers and motors. This type of fuse also tolerates higher overcurrents during a short period of time.

UL/CSA fuses are divided into:

Non Time Delay Fuses

These fuses are sometimes also referred to as Normal Blow types.

Time Delay Fuses

These fuses are sometimes also referred to as Slow Blow or Surge Proof types.

For certain applications neither of the above described types may prove usable. Since the writing of Standards by IEC/UL/CSA does not always keep pace with the latest technological advances various fuse manufacturers have developed fuses outside the realm of such standards.

Generally the agencies allow the use of such fuses if a particular application dictates it. The OEM's risks are that it has to rely on manufacturer's own specifications that are not routinely checked by a safety agency. Schurter offers the following use types for such purposes:

Super Quick-Acting Fuses

Application: Protection of semiconductors at the base of S1 and GE (thyristors, triacs, diodes). This fuse type tolerates small overcurrents only during a short period of time and limits the current at small short-circuit currents.

Medium Time-Lag Fuses

Applications: Protection devices subjected to moderate to high in-rush currents and/or overcurrent peaks, such as transformers and motors. This fuse type also tolerates higher overcurrents during a short period of time. Due to its conformance with DIN Standard 41571, this fuse is widely used in Germany; mainly in government related applications.

Super Time-Lag Fuses

Application: Protection of devices subjected to longer lasting in-rush currents and/or high overcurrent peaks like transformers and motors. This type tolerates higher overcurrents during a longer period of time.

About Non-Resettable Fuses, continued

7. Blowing Charts and Tables

This catalog differentiates between two types of blowing charts and tables: IEC and UL/CSA. Proper understanding of these differences is essential when one tries to match the fuse characteristics to the circuit requirements.

a) Chart and Table for IEC fuses: This chart is an interval graph showing a curve representing the minimum blowing times and another curve representing maximum values for a set of current ratings. The tables give the checkpoints or "gates" mandated by IEC. Please note that only the gate values are tested by the agencies. Values on the curve between two gates are geometrically arrived at and are not guaranteed by the manufacturer.

b) Chart and Table for UL/CSA listed fuses: The curves for this graph represent average values, individually for each current rating.

8. Fusing Integral I^2t

The fusing integral is the thermal energy needed to melt the fuse-element. The fusing integral I^2t is used to determine:

- the blowing time for higher overcurrents
- the aging behavior of a fuse caused by in-rush currents.

The formula given below is only valid for blowing periods of less than 10 ms.

$$t = \frac{I^2t}{(\text{overcurrent})^2} = \text{seconds} + 20\%$$

To prevent aging caused by in-rush currents we recommend staying within the following limits:

I^2t of in-rush (to be determined by user)	less than 30% of fuse I^2t for time delay fuses
	less than 40% of fuse I^2t for normal blow fuses

The proper selection of a fuse requires that attention be given to this subject. Often times a fuse problem can only be pinpointed after a thorough study of this issue.

9. Power Dissipation

Power dissipation heats up the fuse and its surroundings. Especially when selecting fuseholders, it is important to ensure that, allowing for the ambient temperature, they are capable of absorbing sufficient dissipated power. Please refer to the power dissipation sections on the individual fuse pages when selecting a fuse.

10. Specification of Characteristics

To quickly and easily classify the various fuse types by their time-current characteristics, the following letter codes are stamped on IEC, or other 5 x 20mm fuses.

	=	Letter Code
super quick-acting	=	FF
quick-acting	=	F
medium time-lag	=	M

time-lag	=	T
super time-lag	=	TT

Example of fuse markings: T200 mA / 250 V

UL listed and CSA certified fuses are not as easily identifiable because neither any lettering nor color code is required on the fuse itself.

11. Dimensions

Traditionally the dimensions have been 5 x 20mm for international type fuses and 1/4 x 1 1/4" (6.3 x 32mm) for domestic, Northern American fuses. Today however, IEC 5 x 20mm fuses with UL recognition and CSA Component Acceptance are becoming increasingly popular in North America, especially in applications where saving space is a major concern.

It should also be pointed out that the 5 x 20mm fuse is available at most over-the-counter distributors as well as radio supply shops in North America.

IEC fuses of the 1/4 x 1 1/4" size should not be used in North America. These fuses were designed for replacement use in American made equipment located in Europe.

12. Interchangeability of IEC Fuses with UL Fuses and Vice Versa

For general applications the rated current of the fuse to be converted should be multiplied/divided by a factor 2 depending on whether the fuse has to be converted from the use in a 250V circuit to the use in a 125V circuit or vice versa. In this case, however, the fuse normally doesn't provide anything more than short current protection. For a more accurate correlation, the time current characteristic curves of both the IEC and UL fuse must be compared. As a rule of thumb, a factor of 2.4 to 2.6 can be used to convert an IEC fuse (used in a 250V circuit) into a UL fuse (used in a 125V circuit) with the corresponding characteristics (e.g. a 1 A IEC fuse corresponds to a 2.5 A UL fuse).

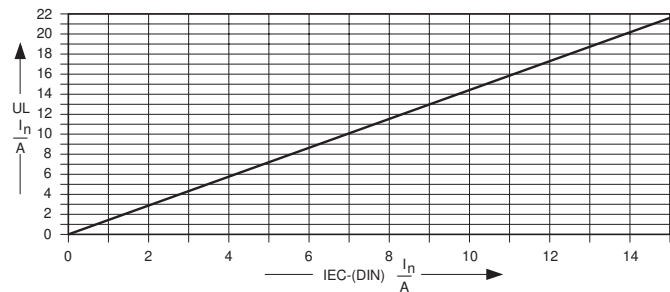

13. Quality Control

Details about Schurter's strict quality control procedures are available upon request.

Should you need fuses for non-standard applications, please contact our Engineering Department.

Note: new fuse qualifications have been established for low-voltage fuses; reference EIA/IS-722.

MGA 125V 125V Quick-acting Surface Mount Fuse



Built according to EIASOCM-3216 (equivalent to 1206), meets EIA/IS-722 fuse qualification standard.

Approvals:

UL recognition 200mA-3A¹⁾ File #E153466
 CSA acceptance 200mA-3A¹⁾ File #LR51172
¹⁾ 4A-5A approvals pending

NEW

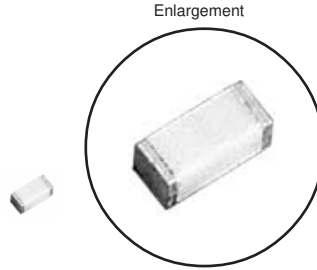
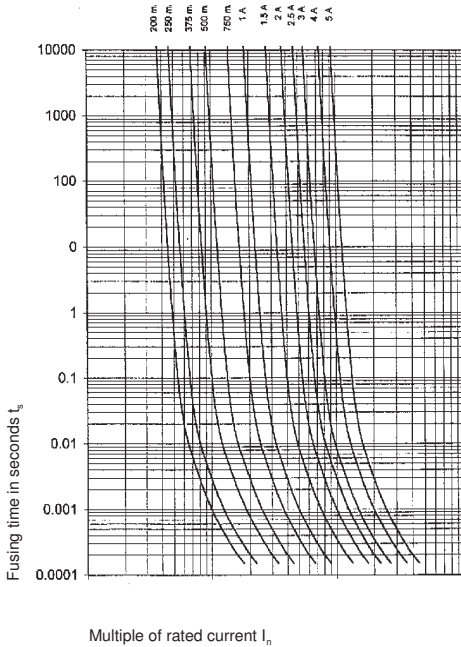

- "Flip chip" design mounts on any side
- Lowest resistance
- Quick-acting
- Hermetically sealed for operating temperatures in excess of 150°C
- Low energy let-through
- Superior cycling

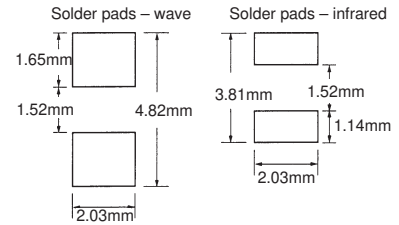
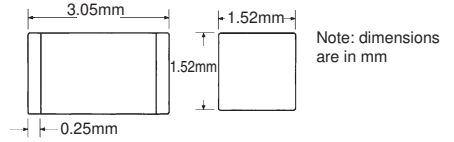

Reel diameter: 179mm (750 pieces & 3,000 pieces)

Time Current Characteristics

rated current I_n	$n \cdot I_n$	I_n	$2.5 \cdot I_n$
		$\geq 4 \text{ h}$	$\leq 5 \text{ s}$
200mA – 5A			

Technical Data

Rated current	see chart
Time current characteristic	quick-acting
Interrupt capacity	50 A AC, 300A DC
Ambient temperature max.	+150°C
Climatic category	hermetically sealed
Solderability	reflow: 260°C / 30 sec. max; wave: 260°C / 10 sec. max.
Soldering heat resistance	60 seconds above 200°C, max. 260°C
Material: Housing	ceramic
Terminals	nickel, tin-lead coated
Packaging	8mm tape and reel per EIA-RS481 (equivalent to IEC 286-3)

Order Numbers – Standard	Rated current / voltage mA / A / V ~	Breaking capacity A ~ ac / dc	Voltage drop at I_n typical mV	Resistance at 10% I_n Ohms	Fusing Integral typ. $A^2 \cdot s$	Packaging Order No. Suffix
Series MGA 125V						
3410.0021.XX	200 mA / 125V	50 A ac / 300A dc	212	0.870	0.0013	100 pieces taped & bagged: .XX = .01
3410.0022.XX*	250 mA / 125V		176	0.632	0.0027	
3410.0025.XX	375 mA / 125V		140	0.320	0.0039	
3410.0027.XX	500 mA / 125V		126	0.198	0.0066	750 pieces taped & reeled: .XX = .02
3410.0029.XX	750 mA / 125V		118	0.113	0.015	
3410.0031.XX	1 A / 125V		135	0.096	0.0042	
3410.0033.XX	1.5 A / 125V		123	0.056	0.12	3,000 pieces taped & reeled: .XX = .03
3410.0035.XX	2 A / 125V		117	0.039	0.20	
3410.0036.XX	2.5 A / 125V		115	0.0295	0.35	
3410.0037.XX	3 A / 125V		112	0.0235	0.55	10,000 pieces taped & reeled: .XX = .04
3410.0140.XX	4 A / 32V†	110	0.0163	0.85		
3410.0141.XX	5 A / 32V†	108	0.0125	1.0		

All ratings measured at 125V, ambient temperature 25°C +/-3°C

* meets UL 1459/1950
 † 4A/63V = 3410.0240.XX
 6A/63V = 3410.0241.XX

MGA Tape and Reel Specifications

Tape Dimension Identifiers	MGA per EIA 481-1
W	8 ± 0.3
P_0	4.0 ± 0.10
P_1	4.0 ± 0.10
P_2	2.0 ± 0.05
A_0	1.91 ± 0.1
B_0	3.56 ± 0.1
B_1 max.	4.35
D_0	$1.5 + 0.1/ -0$
F	3.5 ± 0.05
E_1	1.75 ± 0.10
E_2 min.	6.25
T max.	0.6
T_1 max.	0.1
K_0	1.65 ± 0.1
Leader min.	390
Trailer min.	160
Reel Dimension Identifiers	
A max.	330
N min.	50
W_1	$8.4 + 1.5/ -0$
W_2 max.	14.4

DIMENSIONS: MM

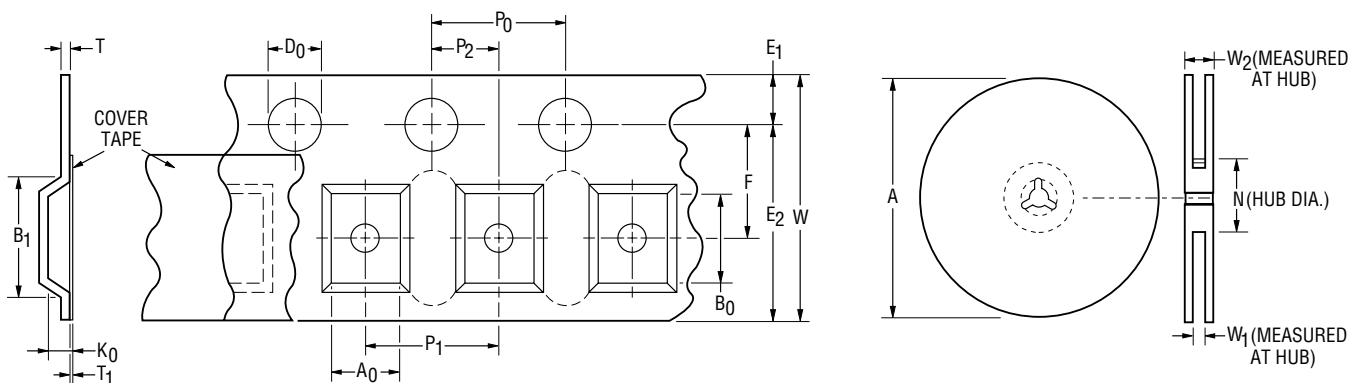

Specifications are subject to change without notice.