



Chipsmall Limited consists of a professional team with an average of over 10 year of expertise in the distribution of electronic components. Based in Hongkong, we have already established firm and mutual-benefit business relationships with customers from,Europe,America and south Asia,supplying obsolete and hard-to-find components to meet their specific needs.

With the principle of “Quality Parts,Customers Priority,Honest Operation,and Considerate Service”,our business mainly focus on the distribution of electronic components. Line cards we deal with include Microchip,ALPS,ROHM,Xilinx,Pulse,ON,Everlight and Freescale. Main products comprise IC,Modules,Potentiometer,IC Socket,Relay,Connector.Our parts cover such applications as commercial,industrial, and automotives areas.

We are looking forward to setting up business relationship with you and hope to provide you with the best service and solution. Let us make a better world for our industry!



Contact us

Tel: +86-755-8981 8866 Fax: +86-755-8427 6832

Email & Skype: info@chipsmall.com Web: www.chipsmall.com

Address: A1208, Overseas Decoration Building, #122 Zhenhua RD., Futian, Shenzhen, China



Surface Mount Multi-Functional DIP Switch IR Solderable, PCB Washable

Features

Optimized Mechanical Features

- Coplanarity: 0.1mm / .004" max.
- Compatible with SMT assembly including IR and Vapor-Phase (up to 260°C)
- Enclosed actuators shield contacts from foreign particles throughout life of switch
- Gull-wing terminal configurations
- Available with SPST, SPDT, DPST, 3PST circuitry choices

Optimized Contact System

- Contact wiping action on make and break
- Integral terminal and contact locked into thermoset base
- Available with low profile, standard, or extended actuators
- Electrostatic discharge shield rated to 22 KV

Materials

- Gold plated contacts for long-term contact corrosion resistance
- All UL 94 V-0 plastics used
- RoHS compliant
- Optional top tape seal for board spray washing

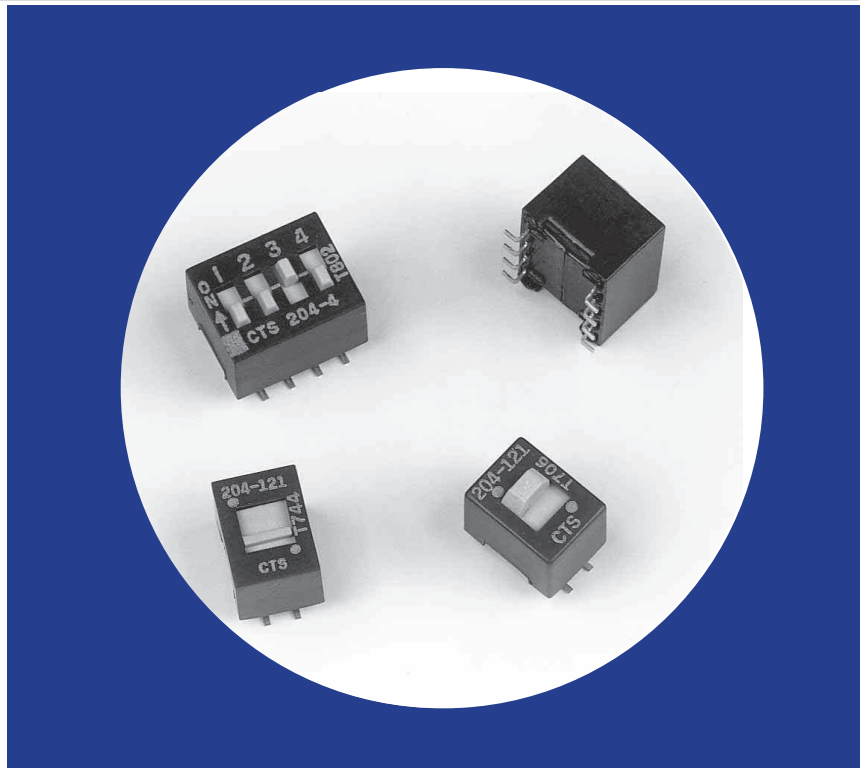

Electrical and Mechanical Specifications

Switch Function

- SPST - 2 through 10 and 12 positions
- SPDT & DPST - 1 through 6 positions
- 3PST - 1 through 4 positions

Contact Resistance

- 50 milliohms maximum initial
- 100 milliohms maximum at end of life

Insulation Resistance

- 1,000 megohms minimum between insulated terminals

Dielectric Strength

- 500 VAC for 1 minute between adjacent switches

Nonswitching Rating

- 100 mA or 50 VDC maximum

Switch Capacitance

- 5 pF maximum between adjacent closed switches

Operating Temperature

- 55°C to +85°C

Actuation Life

- 5,000 cycles switching 50 mA @ 24 VDC

Coplanarity

- 0.1mm/.004" max.

Allowable Solder Time

- Up to 60 seconds at 260°C

Vibration

- Per MIL-STD-202F, method 204D, condition B (.06" or 15 G's between 10 Hz to 2K Hz) with no contact inconsistencies greater than 1 microsecond

Shock

- Per MIL-STD-202F, method 213B, condition A (50 G's) with no contact inconsistencies greater than 1 microsecond

Sealing

- Bottom epoxy seal optional
- Optional top tape seal for board spray washing

Marking

- Special side or top marking available - consult CTS

Packaging

- Standard : Anti-static tube packaging
- Optional : Tape and reel packaging

SPST

SCHEMATIC



Ordering Information SPST Switches

"A" Overall Dimension	No. of Switch Positions	Part No.
7.26 / .286	2	204-2
9.80 / .386	3	204-3
12.34 / .486	4	204-4
14.88 / .586	5	204-5
17.42 / .686	6	204-6
19.96 / .786	7	204-7
22.50 / .886	8	204-8
25.04 / .986	9	204-9
27.58 / 1.086	10	204-10
32.66 / 1.286	12	204-12

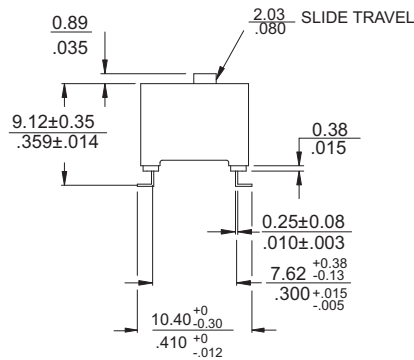
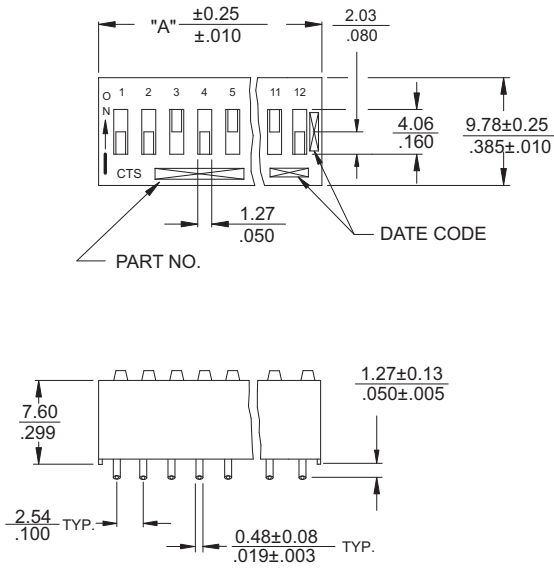

DIMENSION: $\frac{\text{mm}}{\text{inch}}$

SPDT / DPST

Ordering Information SPDT/DPST Switches

"A" Overall Dimension	Number of Switch Positions	Actuation	Part No.
7.26 / .286	1	SPDT/DPST	204-121/204-211
12.34 / .486	2	SPDT/DPST	204-122/204-212
17.42 / .686	3	SPDT/DPST	204-123/204-213
22.50 / .886	4	SPDT/DPST	204-124/204-214
27.58 / 1.086	5	SPDT/DPST	204-125/204-215
32.66 / 1.286	6	SPDT/DPST	204-126/204-216

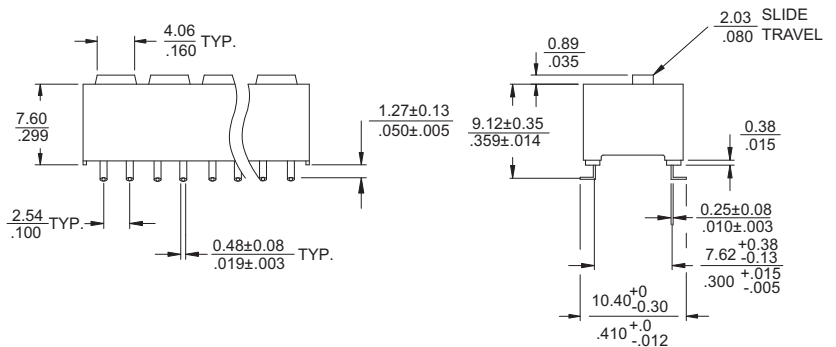
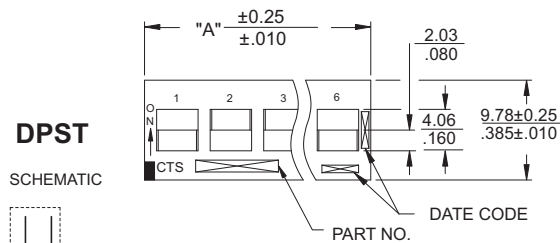
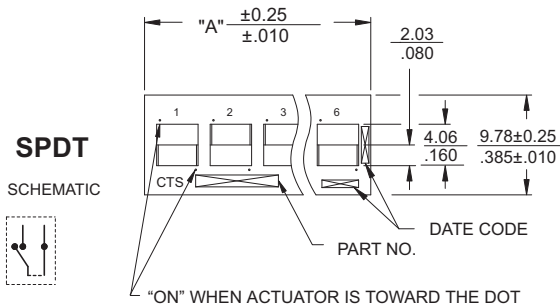

DIMENSION: $\frac{\text{mm}}{\text{inch}}$

3PST

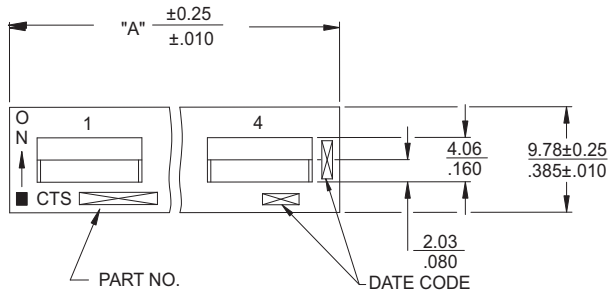

SCHEMATIC



Ordering Information 3PST Switches

"A" Overall Dimension	No. of Switch Positions	Actuation	Part No.
9.80 / .386	1	3PST	204-311
17.42 / .686	2	3PST	204-312
25.04 / .986	3	3PST	204-313
32.66 / 1.286	4	3PST	204-314

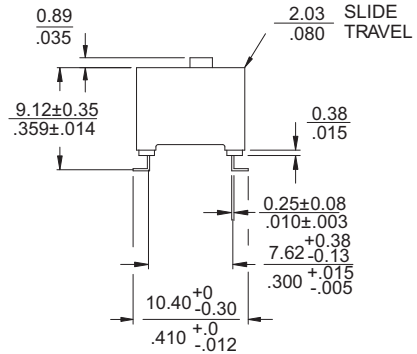
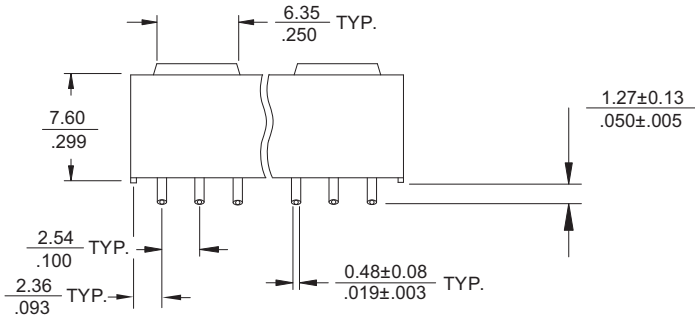

DIMENSION: $\frac{\text{mm}}{\text{inch}}$

Low Profile Actuators (Available in SPST and SPDT)

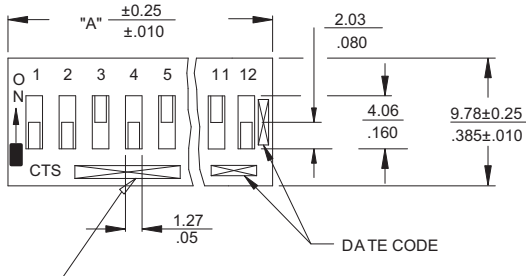

SURFACE MOUNT PAD LAYOUTS (ALL STYLES)

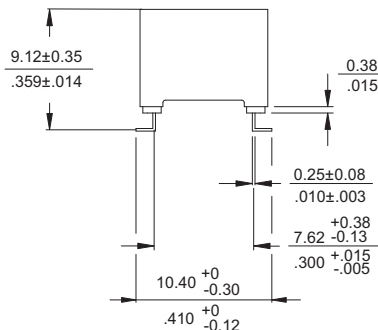
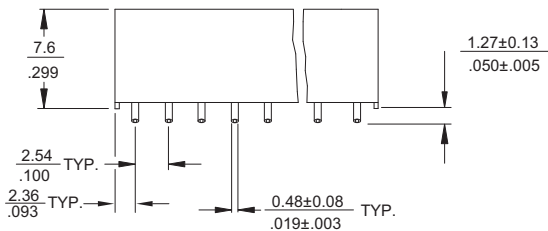
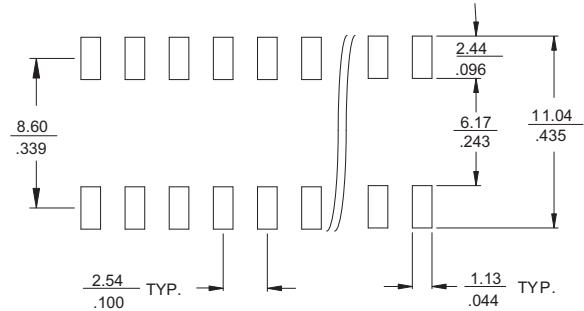

DIMENSION: $\frac{\text{mm}}{\text{inch}}$

Ordering Information

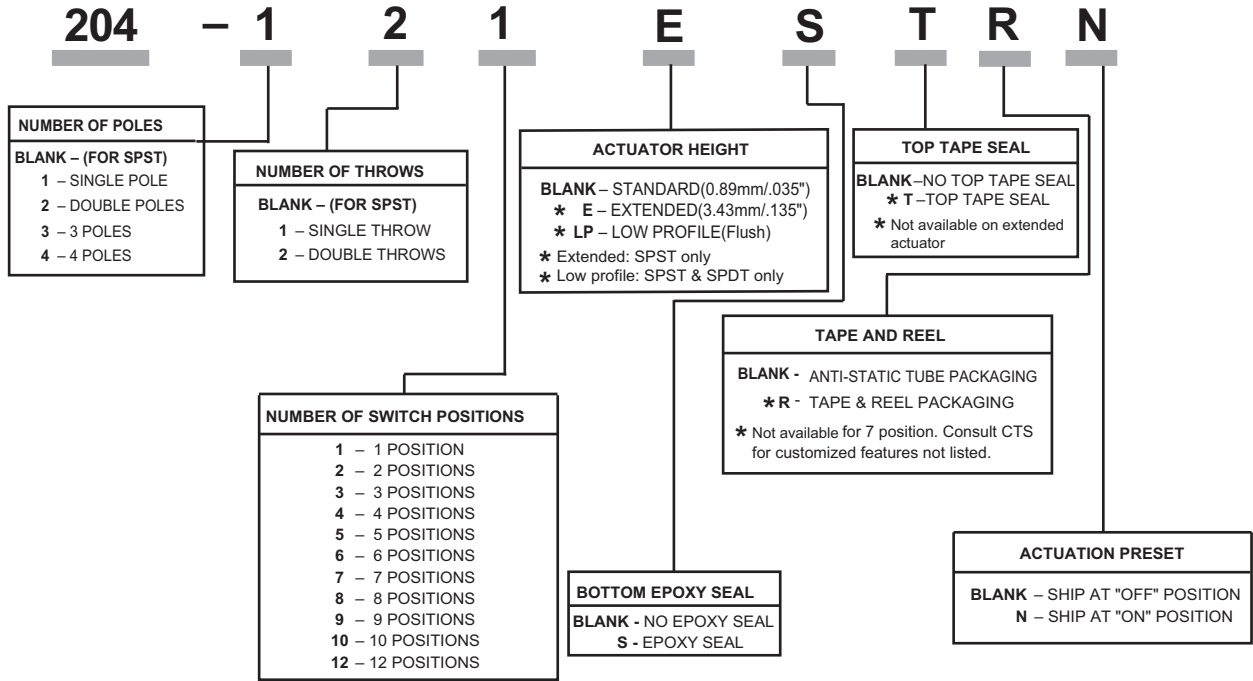

Contact CTS for other common features not listed.