



Chipsmall Limited consists of a professional team with an average of over 10 year of expertise in the distribution of electronic components. Based in Hongkong, we have already established firm and mutual-benefit business relationships with customers from,Europe,America and south Asia,supplying obsolete and hard-to-find components to meet their specific needs.

With the principle of “Quality Parts,Customers Priority,Honest Operation,and Considerate Service”,our business mainly focus on the distribution of electronic components. Line cards we deal with include Microchip,ALPS,ROHM,Xilinx,Pulse,ON,Everlight and Freescale. Main products comprise IC,Modules,Potentiometer,IC Socket,Relay,Connector.Our parts cover such applications as commercial,industrial, and automotives areas.

We are looking forward to setting up business relationship with you and hope to provide you with the best service and solution. Let us make a better world for our industry!



Contact us

Tel: +86-755-8981 8866 Fax: +86-755-8427 6832

Email & Skype: info@chipsmall.com Web: www.chipsmall.com

Address: A1208, Overseas Decoration Building, #122 Zhenhua RD., Futian, Shenzhen, China



THIS DRAWING IS UNPUBLISHED. RELEASED FOR PUBLICATION
 © COPYRIGHT - BY TYCO ELECTRONICS CORPORATION. ALL RIGHTS RESERVED.

LOC	DIST	REVISIONS					
H	-	P	LTR	DESCRIPTION	DATE	DWN	APVD
		A		DRAWING RELEASED PER ECR-11-017294	22AUG2011	JvdH	TdB

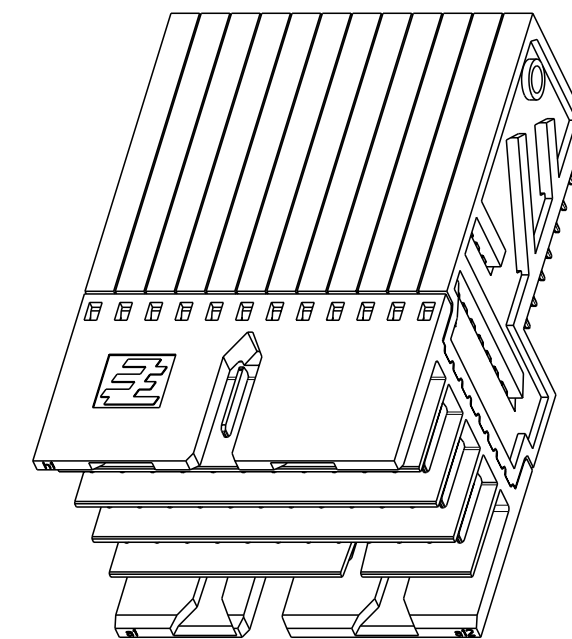
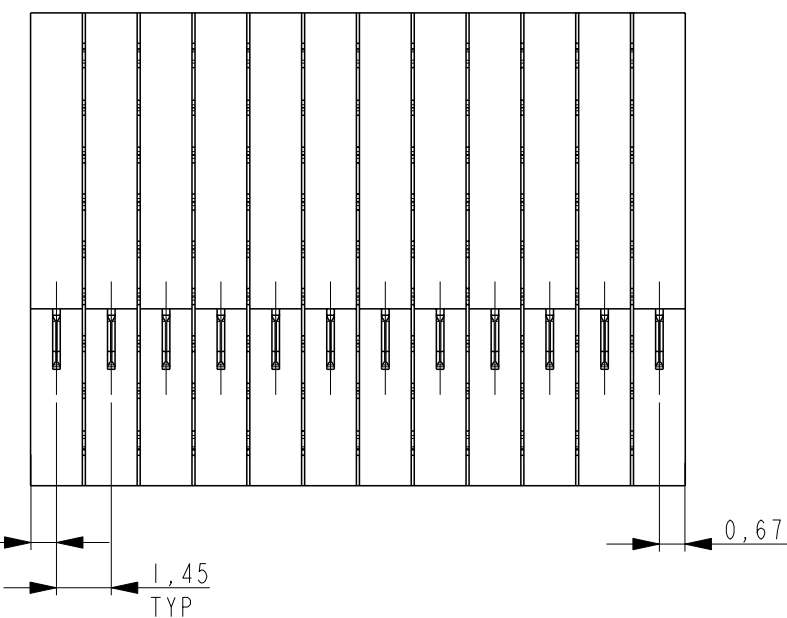
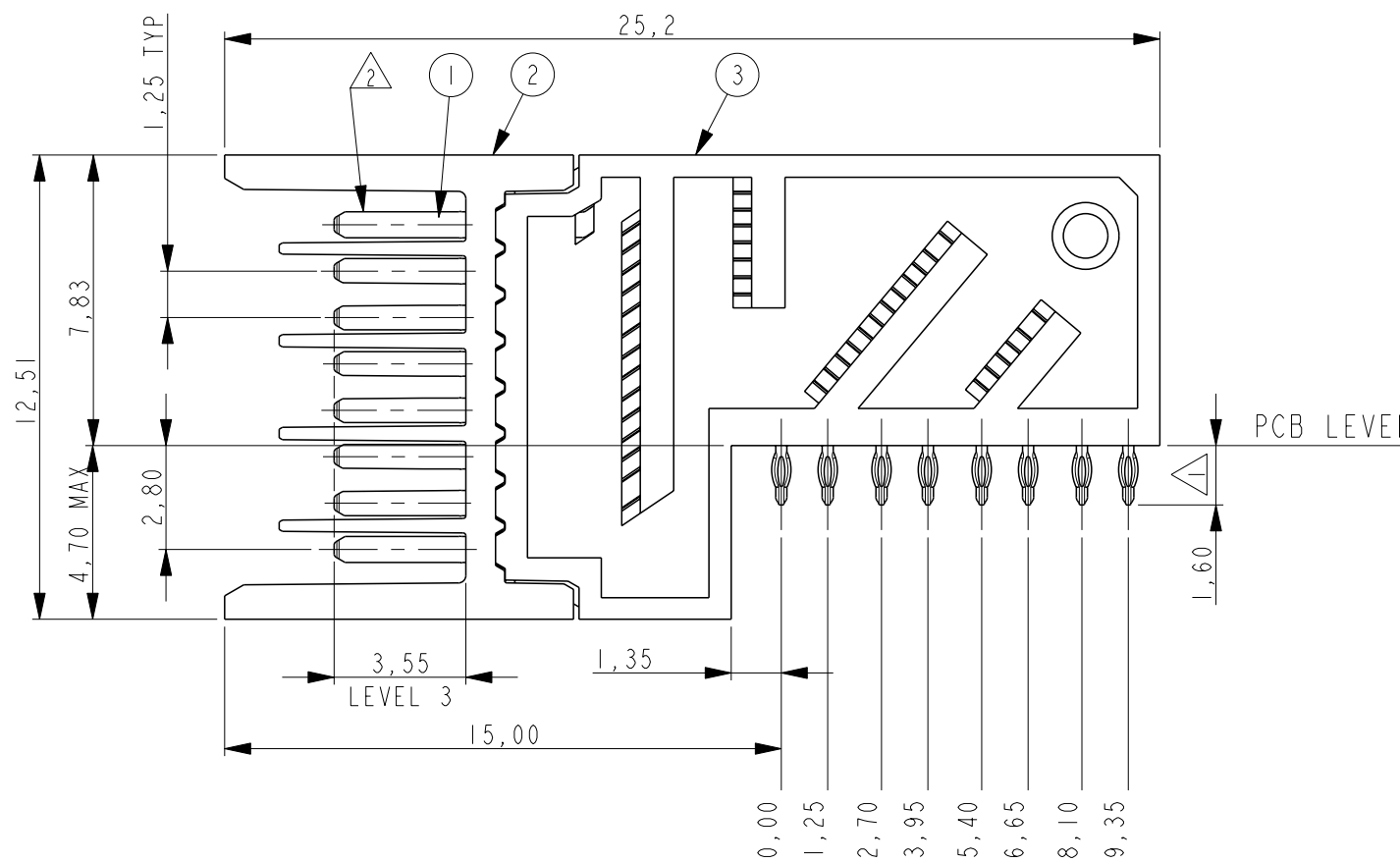
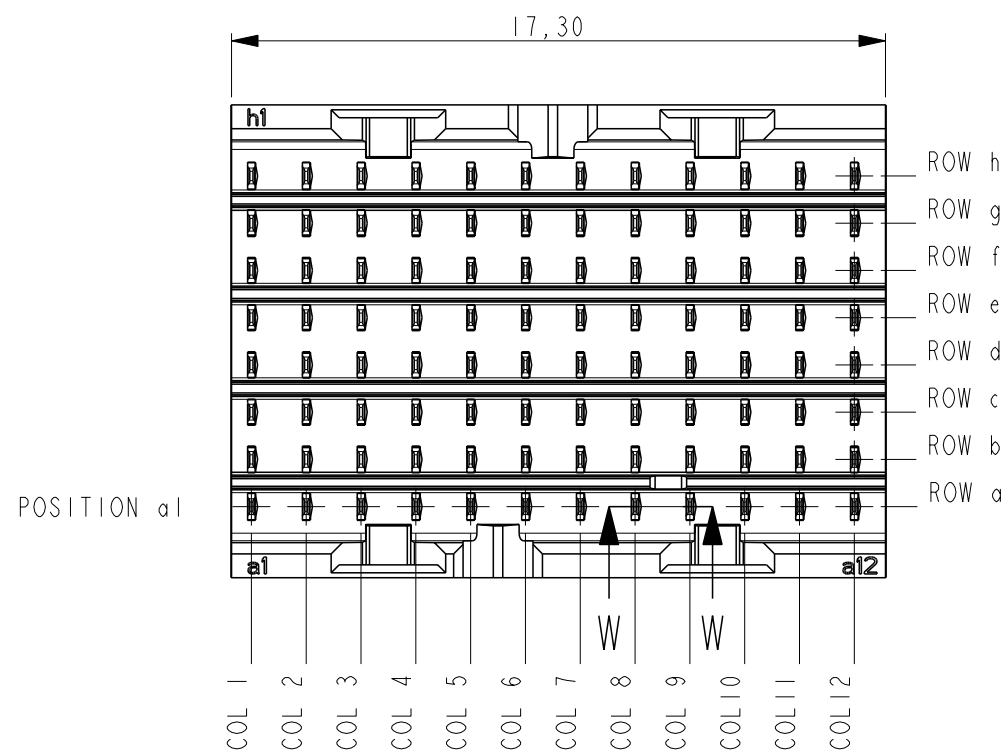
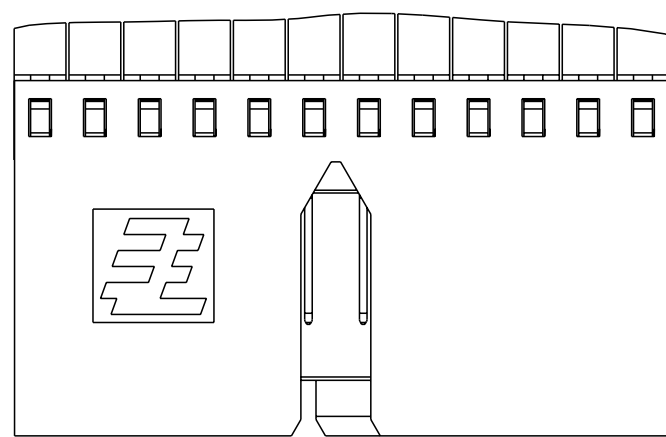

SCALE 3:1

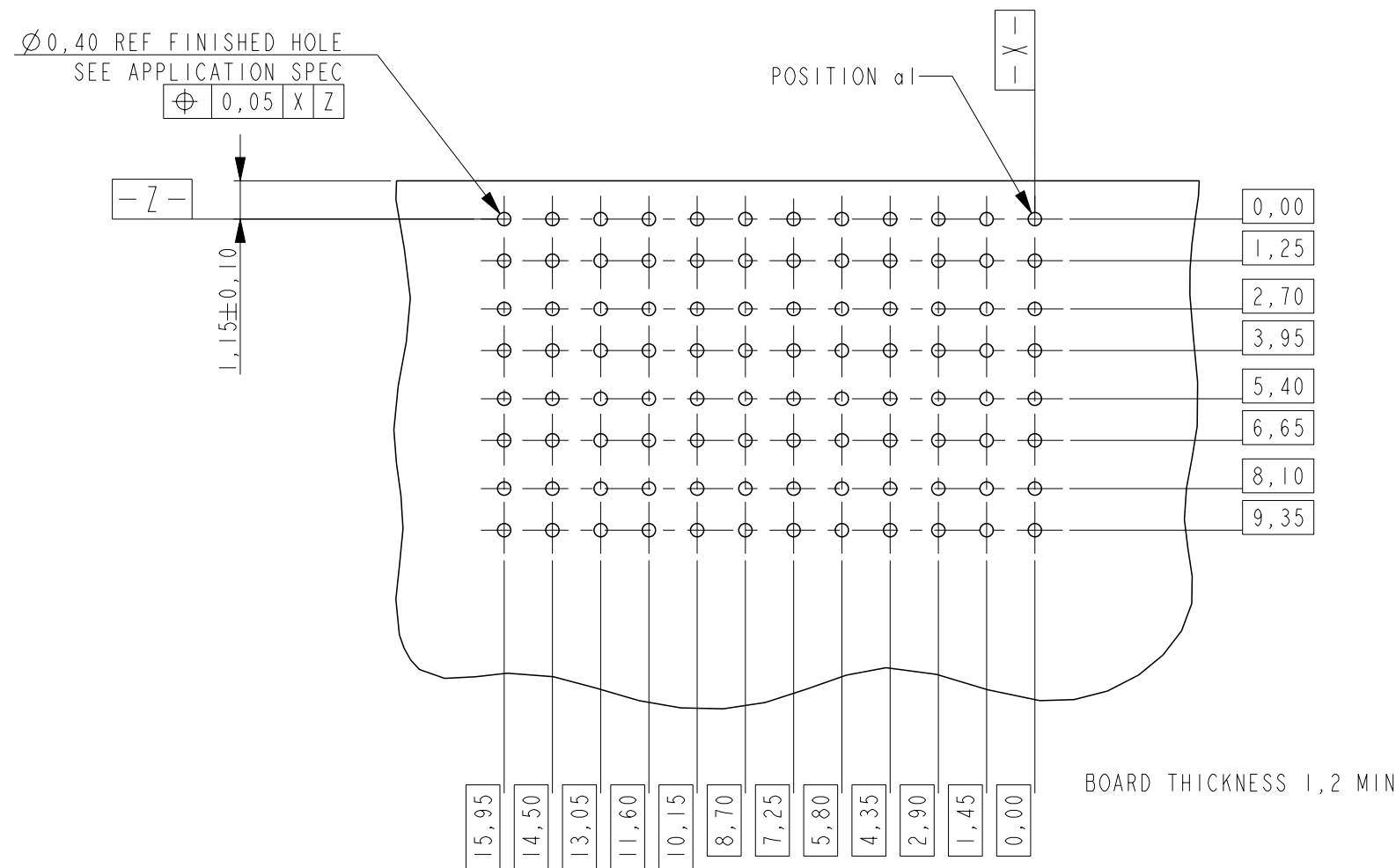
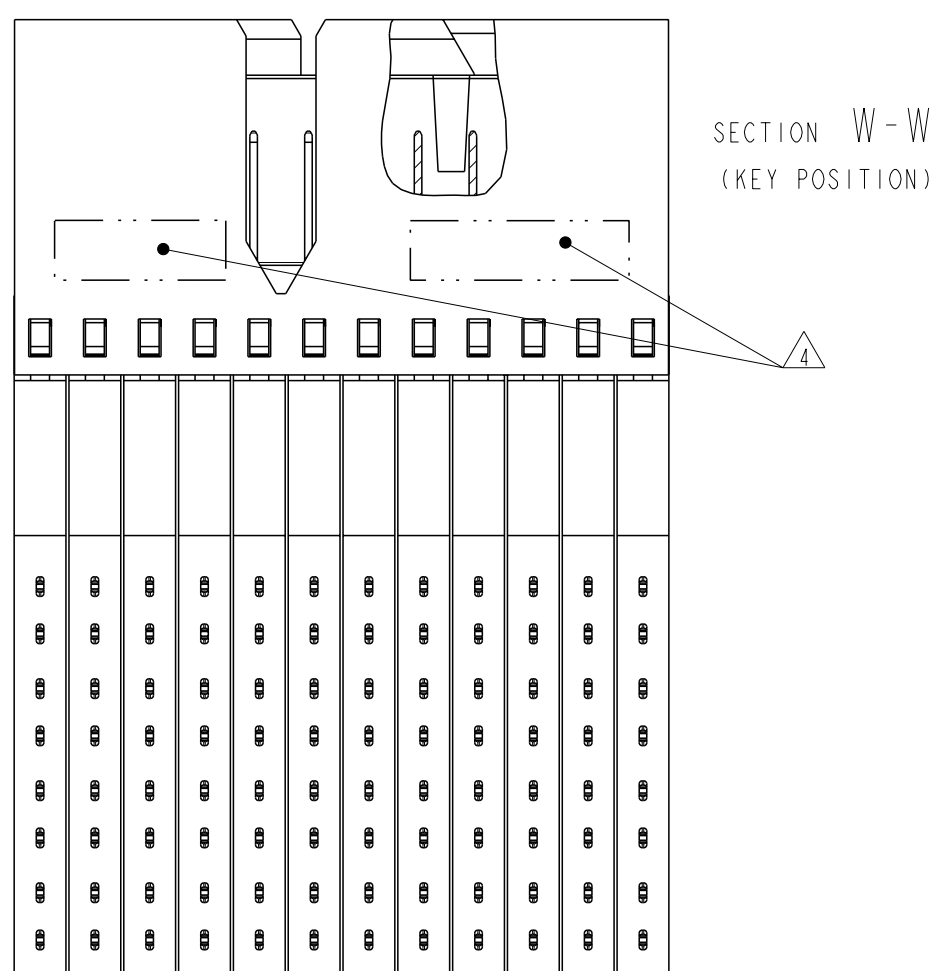

BOARD THICKNESS 1,2 MIN

PRODUCT HAS NOT COMPLETED QUALIFICATION TESTING

NOTES:

- △ PLATING: 0,5µm MIN. TIN OVER NICKEL.
- △ PLATING:

PARTNUMBER	PERFORMANCE LEVEL
2042139-1	PERFORMANCE LEVEL 1: CONNECTOR TESTED AND QUALIFIED AGAINST TELCORDIA GR-1217-CORE QUALITY LEVEL 111: UNCONTROLLED ENVIRONMENT APPLICATIONS. SEE PRODUCT SPEC 108-19353
2042139-2	PERFORMANCE LEVEL 2: CONFORMS TO ALL TESTING ACCORDING PRODUCT SPEC 108-19320, -250 MATING CYCLES, 4 DAYS MIXED GAS TEST PER IEC 60068-2-60 METHOD 1

- 3 CONSULT APPLICATION SPEC OR CONTACT TE CONNECTIVITY FOR PERMISSIBLE CONTACT ASSIGNMENTS.
- △ CONNECTOR MARKED WITH PARTNUMBER AND DATE CODE.
- 5 FOR PC-BOARD ROUTING RECOMMENDATIONS SEE SPEC 114-19140

RECOMMENDED PCB LAYOUT (COMPONENT SIDE SHOWN)

THIS DRAWING IS A CONTROLLED DOCUMENT.		DWN RA 15-Apr-09
DIMENSIONS: mm		CHK RA 15-Apr-09
TOLERANCES UNLESS OTHERWISE SPECIFIED:		APVD -
0 PLC ±		PRODUCT SPEC
1 PLC ±		SEE NOTE △
2 PLC ±		APPLICATION SPEC
3 PLC ±		114-19106
4 PLC ±		WEIGHT -
ANGLES ±		CUSTOMER DRAWING
FINISH		

ITEM NO.	DESCRIPTION	MATERIAL
3	OVERMOLD	PBT 20% GF GREY
2	HOUSING	LCP 30% GF NATURAL
1	CONTACT	COPPER ALLOY

STE TE Connectivity

NAME: RIGHT ANGLE MALE CONNECTOR Z-PACK Slim UHD Common Speed

SIZE	CAGE CODE	DRAWING NO	RESTRICTED TO
A2	00779	2042139	-

SCALE 5:1 SHEET 1 OF 1 REV A