



Chipsmall Limited consists of a professional team with an average of over 10 year of expertise in the distribution of electronic components. Based in Hongkong, we have already established firm and mutual-benefit business relationships with customers from,Europe,America and south Asia,supplying obsolete and hard-to-find components to meet their specific needs.

With the principle of “Quality Parts,Customers Priority,Honest Operation,and Considerate Service”,our business mainly focus on the distribution of electronic components. Line cards we deal with include Microchip,ALPS,ROHM,Xilinx,Pulse,ON,Everlight and Freescale. Main products comprise IC,Modules,Potentiometer,IC Socket,Relay,Connector.Our parts cover such applications as commercial,industrial, and automotives areas.

We are looking forward to setting up business relationship with you and hope to provide you with the best service and solution. Let us make a better world for our industry!



Contact us

Tel: +86-755-8981 8866 Fax: +86-755-8427 6832

Email & Skype: info@chipsmall.com Web: www.chipsmall.com

Address: A1208, Overseas Decoration Building, #122 Zhenhua RD., Futian, Shenzhen, China



5

4

3

2

1

1:1

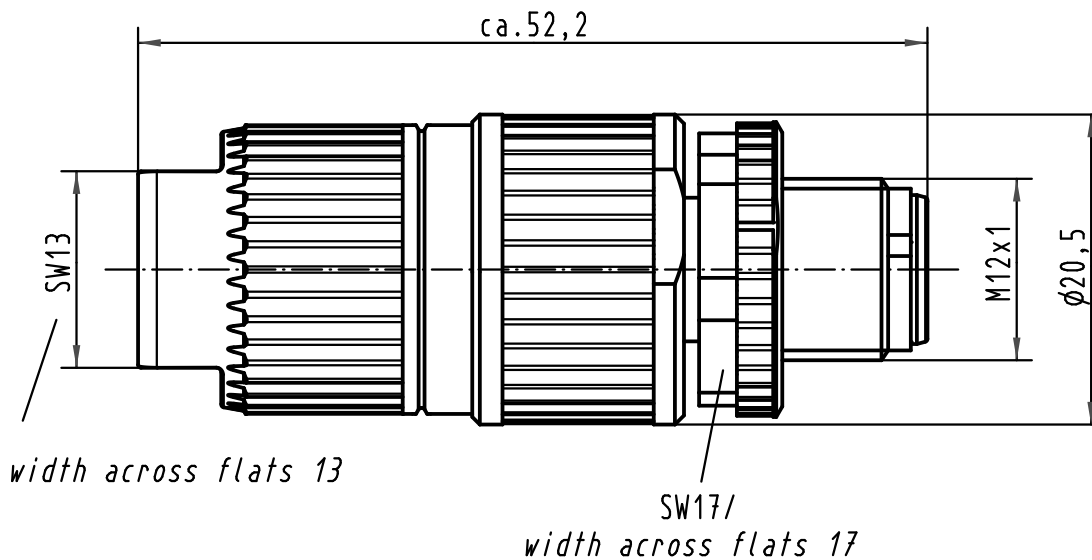
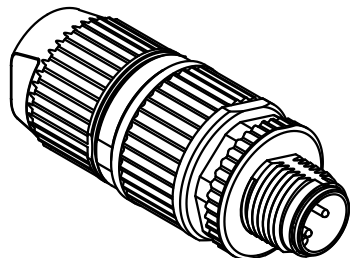
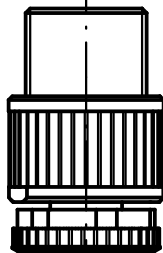
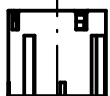
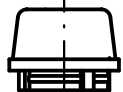
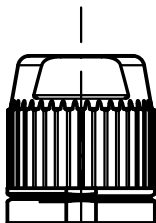

X

X

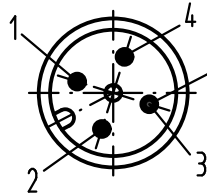

Steckgesicht n.
Contact face acc.
IEC 61076-2-101

Leiterquerschnitt conductor cross section	0,34 - 0,75mm ² AWG22-AWG18
Kabeldurchmesser cable outside diameter	6,0-8,0mm

All Dimensions in mm Original Size DIN A 4			Techn. Character.			Maßstab/Scale 2:1
EC01896	18.05.10	DY		Dat.	Name	
412800	19.03.07	DY	Detail.	10.04.02	Pae	
411606	08.08.05	DY	Insp.		Sr	
410925	10.03.04	DY	Stand.			
410180	30.08.02	Pae	HARTING Electronics GmbH & Co. KG			
410027			D-32339 ESPELKAMP			
Mod.	Dat.	Name				

Nicht tolerierte Maßel Free size tolerances

**Rundsteckverbinder/
Circular connector**
M12-L 4polig Stift/ M12-L 4poles male
bleifrei/lead free

TB 21 03 212 1305

Blatt/ page

Sub.