



Chipsmall Limited consists of a professional team with an average of over 10 year of expertise in the distribution of electronic components. Based in Hongkong, we have already established firm and mutual-benefit business relationships with customers from,Europe,America and south Asia,supplying obsolete and hard-to-find components to meet their specific needs.

With the principle of "Quality Parts,Customers Priority,Honest Operation,and Considerate Service",our business mainly focus on the distribution of electronic components. Line cards we deal with include Microchip,ALPS,ROHM,Xilinx,Pulse,ON,Everlight and Freescale. Main products comprise IC,Modules,Potentiometer,IC Socket,Relay,Connector.Our parts cover such applications as commercial,industrial, and automotives areas.

We are looking forward to setting up business relationship with you and hope to provide you with the best service and solution. Let us make a better world for our industry!



Contact us

Tel: +86-755-8981 8866 Fax: +86-755-8427 6832

Email & Skype: info@chipsmall.com Web: www.chipsmall.com

Address: A1208, Overseas Decoration Building, #122 Zhenhua RD., Futian, Shenzhen, China



THIS DRAWING IS UNPUBLISHED. RELEASED FOR PUBLICATION 20
 © COPYRIGHT 20 BY - ALL RIGHTS RESERVED.

LOC	DIST	REVISIONS					
GP	00	P	LTR	DESCRIPTION	DATE	DWN	APVD
		B		REVISED PER ECO-11-006746	04/APR/11	ECC	PJB
		C		REVISED PER ECR-11-013082	23/JUN/11	ECC	PJB
		E		ECR-12-019784	19NOV2012	TB	DM

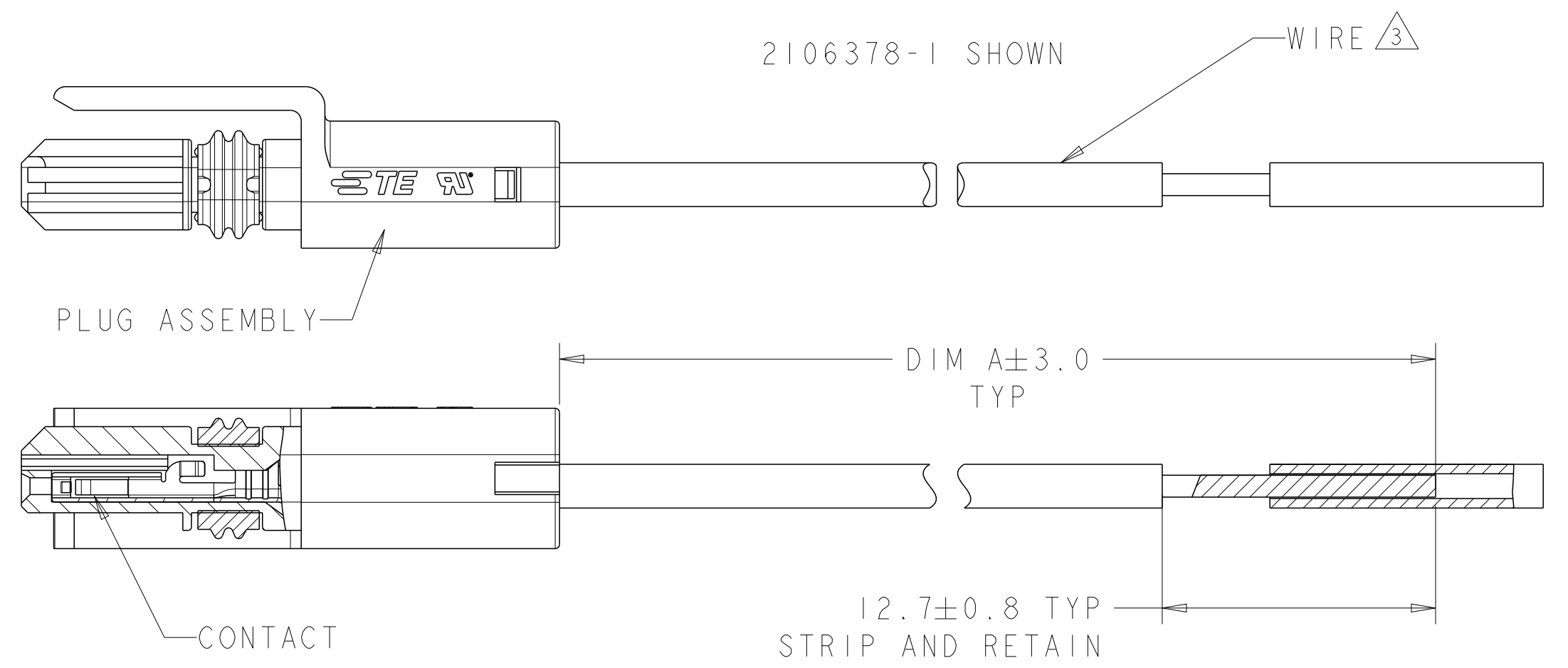

- ⚠ MATERIALS AND FINISH:
 - CONTACTS: COPPER ALLOY
 FINISH: TIN IN CONTACT AREA OVER NICKEL UNDERPLATE
 - WIRE: 18 AWG, STRANDED, UL 1007 STYLE
- 2. MUST COMPLY WITH DIRECTIVE 2002/95/EC (ROHS)
- ⚠ REFERENCE CHART FOR SPECIFIC WIRE COLOR/POSITION.
- ⚠ CONTACTS 0.000381 THK GOLD STRIPE PRE-PLATED STOCK, REF.

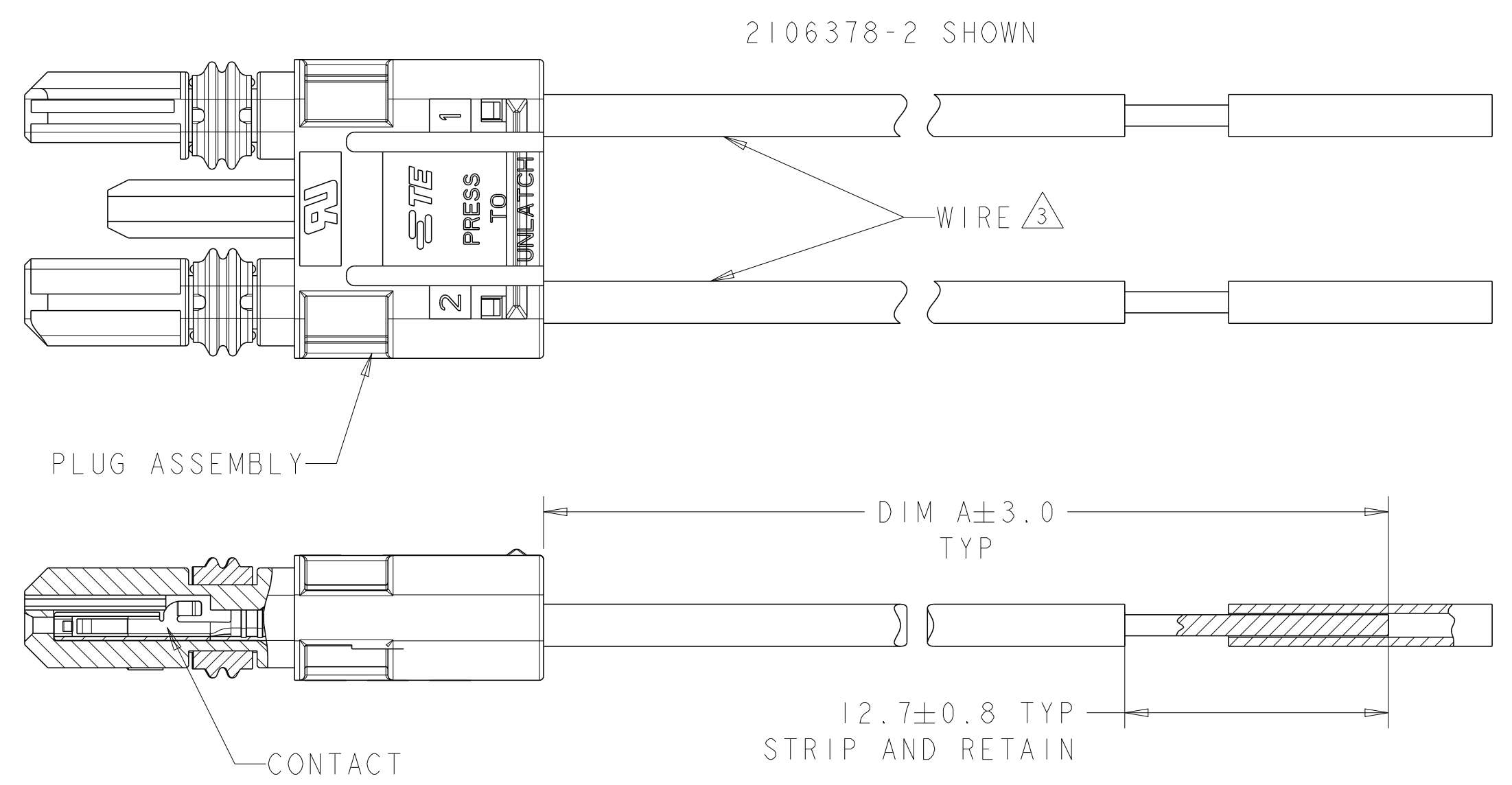

⚠	304.8	20 AWG	4	3-2106378-3
⚠	304.8	20 AWG	2	3-2106378-1
⚠	101.6	20 AWG	2	2-2106378-8
	381.0	18 AWG	2	2-2106378-6
	304.8	24 AWG	4	2-2106378-5
	304.8	24 AWG	3	2-2106378-4
	304.8	24 AWG	2	2-2106378-3
	101.6	24 AWG	4	2-2106378-2
	101.6	24 AWG	3	2-2106378-1
	101.6	24 AWG	2	2-2106378-0
	304.8	22 AWG	4	1-2106378-9
	304.8	22 AWG	3	1-2106378-8
	304.8	22 AWG	2	1-2106378-7
	101.6	22 AWG	4	1-2106378-6
	101.6	22 AWG	3	1-2106378-5
	101.6	22 AWG	2	1-2106378-4
	304.8	20 AWG	4	1-2106378-3
	304.8	20 AWG	3	1-2106378-2
	304.8	20 AWG	2	1-2106378-1
	101.6	20 AWG	4	1-2106378-0
	101.6	20 AWG	3	2106378-9
	101.6	20 AWG	2	2106378-8
	304.8	18 AWG	4	2106378-7
	304.8	18 AWG	3	2106378-6
	304.8	18 AWG	2	2106378-5
	101.6	18 AWG	4	2106378-4
	101.6	18 AWG	3	2106378-3
	101.6	18 AWG	2	2106378-2
	101.6	18 AWG	1	2106378-1
DIM A	WIRE SIZE	POSN	PART NO.	

WIRE COLOR CHART

4	-	-	-	BLUE	-	-	BLUE	-	-	BLUE	-	-	BLUE	-	-	BLUE	-	-	BLUE	-	-	BLUE	-	-	BLUE	-	
3	-	-	WHITE	WHITE	-	WHITE	WHITE	-	WHITE	WHITE	-	WHITE	WHITE	-	WHITE	WHITE	-	WHITE	WHITE	-	WHITE	WHITE	-	WHITE	WHITE	-	
2	-	RED	RED	RED	RED	RED	RED	RED	RED	RED	RED	RED	RED	RED	RED	RED	RED	RED	RED	RED	RED	RED	RED	RED	RED	RED	BLACK
1	BLACK	BLACK	BLACK	BLACK	BLACK	BLACK	BLACK	BLACK	BLACK	BLACK	BLACK	BLACK	BLACK	BLACK	BLACK	BLACK	BLACK	BLACK	BLACK	BLACK	BLACK	BLACK	BLACK	BLACK	BLACK	BLACK	RED
POS	-1	-2	-3	-4	-5	-6	-7	-8	-9	-10	-11	-12	-13	-14	-15	-16	-17	-18	-19	-20	-21	-22	-23	-24	-25	-26	

4	-	-	-	-	-	-	BLUE
3	-	-	-	-	-	-	WHITE
2	-	RED	-	-	RED	-	RED
1	-	BLACK	-	-	BLACK	-	BLACK
POS	-27	-28	-29	-30	-31	-32	-33

THIS DRAWING IS A CONTROLLED DOCUMENT.

DWN: R BROWN 16APR2009
 CHK: M MOSTOLLER 16APR2009
 APVD: -

STE TE Connectivity

CABLE ASSEMBLY, PLUG, SLIMSEAL SSL CONNECTOR

SIZE: A2 CAGE CODE: 00779 DRAWING NO: 2106378 RESTRICTED TO: -

MATERIAL: - DIMENSIONS: mm TOLERANCES UNLESS OTHERWISE SPECIFIED: 0 PLC ±, 1 PLC ±0.2, 2 PLC ±, 3 PLC ±, 4 PLC ±, ANGLES ±, FINISH ±

PRODUCT SPEC: - APPLICATION SPEC: - WEIGHT: -

CUSTOMER DRAWING SCALE: 1:1 SHEET 1 OF 3 REV E

THIS DRAWING IS UNPUBLISHED. RELEASED FOR PUBLICATION 20
 © COPYRIGHT 20 BY - ALL RIGHTS RESERVED.

LOC	DIST	REVISIONS					
GP	00	P	LTR	DESCRIPTION	DATE	DWN	APVD
		-		SEE SHEET 1	-	-	-

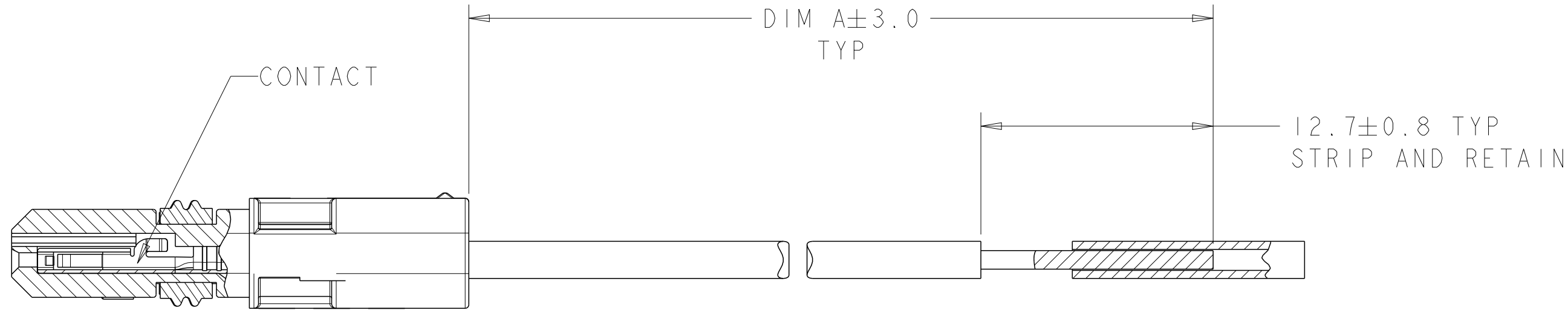
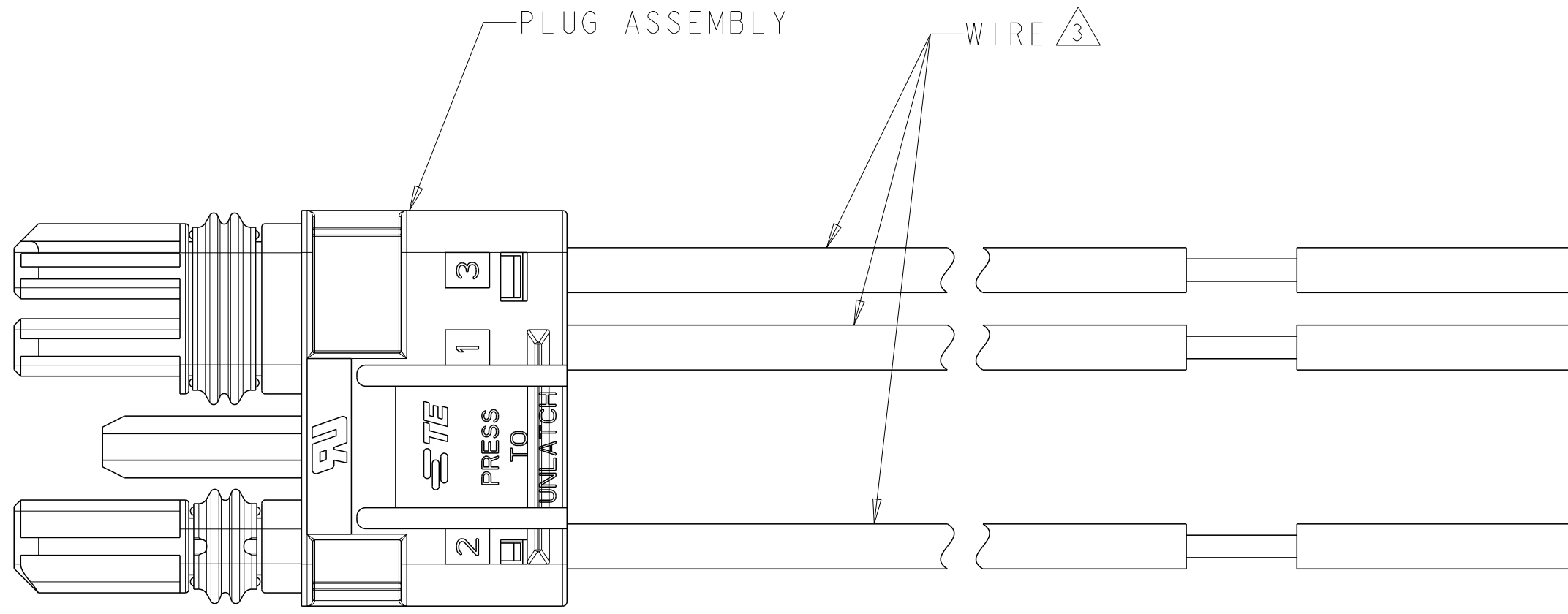

2106378-3 SHOWN

THIS DRAWING IS A CONTROLLED DOCUMENT.		DWN R BROWN 16APR2009	TE Connectivity		
DIMENSIONS: mm		CHK M MOSTOLLER 16APR2009			
TOLERANCES UNLESS OTHERWISE SPECIFIED:		APVD -	NAME CABLE ASSEMBLY, PLUG, SLIMSEAL SSL CONNECTOR		
0 PLC ±		PRODUCT SPEC -	SIZE A200779		
1 PLC ±0.2		APPLICATION SPEC -	CAGE CODE C-2106378		
2 PLC ±		WEIGHT -	DRAWING NO -		
3 PLC ±		MATERIAL -	RESTRICTED TO -		
4 PLC ±			SCALE 1:1		
ANGLES ±		SHEET 2 OF 3			
FINISH ±		REV E			
		CUSTOMER DRAWING			

THIS DRAWING IS UNPUBLISHED. RELEASED FOR PUBLICATION 20
 © COPYRIGHT 20 BY - ALL RIGHTS RESERVED.

LOC	DIST	REVISIONS					
GP	00	P	LTR	DESCRIPTION	DATE	DWN	APVD
		-		SEE SHEET 1	-	-	-

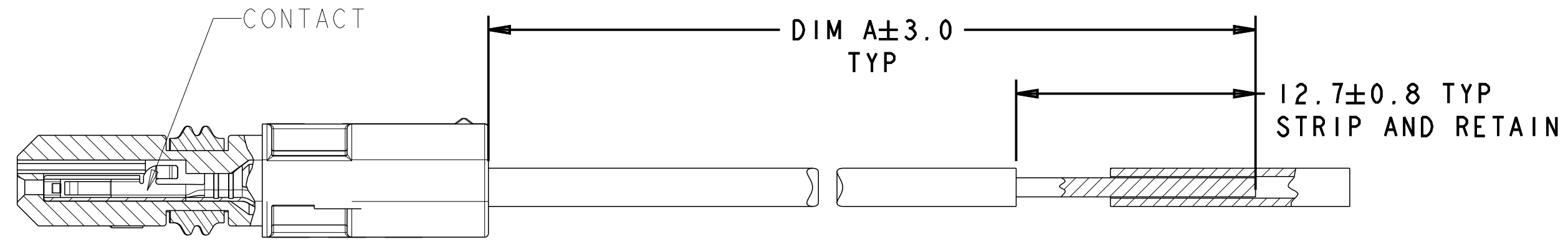
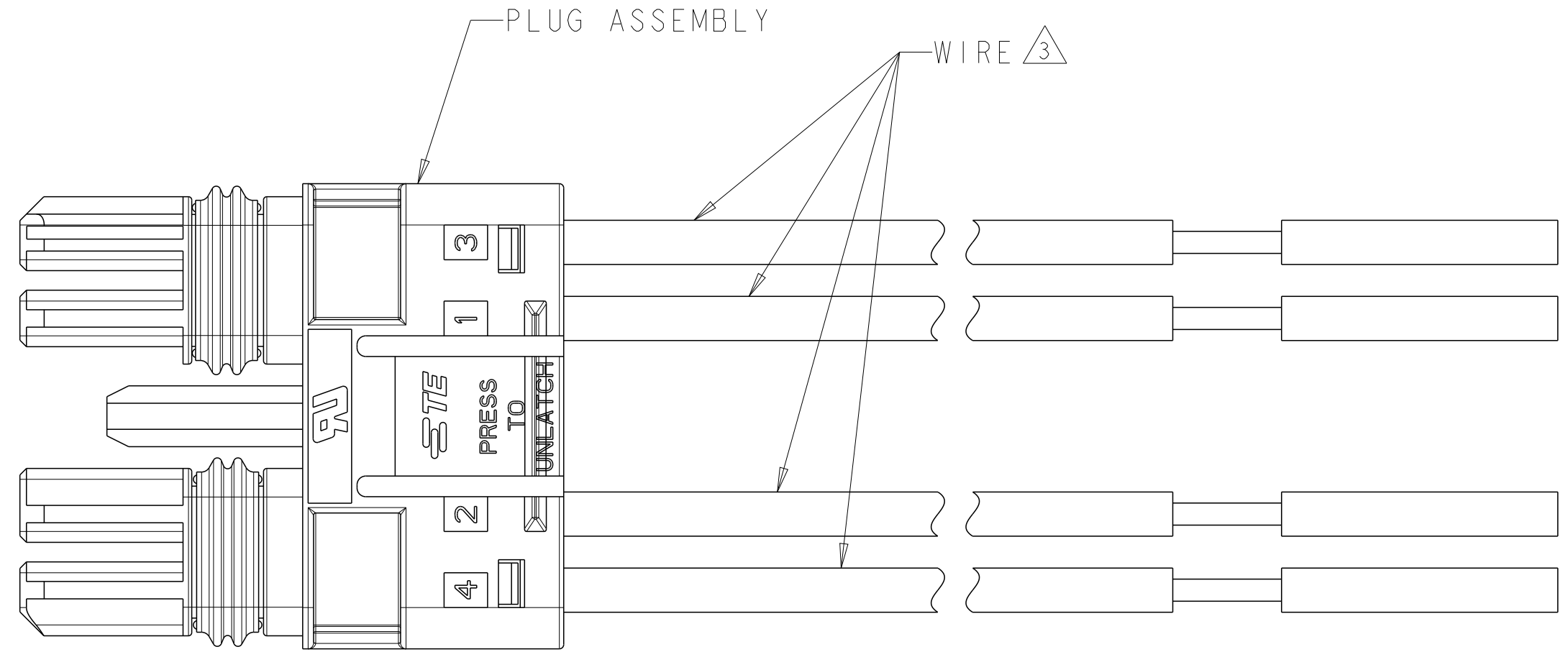

2106378-4 SHOWN

THIS DRAWING IS A CONTROLLED DOCUMENT.		DWN R BROWN 16APR2009	 TE Connectivity	
DIMENSIONS: mm		CHK M MOSTOLLER 16APR2009		
TOLERANCES UNLESS OTHERWISE SPECIFIED:		APVD -	NAME CABLE ASSEMBLY, PLUG, SLIMSEAL SSL CONNECTOR	
0 PLC ±-		PRODUCT SPEC -	SIZE A200779	
1 PLC ±0.2		APPLICATION SPEC -	CAGE CODE C-2106378	DRAWING NO -
2 PLC ±-		WEIGHT -	RESTRICTED TO -	
3 PLC ±-		CUSTOMER DRAWING	SCALE 1:1	SHEET 3 OF 3
4 PLC ±-			REV E	
ANGLES ±-				
FINISH				