



Chipsmall Limited consists of a professional team with an average of over 10 year of expertise in the distribution of electronic components. Based in Hongkong, we have already established firm and mutual-benefit business relationships with customers from,Europe,America and south Asia,supplying obsolete and hard-to-find components to meet their specific needs.

With the principle of "Quality Parts,Customers Priority,Honest Operation,and Considerate Service",our business mainly focus on the distribution of electronic components. Line cards we deal with include Microchip,ALPS,ROHM,Xilinx,Pulse,ON,Everlight and Freescale. Main products comprise IC,Modules,Potentiometer,IC Socket,Relay,Connector.Our parts cover such applications as commercial,industrial, and automotives areas.

We are looking forward to setting up business relationship with you and hope to provide you with the best service and solution. Let us make a better world for our industry!



Contact us

Tel: +86-755-8981 8866 Fax: +86-755-8427 6832

Email & Skype: info@chipsmall.com Web: www.chipsmall.com

Address: A1208, Overseas Decoration Building, #122 Zhenhua RD., Futian, Shenzhen, China



THIS DRAWING IS UNPUBLISHED. RELEASED FOR PUBLICATION 20

© COPYRIGHT 20 BY - ALL RIGHTS RESERVED.

REVISIONS

P	LTR	DESCRIPTION	DATE	DWN	APVD
3		REMOVE CORNER HOLE	01SEP2016	VL	SS
A		DRAWING RELEASED	21APR2017	VL	SS
A1		REVISED PER ECO-17-007644	26MAY2017	VL	SS
A2		REVISED PER ECO-17-013857	20SEP2017	SS	HL

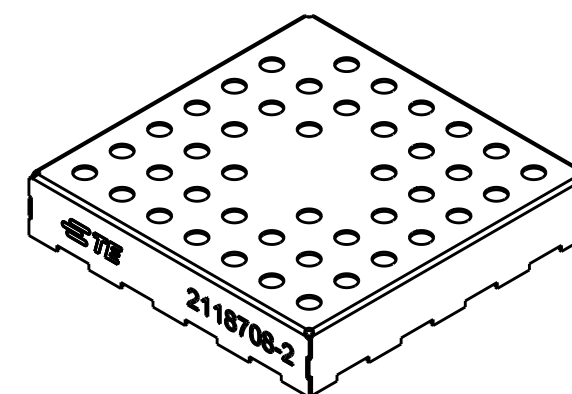
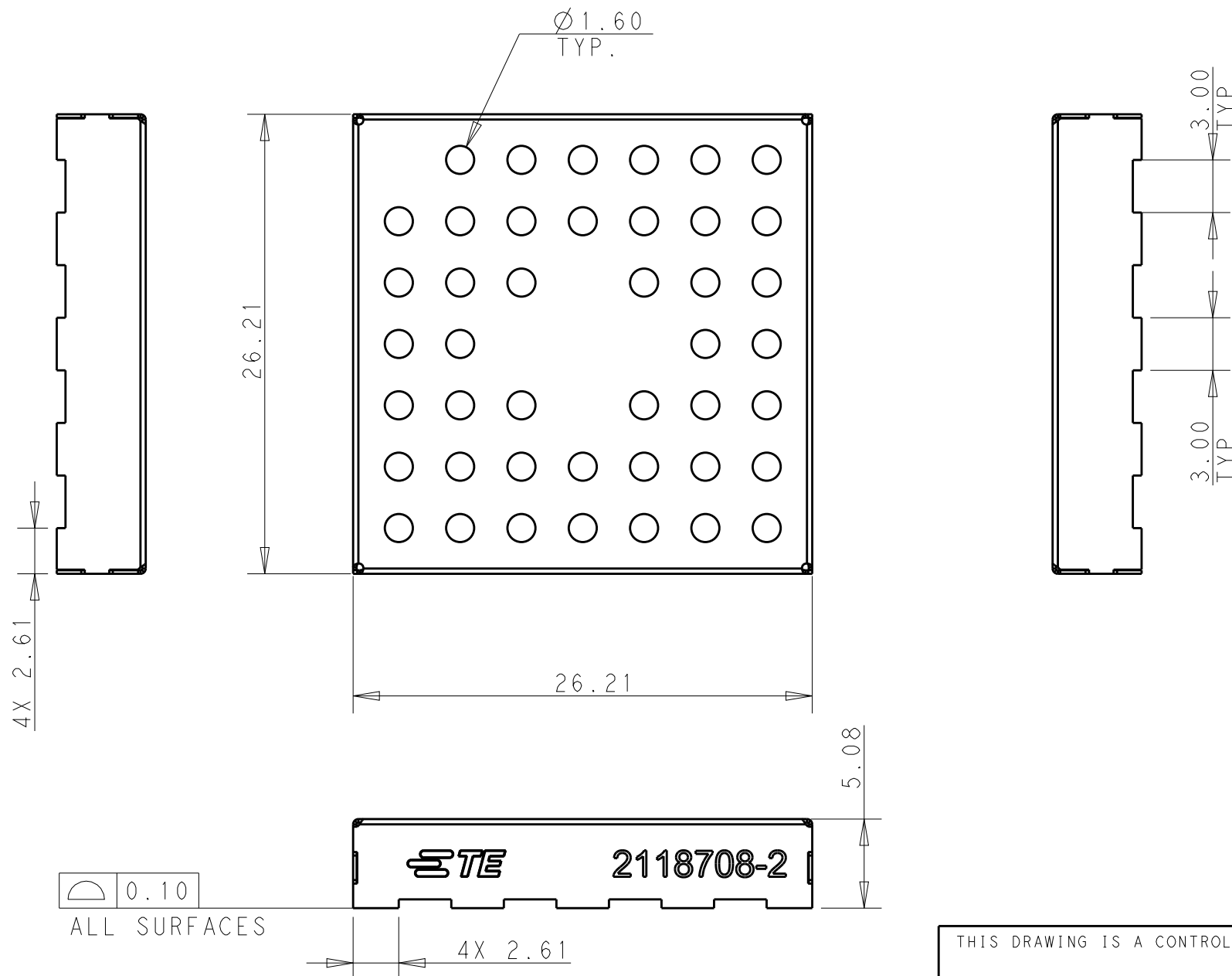

NOTES:

- 1 MATERIAL: 0.20mm CRS. 1,25 - 3.00µm MATTE TIN FINISH.
- 2 MATERIAL: 0.20mm AL. 1.20 - 2.00µm MATTE TIN FINISH OVER NICKEL FLASH.
- 3 STAMPING BURR OUTSIDE OF PART, MAX 0.05mm.
- 4 PARTS TO BE FREE OF OIL AND CONTAMINENTS.
- 5 PART IS RoHS COMPLIANT PER TE CONNECTIVITY STANDARD TEC-138-702.
- 6 REFER TO 3D MODEL FOR UNSPECIFIED DIMENSIONS.
- 7 PACKAGING: TAPE AND REEL

7	2	2118708-4
7	1	2118708-2
PACKAGING	MATERIAL	PART NUMBER

THIS DRAWING IS A CONTROLLED DOCUMENT.		DWN V. LAC 07APR2016	TE Connectivity	
DIMENSIONS: mm		CHK S. SU 21APR2017		
TOLERANCES UNLESS OTHERWISE SPECIFIED:		APVD V. LAC 21APR2017	NAME 1 PIECE STANDARD SHIELD	
0 PLC ±0.20		PRODUCT SPEC 108-115119	SIZE A3	
1 PLC ±0.15		APPLICATION SPEC 114-115013	CAGE CODE -	DRAWING NO C-2118708
2 PLC ±0.10		WEIGHT -	RESTRICTED TO -	
3 PLC ±		CUSTOMER DRAWING	SCALE 3:1	SHEET 1 OF 3
4 PLC ±				REV A2
4 PLC ANGLES ±2				
MATERIAL SEE TABLE				
FINISH SEE TABLE				

THIS DRAWING IS UNPUBLISHED.

RELEASED FOR PUBLICATION

20

© COPYRIGHT 20 BY -

ALL RIGHTS RESERVED.

REVISIONS

P	LTR	DESCRIPTION	DATE	DWN	APVD
-		SEE SHEET 1	-	-	-

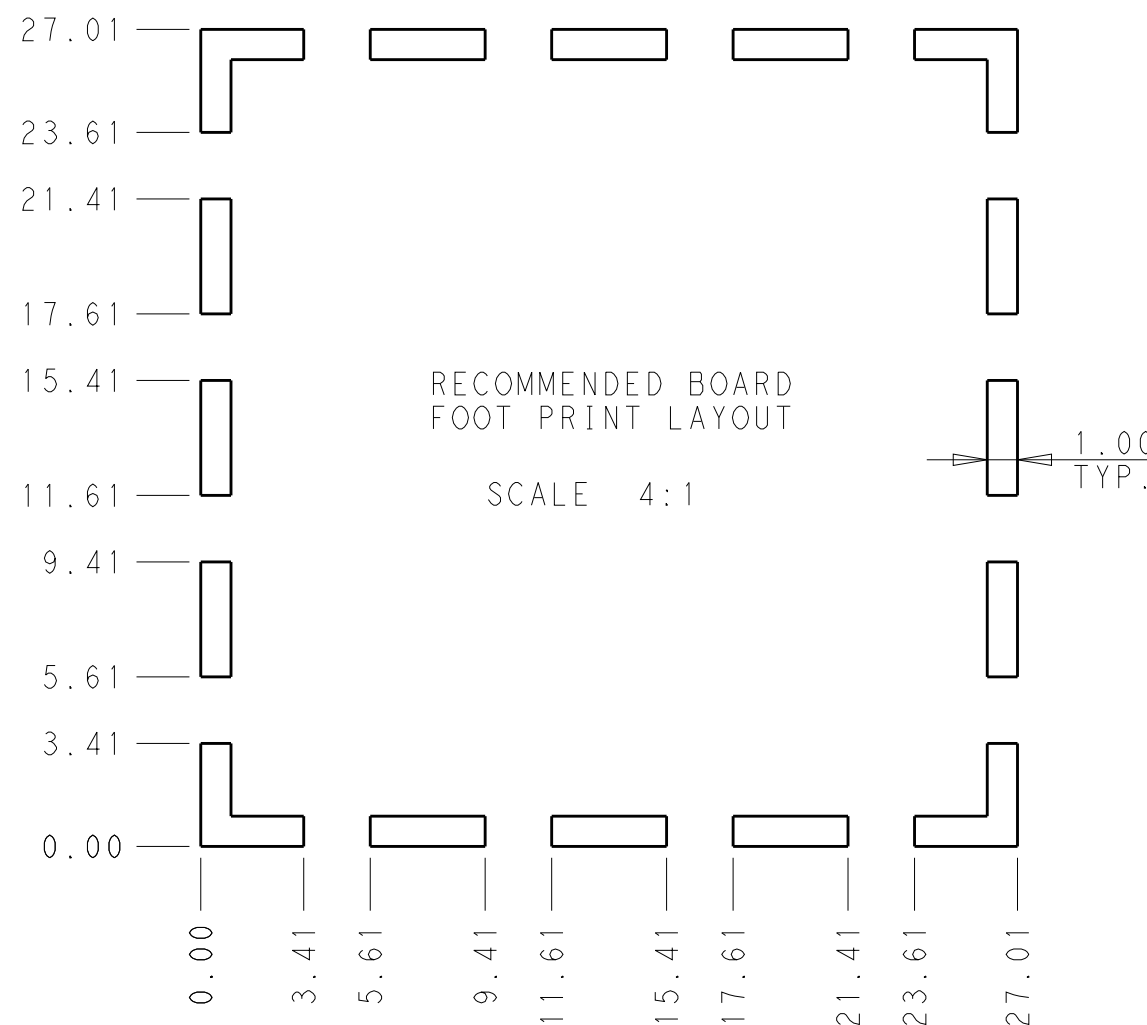

NOTES:
8. STENCIL THICKNESS: 0.10mm MIN.

THIS DRAWING IS A CONTROLLED DOCUMENT.

DIMENSIONS:
mm

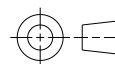

TOLERANCES UNLESS OTHERWISE SPECIFIED:

- 0 PLC ±0.20
- 1 PLC ±0.15
- 2 PLC ±0.10
- 3 PLC ±
- 4 PLC ±
- ANGLES ±2

MATERIAL
SEE TABLE

FINISH
SEE TABLE

DWN V. LAC 07APR2016

CHK S. SU 21APR2017

APVD V. LAC 21APR2017

PRODUCT SPEC
108-115119

APPLICATION SPEC
114-115013

WEIGHT -

CUSTOMER DRAWING



NAME
1 PIECE STANDARD SHIELD

SIZE	CAGE CODE	DRAWING NO	RESTRICTED TO
A3	-	C-2118708	-

SCALE	SHEET	OF	REV
3:1	2	3	A2

THIS DRAWING IS UNPUBLISHED. RELEASED FOR PUBLICATION 20
 © COPYRIGHT 20 BY - ALL RIGHTS RESERVED.

REVISIONS					
P	LTR	DESCRIPTION	DATE	DWN	APVD
-	-	SEE SHEET 1	-	-	-

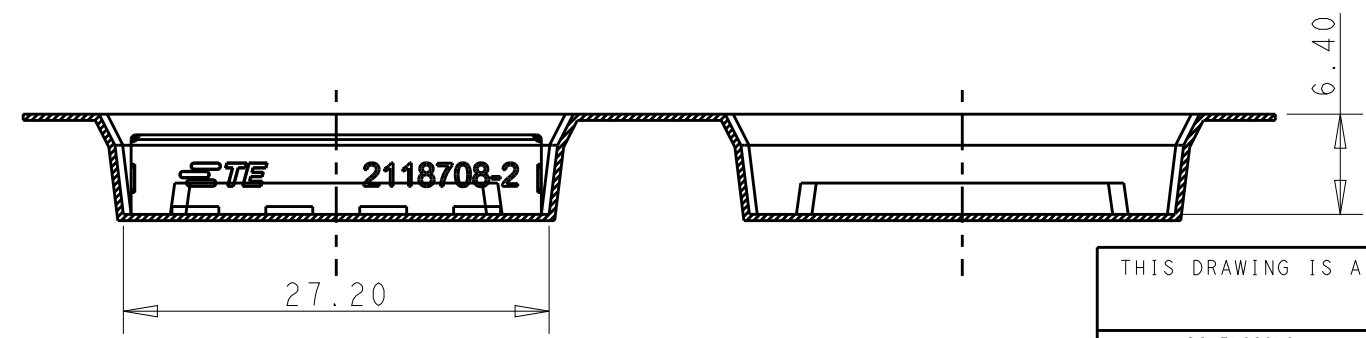
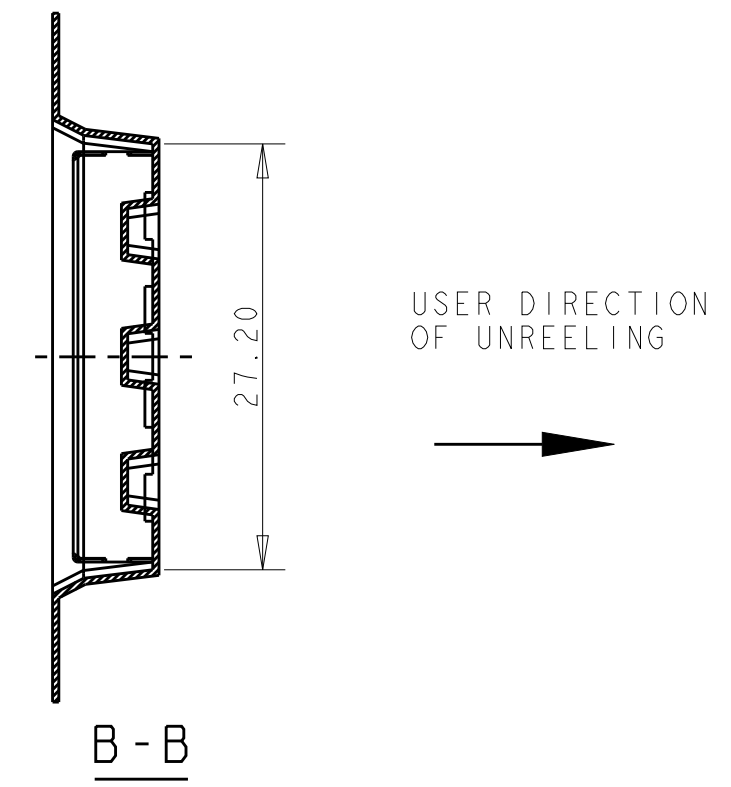
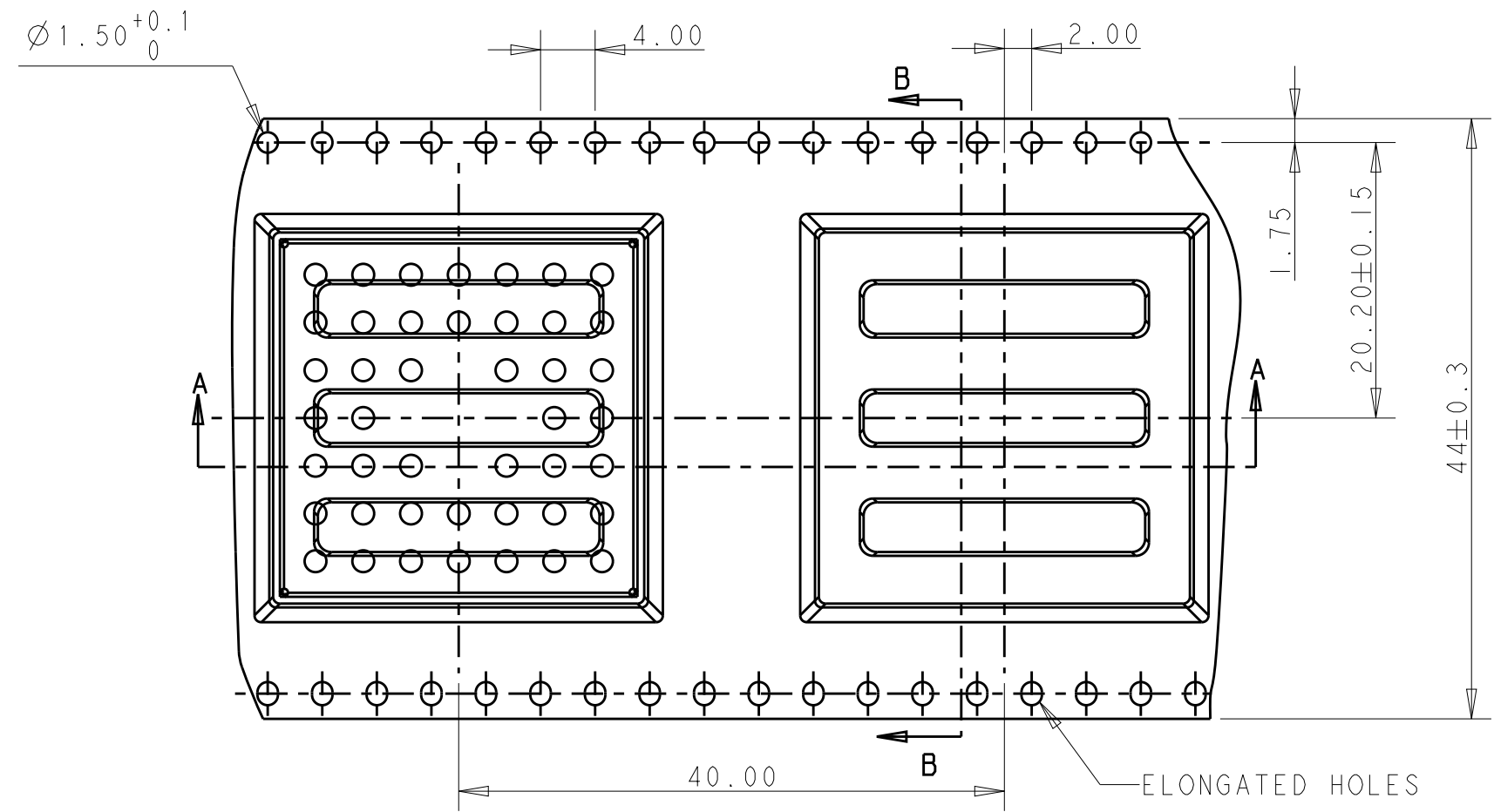

- NOTES:
 9. REEL SIZE: O.D. 380mm, I.D. 180mm
 10. QTY PER REEL: 280PCS

THIS DRAWING IS A CONTROLLED DOCUMENT.		DWN V. LAC 07APR2016	 TE Connectivity	
DIMENSIONS: mm		CHK S. SU 21APR2017		
TOLERANCES UNLESS OTHERWISE SPECIFIED:		APVD V. LAC 21APR2017	NAME 1 PIECE STANDARD SHIELD	
0 PLC ±0.20 1 PLC ±0.15 2 PLC ±0.10 3 PLC ± 4 PLC ± ANGLES ±2		PRODUCT SPEC 108-115119	SIZE A3	
MATERIAL SEE TABLE		APPLICATION SPEC 114-115013	CAGE CODE -	DRAWING NO C-2118708
FINISH SEE TABLE		WEIGHT -	RESTRICTED TO -	
-		CUSTOMER DRAWING	SCALE 3:1	SHEET 3 OF 3
-			REV A2	