



Chipsmall Limited consists of a professional team with an average of over 10 year of expertise in the distribution of electronic components. Based in Hongkong, we have already established firm and mutual-benefit business relationships with customers from,Europe,America and south Asia,supplying obsolete and hard-to-find components to meet their specific needs.

With the principle of “Quality Parts,Customers Priority,Honest Operation,and Considerate Service”,our business mainly focus on the distribution of electronic components. Line cards we deal with include Microchip,ALPS,ROHM,Xilinx,Pulse,ON,Everlight and Freescale. Main products comprise IC,Modules,Potentiometer,IC Socket,Relay,Connector.Our parts cover such applications as commercial,industrial, and automotives areas.

We are looking forward to setting up business relationship with you and hope to provide you with the best service and solution. Let us make a better world for our industry!



## Contact us

Tel: +86-755-8981 8866 Fax: +86-755-8427 6832

Email & Skype: info@chipsmall.com Web: www.chipsmall.com

Address: A1208, Overseas Decoration Building, #122 Zhenhua RD., Futian, Shenzhen, China

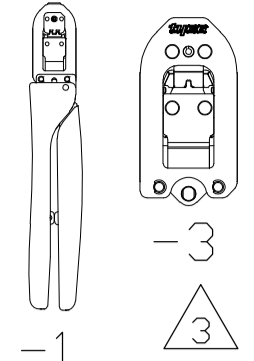
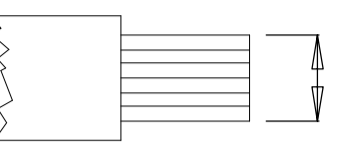
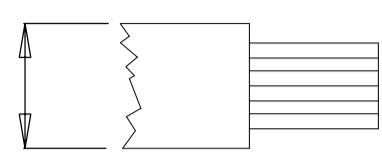
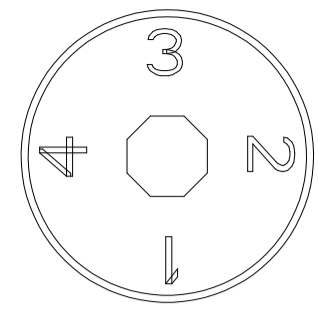
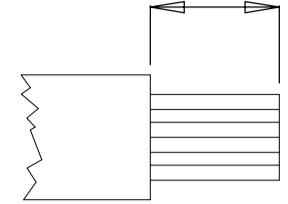
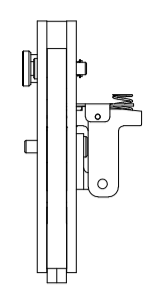
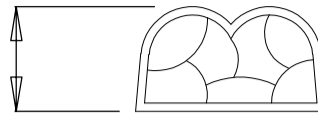
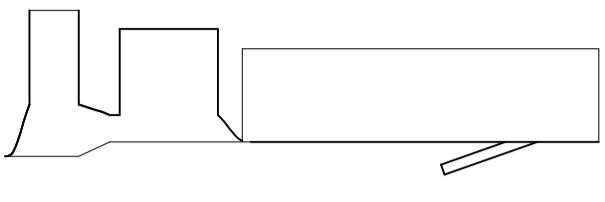
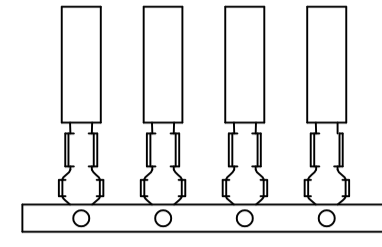

DIMENSIONING AND TOLERANCING PER ASME Y14.5M (ISO STANDARDS). THIS DRAWING IS A CONTROLLED DOCUMENT.

TOOL NUMBER 	WIRE SIZE mm <sup>2</sup> [AWG] 	INSULATION DIAMETER mm [in.] 	INSULATION ADJUST 	STRIP LENGTH mm [in.] 	FLIP LOCATOR 	CRIMP HEIGHT mm [in.] 	CONTACT PART NUMBERS <sup>△</sup>		CONTACT DESCRIPTION	APPLICATION SPECIFICATION
							LOOSE PIECE 	STRIP FORM 		
91558-1 91558-3	0.50 [20] 0.85 [18]	1.80-2.80 [071-.110]	NO	3.8-4.8 [150-.189]	NO	1.05-1.22 [041-.048] 1.05-1.32 [041-.052] 1.35-1.52 [053-.060]	175218-[ ] 175289-[ ]	175196-[ ] 175286-[ ]	DYNAMIC Series D-3(L) Contacts	114-5148
91559-1 91559-3	0.20 [24] 0.30 [22] 0.50 [20]	1.20-1.60 [047-.063] 1.70-2.60 [067-.102]	NO	3.8-4.8 [150-.189]	NO	0.90-1.08 [035-.043] 0.97-1.13 [038-.044] 0.97-1.24 [038-.049]	175217-[ ] 175288-[ ]	175195-[ ] 175285-[ ]	DYNAMIC Series D-3(M) Contacts	114-5148
91560-1 91560-3	1.23-1.42 [16] 1.94-2.20 [14]	2.20-2.80 [087-.110]	NO	4.3-5.3 [169-.209]	NO	1.34-1.52 [053-.060] 1.57-1.76 [062-.069]	917511-[ ] 917512-[ ]	917484-[ ] 917485-[ ]	DYNAMIC Series D-3(2L) Contacts	114-5148
91561-1 91561-3	1.23-1.42 [16] 1.94-2.20 [14]	3.10-3.30 [122-.130] 3.50-3.80 [138-.150]	NO	4.3-5.3 [169-.209]	NO	1.34-1.52 [053-.060] 1.57-1.76 [062-.069]	353718-[ ] 353717-[ ]	353716-[ ] 353715-[ ]	DYNAMIC Series D-3(3L) Contacts	114-5148
91565-1 91565-3	0.08 [28] 0.12 [26] 0.20 [24]	0.80-1.20 [031-.047] 1.00-1.40 [039-.055]	NO	3.8-4.8 [150-.189]	NO	0.67-0.96 [026-.038] 0.67-0.98 [026-.039] 0.84-1.03 [033-.041]	175216-[ ] 175287-[ ]	175194-[ ] 175284-[ ]	DYNAMIC Series D-3(S) Contacts	114-5148
91576-1 91576-3	0.09-0.12 [28-26] 0.2 [24]	0.88-1.30 [035-.051] 1.11-1.43 [044-.056]	YES	2.9-3.9 [114-.154]	YES	0.58-0.7 [023-.028] 0.64-0.77 [025-.030]	1318108-[ ] 1318112-[ ]	1318106-[ ] 1318110-[ ]	DYNAMIC Series D-2(S) Contacts	114-5258
91595-1 91595-3	0.3-0.5 [22-20] 0.85 [18]	1.26-1.80 [050-.071] 1.79-1.90 [070-.075]	YES	2.9-3.9 [114-.154]	NO	0.87-1.03 [034-.041] 1.06-1.24 [042-.049]	1318107-[ ] 1318111-[ ]	1318105-[ ] 1318109-[ ]	DYNAMIC Series D-2(M) Contacts	114-5258
91596-1 91596-3	0.50 - 1.15 [20-18] 1.15-1.42 [16]	1.80-2.83 [071-.111] 2.35-3.23 [093-.127]	NO	4.3-4.8 [169-.189]	NO	1.35-1.50 [053-.059] 1.55-1.70 [061-.067]	1318986-6	1318985-6	DYNAMIC Series D-5(SS) Contacts	114-5206

<sup>△</sup> LIST OF APPLIED CONTACT PART NUMBERS MAY NOT BE COMPLETE AND IS SUBJECT TO CHANGE. FOR CURRENT INFORMATION ON TERMINAL PART NUMBERS, CONTACT THE TOOLING ASSISTANCE CENTER : 1-800-722-1111.



<sup>③</sup> -1 IS A CERTICRIMP II HAND TOOL ASSEMBLY.  
 -3 IS A CERTICRIMP II HEAD SUB-ASSEMBLY.

<sup>△</sup> THIS TOOL USED FOR DUAL CRIMP APPLICATION.

5. THE HAND TOOL INSTRUCTION SHEET, ALSO KNOWN AS AN "IS", FOR MOST CERTI-CRIMP II TOOLS USE IS 408-8547. IF THE TOOL HAS A FLIP LOCATOR USE IS 408-10414.



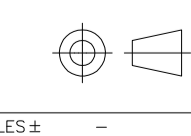

2. AMP, CERTI-CRIMP, and DYNAMIC are trademarks.

## CERTI-CRIMP II DATA SHEET

DIMENSIONS: mm 	TOLERANCES UNLESS OTHERWISE SPECIFIED: 0 PLC ± - 1 PLC ± - 2 PLC ± - 3 PLC ± - 4 PLC ± -	DWN: M. YOUNGER 21FEB2012 CHK: B.A. WOLFE 22FEB2012 APVD: B.A. WOLFE 22FEB2012 NAME: B.A. WOLFE	MATERIAL: - HEAT TREAT: -  TE Connectivity
SCALE: - SIZE: A1 DRAWING NO: 1583006 SHEET: 1 of 2 REV: A5		CERTI-CRIMP TOOL DATA SHEET DYNAMIC SERIES CONNECTORS	

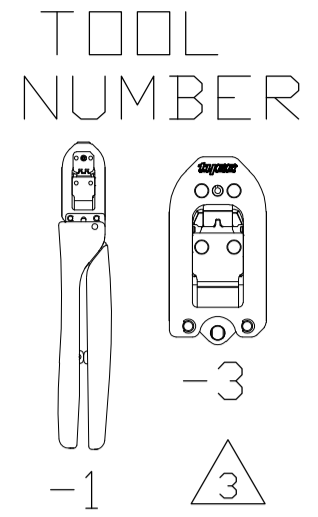
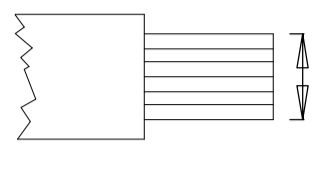
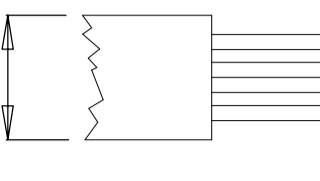
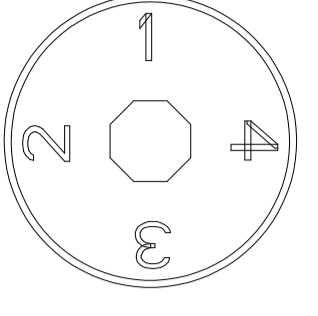
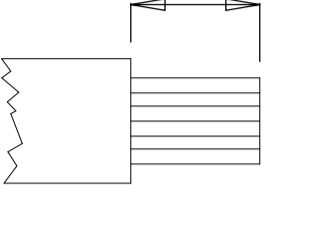
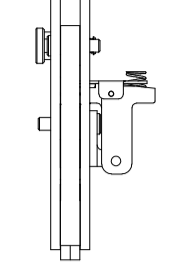
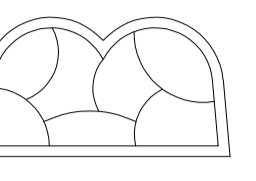
LOC: A  
 DIST: 00

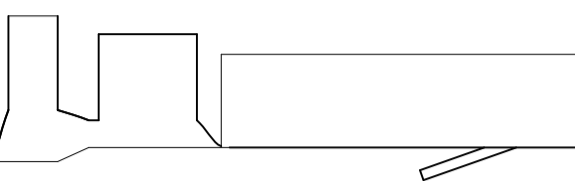
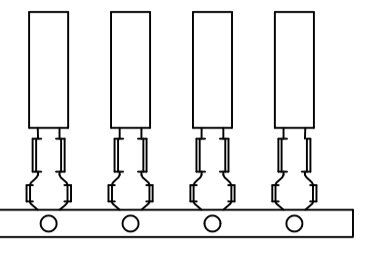
DIMENSIONING AND TOLERANCING PER ASME Y14.5M (ISO STANDARDS). THIS DRAWING IS A CONTROLLED DOCUMENT. P/N 1583006

TOOL NUMBER 	WIRE SIZE mm <sup>2</sup> [AWG] 	INSULATION DIAMETER mm [in.] 	INSULATION ADJUST 	STRIP LENGTH mm [in.] 	FLIP LOCATOR 	CRIMP HEIGHT mm [in.] 	CONTACT PART NUMBERS 		CONTACT DESCRIPTION	APPLICATION SPECIFICATION
							LOOSE PIECE 	STRIP FORM 		
2119141-1 2119141-3	0.09-0.12 [28-26] 0.20-0.38 [24-22]	1.08-1.50 [.042-.059]	NO	1.7-2.3 [.067-.091]	YES	0.59-0.69 [.023-.027] 0.69-0.79 [.27-.031]	1827587-2 1871743-1 1903116-2 1903124-1	-	DYNAMIC Series D 1000 M TYPE CONTACTS	114-5377
2119142-1 2119142-3	0.37-0.53 [22-20] 0.87 [18]	1.40 [.056] 2.20 [.087]	NO	1.7-2.3 [.067-.091]	YES	0.80-0.90 [.031-.035] 1.10-1.20 [.043-.047]	1827589-2 1871745-1 1903118-2 1903126-1	-	DYNAMIC Series D 1000 2L TYPE CONTACTS	114-5377
2119143-1 2119143-3	0.09-0.12 [28-26] 0.20-0.38 [24-22]	1.20-1.90 [.047-.075]	NO	1.7-2.3 [.067-.091]	YES	0.59-0.69 [.023-.027] 0.69-0.79 [.027-.031]	1827588-2 1871744-1 1903117-2 1903125-1	-	DYNAMIC Series D 1000 L TYPE CONTACTS	114-5377
2119144-1 2119144-3	0.05 [30] 0.09 [.28]	0.60-1.30 [.024-.051]	NO	1.7-2.3 [.067-.091]	YES	0.49-0.59 [.019-.023] 0.52-0.62 [.020-.024]	1827586-2 1903115-2	-	DYNAMIC Series D 1000 S TYPE CONTACTS	114-5377
2119821-1 2119821-3 	DUAL WIRE APPLICATION 0.8 [18]	-	NO	2.85-3.15 [.112-.124]	YES	1.04-1.10 [.041-.043]	-	293389-1 293390-1	DYNAMIC Series D 1000 M TYPE CONTACTS (DUAL WIRE APPLICATION)	114-21150

 LIST OF APPLIED CONTACT PART NUMBERS MAY NOT BE COMPLETE AND IS SUBJECT TO CHANGE. FOR CURRENT INFORMATION ON TERMINAL PART NUMBERS, CONTACT THE TOOLING ASSISTANCE CENTER : 1-800-722-1111.

2. AMP, CERTI-CRIMP, and DYNAMIC are trademarks.

 -1 IS A CERTICRIMP II HAND TOOL ASSEMBLY.  
-3 IS A CERTICRIMP II HEAD SUB-ASSEMBLY.

 THIS TOOL USED FOR DUAL CRIMP APPLICATION.

5. THE HAND TOOL INSTRUCTION SHEET, ALSO KNOWN AS AN "IS", FOR MOST CERTI-CRIMP II TOOLS USE IS 408-8547. IF THE TOOL HAS A FLIP LOCATOR USE IS 408-10414.

## CERTI-CRIMP II DATA SHEET

DWN M. YOUNGER	21FEB2012	MATERIAL -	HEAT TREAT -
CHK B.A.WOLFE	22FEB2012	 TE Connectivity	
APVD B.A. WOLFE	22FEB2012		
NAME CERTI-CRIMP TOOL DATA SHEET DYNAMIC SERIES CONNECTORS			
SCALE -	SIZE A1	DRAWING NO 1583006	SHEET 2 of 2 REV A5

DIMENSIONS: mm	0 PLC ± .01	1 PLC ± .01	2 PLC ± .01	3 PLC ± .01	4 PLC ± .01
ANGLES: #	-				
SURFACE TEXTURE	√				

LOC  
A  
DIST  
00