



Chipsmall Limited consists of a professional team with an average of over 10 year of expertise in the distribution of electronic components. Based in Hongkong, we have already established firm and mutual-benefit business relationships with customers from,Europe,America and south Asia,supplying obsolete and hard-to-find components to meet their specific needs.

With the principle of “Quality Parts,Customers Priority,Honest Operation,and Considerate Service”,our business mainly focus on the distribution of electronic components. Line cards we deal with include Microchip,ALPS,ROHM,Xilinx,Pulse,ON,Everlight and Freescale. Main products comprise IC,Modules,Potentiometer,IC Socket,Relay,Connector.Our parts cover such applications as commercial,industrial, and automotives areas.

We are looking forward to setting up business relationship with you and hope to provide you with the best service and solution. Let us make a better world for our industry!



Contact us

Tel: +86-755-8981 8866 Fax: +86-755-8427 6832

Email & Skype: info@chipsmall.com Web: www.chipsmall.com

Address: A1208, Overseas Decoration Building, #122 Zhenhua RD., Futian, Shenzhen, China



Description

One, two and three pole thermal-magnetic circuit breakers with trip-free mechanism and toggle actuation (S-type TM CBE to EN 60934/IEC 934). Featuring a combi-foot design for both symmetric and asymmetric rail mounting. Available with auxiliary contact (1 x N/O or 1 x N/C) for status signalling. Two and three pole models are internally linked to ensure that both/all poles trip in the event of an overload on one pole, even if the actuator is held in the ON position. This CBE can be supplied in current ratings up to 32 A with a choice of characteristic curves. All screw terminals are recessed for safety. Approved to CBE standard EN 60934 (IEC 60934).

Typical applications

Process control equipment, robotics, machine tool control, communications systems, instrumentation.

Preferred types

Preferred types	Standard current ratings (A)										
	0.5	1	2	3	4	5	6	8	10	16	20
1-pole	x	x	x	x	x	x	x	x	x	x	x
2210-T210-K0M1-H121-	x	x	x	x	x	x	x	x	x	x	x
2-pole	0.5	1	2	3	4	5	6	8	10	16	20
2210-T220-K0M1-H221-			x		x		x		x	x	x

Ordering information

Type No.	2210	single and multipole thermal-magnetic circuit breaker
Mounting	T	rail mounting
Actuator design	2	toggle
Number of poles	1	single pole protected
	2	2-pole protected
	3	3-pole protected
Accessories	0	without accessories
Terminal design (main contacts)	K0	screw terminals
Characteristic curve	F1	fast acting: therm. 1.01-1.4xI _N ; magn. 2-4xI _N DC (DC only)
	F2	fast acting: therm. 1.01-1.4xI _N ; magn. 3.5-6.5xI _N AC/4.5-8.5xI _N DC
	M1	standard delay: therm. 1.01-1.4xI _N ; magn. 6-12xI _N AC, 7.8-15.6xI _N DC
	T1	delayed: therm. 1.01-1.4xI _N ; magn. 10-20xI _N AC
Auxiliary contact design	H	without intermediate position
Auxiliary contacts	1	with auxiliary contacts
	2	auxiliary contacts on pole 1 only (multipole devices)
Auxiliary contact function (see diagrams)	2	1 N/O contact
	3	1 N/C contact
Auxiliary contact - terminal design	1	screw terminals
Current ratings	0.1...32 A	
Ordering example	2210 - T 2 1 0 - K0 M1 - H 1 2 1 - 10 A	

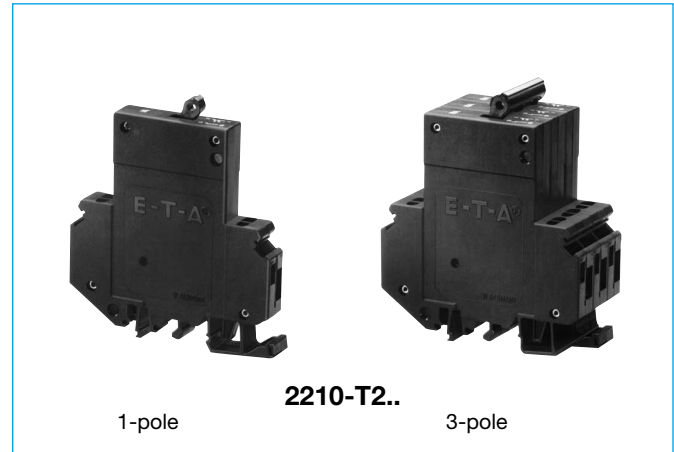

Technical data

For further details please see chapter: Technical Information		
Voltage rating	AC 250 V; 3 AC 433 V (50/60 Hz); DC 65 V (UL: AC 277/480 V; DC 65 V)	
Current rating range	0.1...32 A for curves M1, T1 0.1...16 A for curves F1, F2	
Auxiliary circuit	1 A, AC 240 V / DC 65 V, resistive (min. 10 V / 10 mA)	
Typical life	3 AC 433 V; AC 250 V: 0.1...25 A 10,000 operations at 1 x I _N , inductive DC 65 V: 0.1...32 A 10,000 operations at 1 x I _N , inductive 32 A 3 AC 433 V; AC 250 V: 6,000 operations at 1 x I _N , resistive	
Ambient temperature	-30...+60 °C (-22...+140 °F) T 60	
Insulation co-ordination (IEC 60664 and 60664 A)	rated impulse withstand voltage 2.5 kV	pollution degree 2 reinforced insulation in operating area
Dielectric strength (IEC 60664 and 60664A)	test voltage	operating area
	AC 3,000 V	AC 3,000 V
	AC 3,000 V	AC 1,500 V
Insulation resistance	> 100 MΩ (DC 500 V)	
Interrupting capacity I _{cn}	0.1...5 A	400 A
	6...32 A	800 A
curves F1, F2, M1, T1:	0.1...16 A	2,500 A (at DC 32 V)
Interrupting capacity (UL 1077)		
I _N	0.1...16 A	20...25 A
AC 277 V 1-pole	5,000 A	2,000 A
AC 277/480 V 2-/3-pole	5,000 A	2,000 A
DC 65 V	2,000 A	2,000 A
Degree of protection (IEC 60529/DIN 40050)	operating area IP30 terminal area IP20	
Vibration	curves F1, F2: 3 g (57-500 Hz), ± 0.23 mm (10-57 Hz)	curves M1, T1: 5 g (57-500 Hz), ± 0.38 mm (10-57 Hz)
	to IEC 60068-2-6, test Fc 10 frequency cycles/axis	
Shock	curves F1, F2: 25 g (11 ms), directions 1, 2, 3, 4, 5 10 g (11 ms), direction 6	curves M1, T1: 25 g (11 ms), directions 1, 2, 3, 4, 5 20 g (11 ms), direction 6
	to IEC 60068-2-27, test Ea	
Corrosion	96 hours at 5 % salt mist to IEC 60068-2-11, test Ka	
Humidity	240 hours at 95 % RH to IEC 60068-2-78, test Cab	
Mass	approx. 60 g per pole	

Standard current ratings and typical internal resistance values

Current rating (A)	Internal resistance (Ω)			
	F1	F2	M1	T1
	fast acting for DC only	fast acting delay for AC + DC	standard for AC+DC	delayed low resistance for AC only
0.1	162	162	92	81
0.2	39.3	39.3	26.1	24.2
0.3	17.5	17.5	11.6	10.4
0.4	9.2	9.2	6.6	6.0
0.5	6.8	6.8	4.1	3.9
0.6	4.2	4.2	3	2.7
0.8	2.8	2.8	1.65	1.53
1	1.6	1.6	1.10	0.98
1.5	0.78	0.78	0.47	0.42
2	0.42	0.42	0.28	0.24
2.5	0.26	0.26	0.183	0.17
3	0.18	0.18	0.124	0.12
4	0.12	0.12	0.077	0.073
5	0.092	0.092	0.063	0.055
6	0.054	0.054	0.045	0.039
8	0.025	0.025	≤ 0.02	≤ 0.02
10	0.022	0.02	≤ 0.02	≤ 0.02
12	≤ 0.02	≤ 0.02	≤ 0.02	≤ 0.02
16	≤ 0.02	≤ 0.02	≤ 0.02	≤ 0.02
20	-	-	≤ 0.02	≤ 0.02
25	-	-	≤ 0.02	≤ 0.02
32	-	-	≤ 0.02	≤ 0.02

Approvals

Authority	Standard	Rated voltage	Current ratings
VDE	IEC/EN 60934	3 AC 433 V AC 250 V DC 65 V	0.1 A...32 A 0.1 A...32 A 0.1 A...32 A
UL	UL 1077	AC 277/480 V AC 277 V DC 65 V	0.1 A...32 A 0.1 A...32 A 0.1 A...32 A
CSA	C22.2 No 235	AC 277/480 V AC 277 V DC 65 V	0.1 A...32 A 0.1 A...32 A 0.1 A...32 A
CQC	GB 17701	AC 250/433 V AC 250 V DC 65 V	0.1 A...32 A 0.1 A...32 A 0.1 A...32 A
DNV GL	IEC 60934, DNVGL- CG 0339	3 AC 433 V AC 250 V DC 65 V	0.1 A...32 A 0.1 A...32 A 0.1 A...32 A
KTL	KC60934	AC 250 V, 1-pole AC 433 V, 2-pole	0.1 A...16 A 0.1 A...16 A

Dimensions

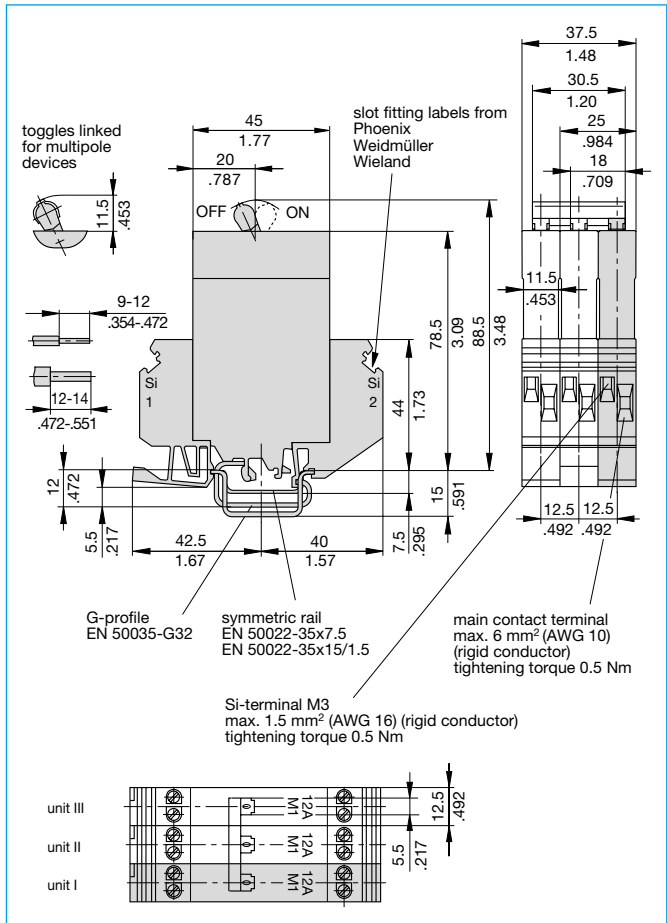

Installation drawing

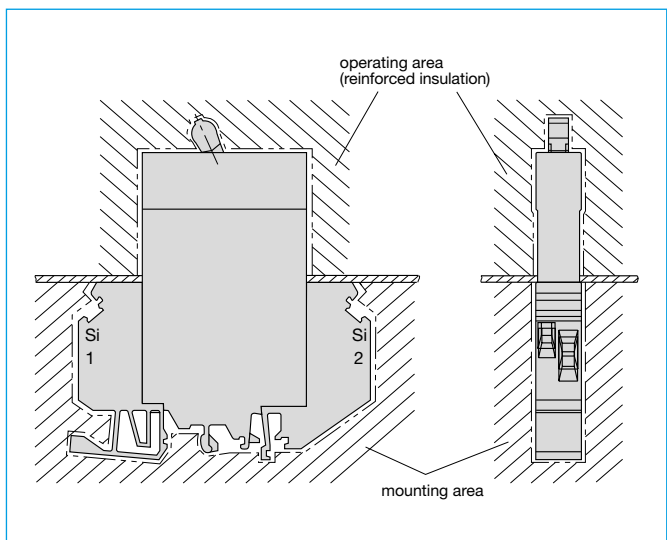

This is a metric design and millimeter dimensions take precedence (mm/inch)

Internal connection diagrams

...-H131-...

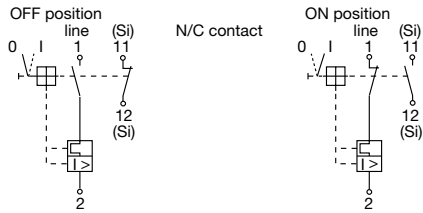

...-H121-...

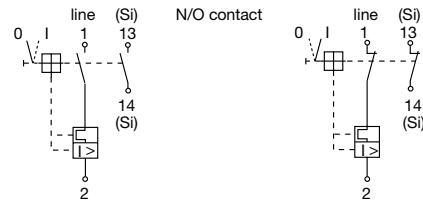

Shock directions

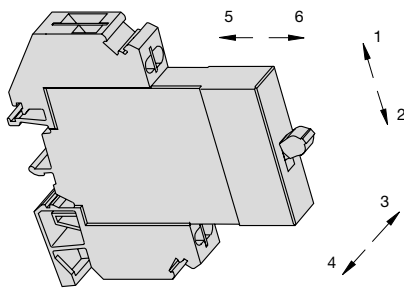

Typical time/current characteristics

-F1 0.1...16 A DC only

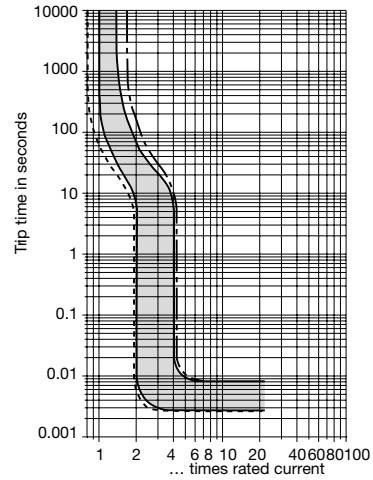

-F2 0.1...7.5 A AC/ DC¹⁾

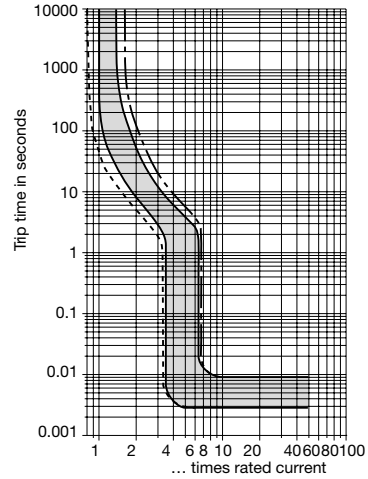

-F2 8...16 A AC/ DC¹⁾

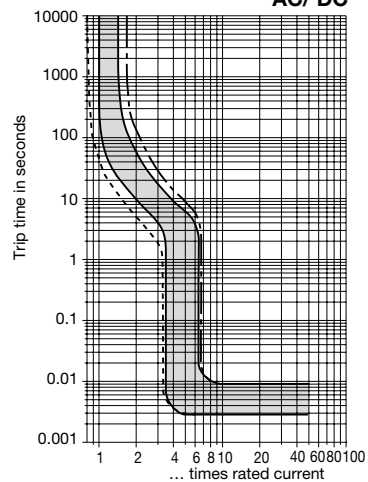

--- +60 °C / +140 °F ——— +23 °C / +73.4 °F - - - -30 °C / -22 °F

¹⁾Magnetic tripping currents are increased by 30% on DC supplies.

1

Typical time/current characteristics

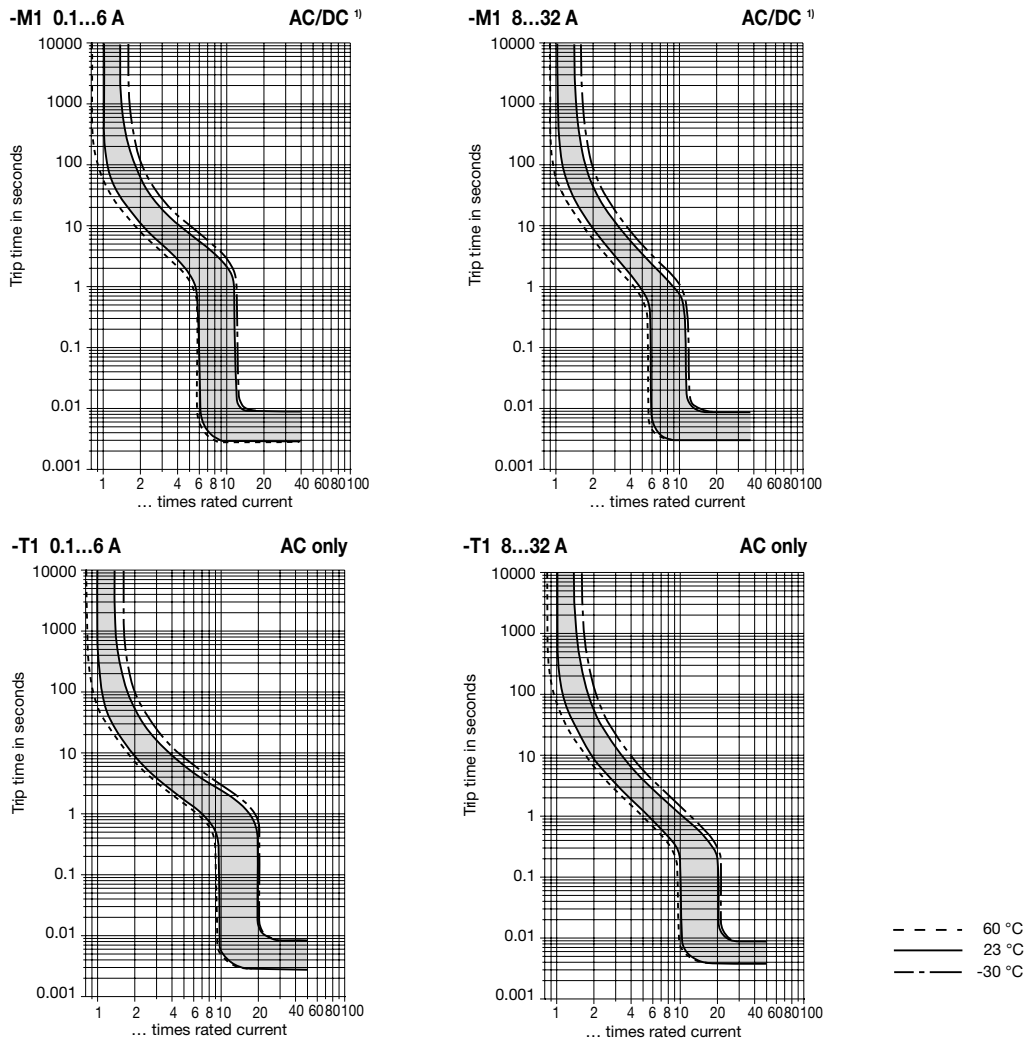

The time/current characteristic curve depends on the ambient temperature prevailing. In order to eliminate nuisance tripping, please multiply the circuit breaker current ratings by the derating factor shown below. See also section Technical information.

Ambient °F	-22	-4	+14	+32	+73.4	+86	+104	+122	+140
temp. °C	-30	-20	-10	0	+23	+30	+40	+50	+60
Derating factor	0.76	0.79	0.83	0.88	1	1.04	1.11	1.19	1.29

Multi pole devices: all poles symmetrically loaded. With single pole overload, thermal tripping will be at max. $1.7 \times I_N$ with curves F1, F2 and M1.

¹⁾ Magnetic tripping currents are increased by 30 % on DC supplies (curves F2, M1).

Accessories

Connector bus links -K10

X210 589 01/ 2.5 mm², (AWG 14) (black) up to 20 A max. load
X210 589 02/ 1.5 mm², (AWG 16) (brown) up to 13 A max. load

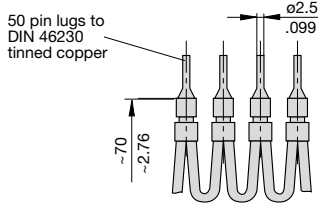

Busbar 1-pole, 90°

X 222 540 01

The one metre long busbars can be cut to suitable lengths. Plug-on caps can be fitted on the ends to provide brush contact protection.

I_{max} - busbar 100 A (40 °C)

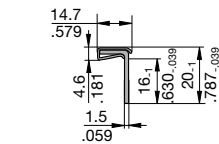
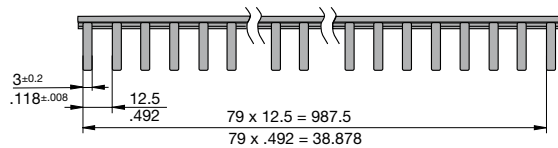

**Plug-on cap, 1-pole
Y 307 851 01**

Busbar 1-pole

Y 308 498 01

I_{max} - busbar 100 A (40 °C)

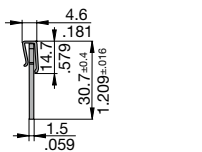
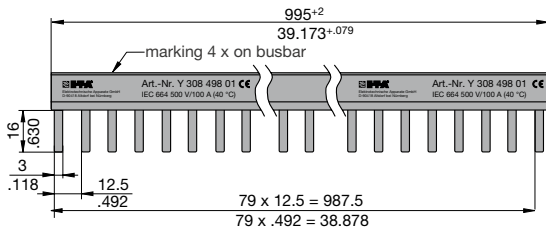

**Plug-on cap, 1-pole
Y 307 851 01**

Busbar 2-pole

Y 308 499 01

I_{max} - busbar 100 A (40 °C)

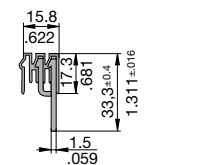
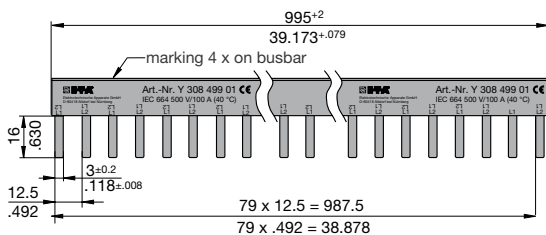

**Plug-on cap, busbar 2/3-pole
Y 308 506 01**

Busbar 3-pole

Y 308 500 01

I_{max} - busbar 100 A (40 °C)

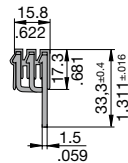
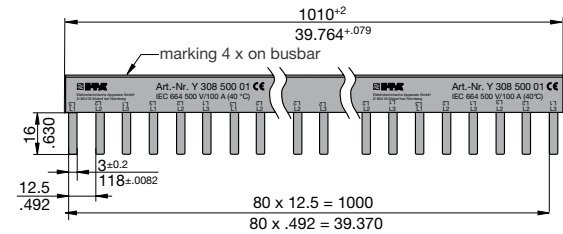

**Plug-on cap, busbar 2/3-pole
Y 308 506 01**

Supply terminal

Y 308 503 01

I_{max} 63 A with 1-pole busbar,

50 A with multipole busbar

Max. tightening torque of terminal screw 2 Nm

Max. cable cross section: 25 mm² / single strand
 16 mm² / multistrand
 with wire end ferrule

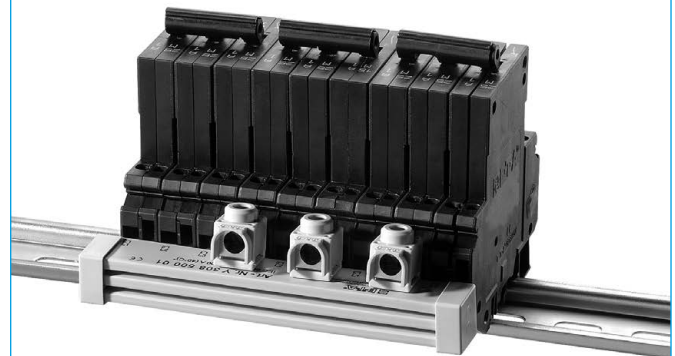
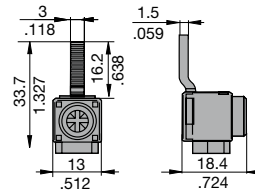

Caution:

When using multipole busbars please leave at least one pole's width between two adjacent line entry terminals.

This is a metric design and millimeter dimensions take precedence (mm / inch)

All dimensions without tolerances are for reference only. In the interest of improved design, performance and cost effectiveness the right to make changes in these specifications without notice is reserved. Product markings may not be exactly as the ordering codes. Errors and omissions excepted.

1

