



Chipsmall Limited consists of a professional team with an average of over 10 year of expertise in the distribution of electronic components. Based in Hongkong, we have already established firm and mutual-benefit business relationships with customers from,Europe,America and south Asia,supplying obsolete and hard-to-find components to meet their specific needs.

With the principle of “Quality Parts,Customers Priority,Honest Operation,and Considerate Service”,our business mainly focus on the distribution of electronic components. Line cards we deal with include Microchip,ALPS,ROHM,Xilinx,Pulse,ON,Everlight and Freescale. Main products comprise IC,Modules,Potentiometer,IC Socket,Relay,Connector.Our parts cover such applications as commercial,industrial, and automotives areas.

We are looking forward to setting up business relationship with you and hope to provide you with the best service and solution. Let us make a better world for our industry!



## Contact us

Tel: +86-755-8981 8866 Fax: +86-755-8427 6832

Email & Skype: info@chipsmall.com Web: www.chipsmall.com

Address: A1208, Overseas Decoration Building, #122 Zhenhua RD., Futian, Shenzhen, China



### 7.3 x 4.3mm Compact Tactile Switch

#### Features

##### Optimized Mechanical Features

- Surface mount terminal configuration
- Compatible with IR reflow and manual soldering

##### Optimized Contact System

- Excellent tactile feedback

##### Materials

- Silver coated terminals for better solderability
- High temperature materials (UL94V-0)
- RoHS compliant

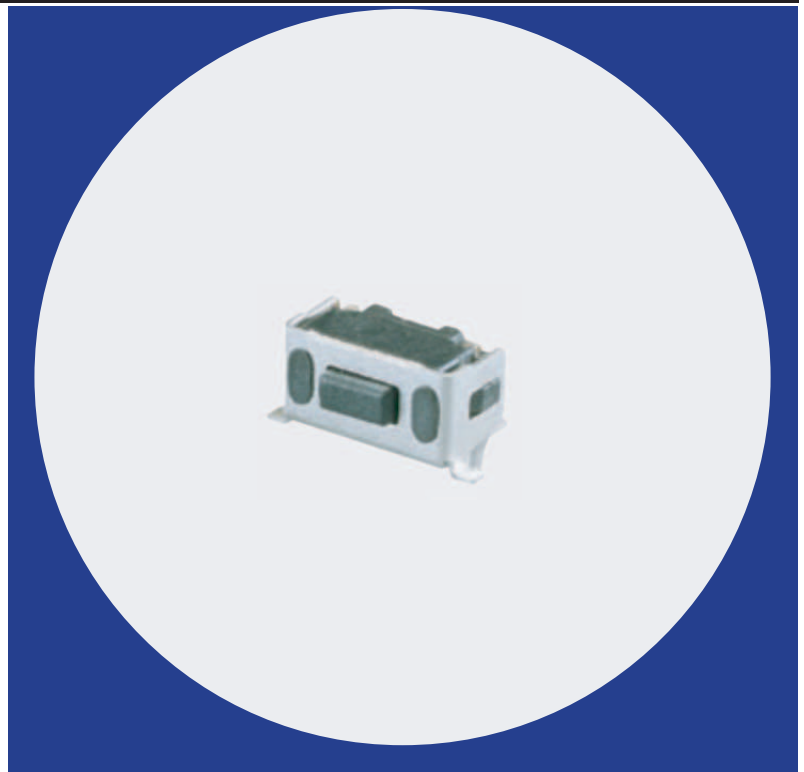

## Electrical and Mechanical Specifications

#### Switch Contact Resistance

500 milliohms maximum

#### Insulation Resistance

100 Megohms minimum between terminals

#### Maximum Rating

50mA, 12 VDC

#### Dielectric Strength

250 VAC for 1 minute between adjacent terminals

#### Operating Force

180gf

#### Travel

0.15, 0.25 mm

#### Operating Temperature

- 40°C to +85°C

#### Storage Temperature

- 40°C to +85°C

#### Push Strength

3 Kgf maximum

#### Actuation Life

Travel 0.15mm: 100,000 cycles

Travel 0.25mm: 50,000 cycles

#### Allowable Solder Time

IR Reflow: Up to 5 seconds at 260°C.

Manual soldering: Up to 3 seconds at 350°C

#### Packaging

Standard: Tape and reel packaging with 330mm diameter reel and 16mm wide plastic tape

## CTS SERIES 225AJ1...R(S)G - Surface Mount Type1, With Ground Terminal

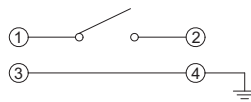
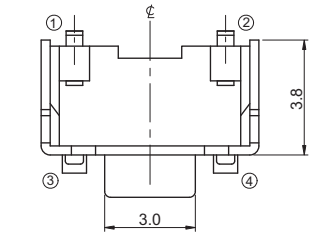

**CIRCUIT DIAGRAM**

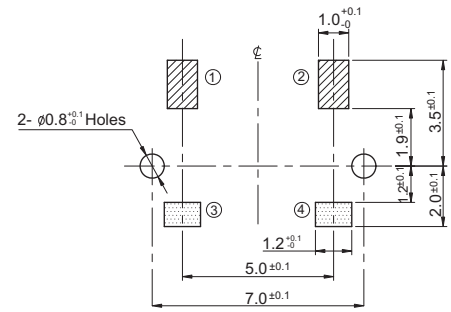

**PCB LAYOUT**

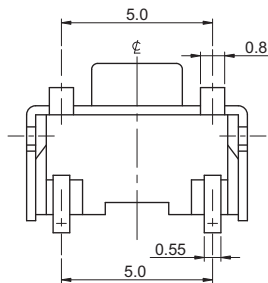
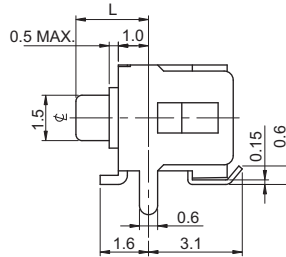
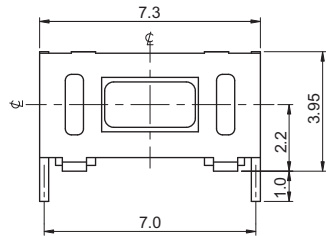

DIMENSION : mm  
STANDARD TOLERANCE :  
X (1 PLACE) : ±0.2

## CTS SERIES 225AJ2...R(S)G - Surface Mount Type2, With Ground Terminal

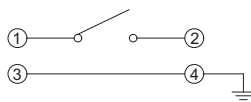
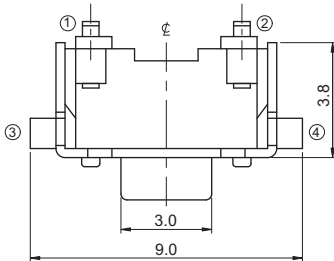

**CIRCUIT DIAGRAM**

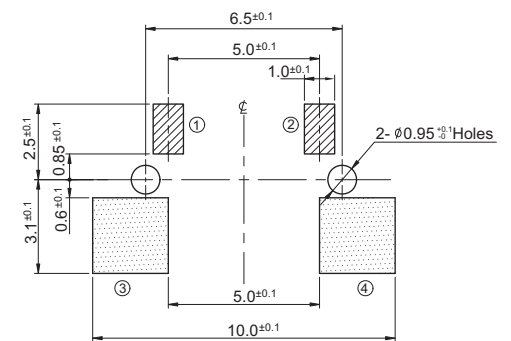

**PCB LAYOUT**

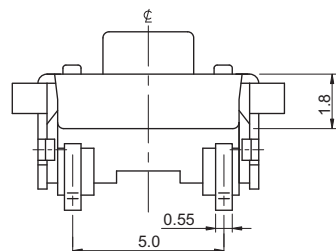
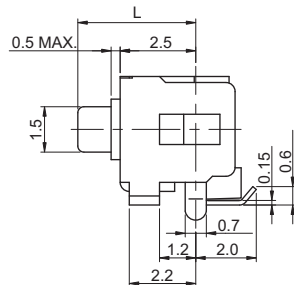
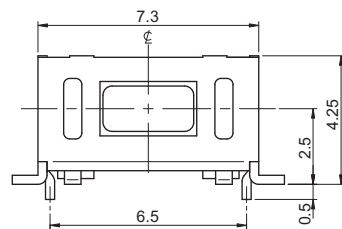

DIMENSION : mm  
STANDARD TOLERANCE :  
X (1 PLACE) : ±0.2

# Ordering Information

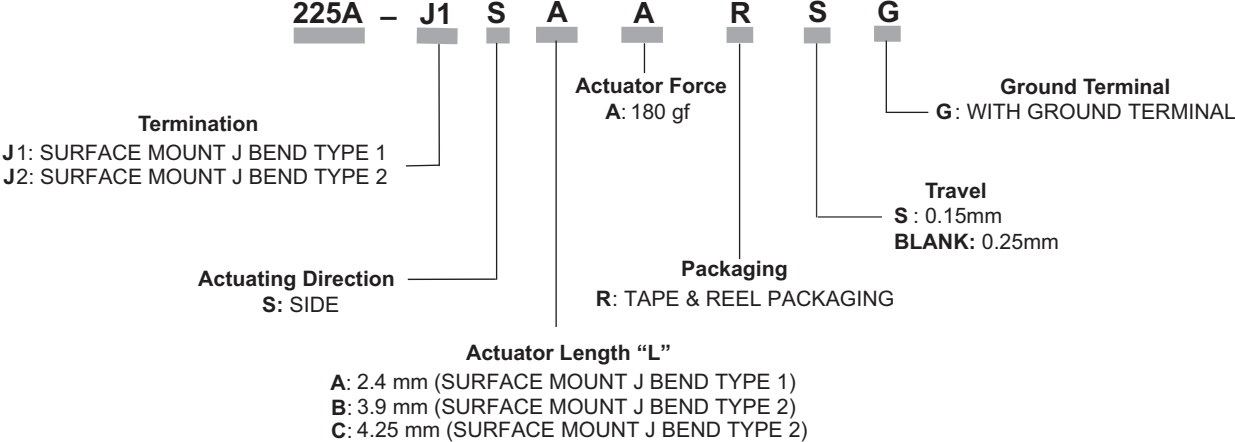

**Note:**  
 Consult CTS for other common features not listed.