



Chipsmall Limited consists of a professional team with an average of over 10 year of expertise in the distribution of electronic components. Based in Hongkong, we have already established firm and mutual-benefit business relationships with customers from,Europe,America and south Asia,supplying obsolete and hard-to-find components to meet their specific needs.

With the principle of “Quality Parts,Customers Priority,Honest Operation,and Considerate Service”,our business mainly focus on the distribution of electronic components. Line cards we deal with include Microchip,ALPS,ROHM,Xilinx,Pulse,ON,Everlight and Freescale. Main products comprise IC,Modules,Potentiometer,IC Socket,Relay,Connector.Our parts cover such applications as commercial,industrial, and automotives areas.

We are looking forward to setting up business relationship with you and hope to provide you with the best service and solution. Let us make a better world for our industry!



Contact us

Tel: +86-755-8981 8866 Fax: +86-755-8427 6832

Email & Skype: info@chipsmall.com Web: www.chipsmall.com

Address: A1208, Overseas Decoration Building, #122 Zhenhua RD., Futian, Shenzhen, China



4

3

2

1

THIS DRAWING IS UNPUBLISHED.

RELEASED FOR PUBLICATION

20

© COPYRIGHT 20

ALL RIGHTS RESERVED.

LOC
ES

DIST

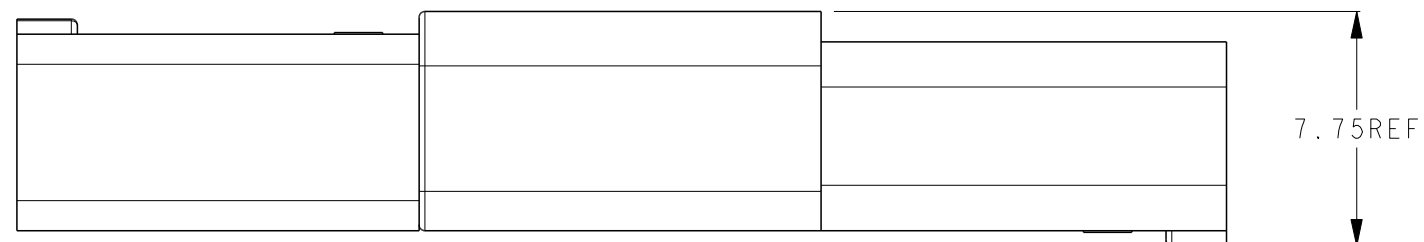
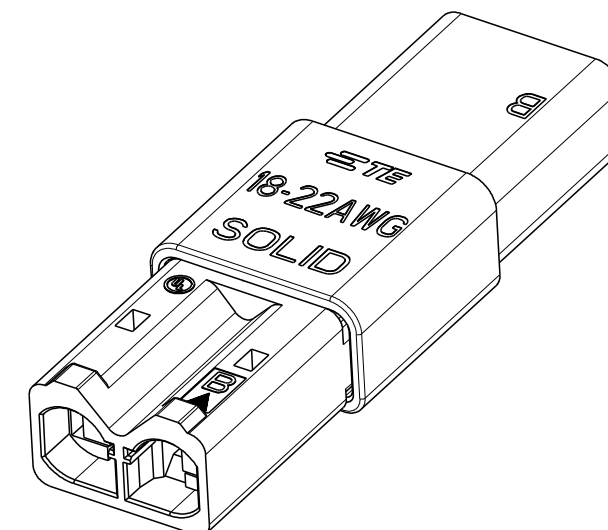
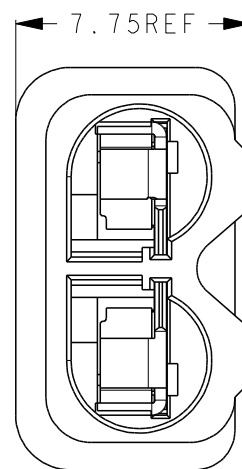
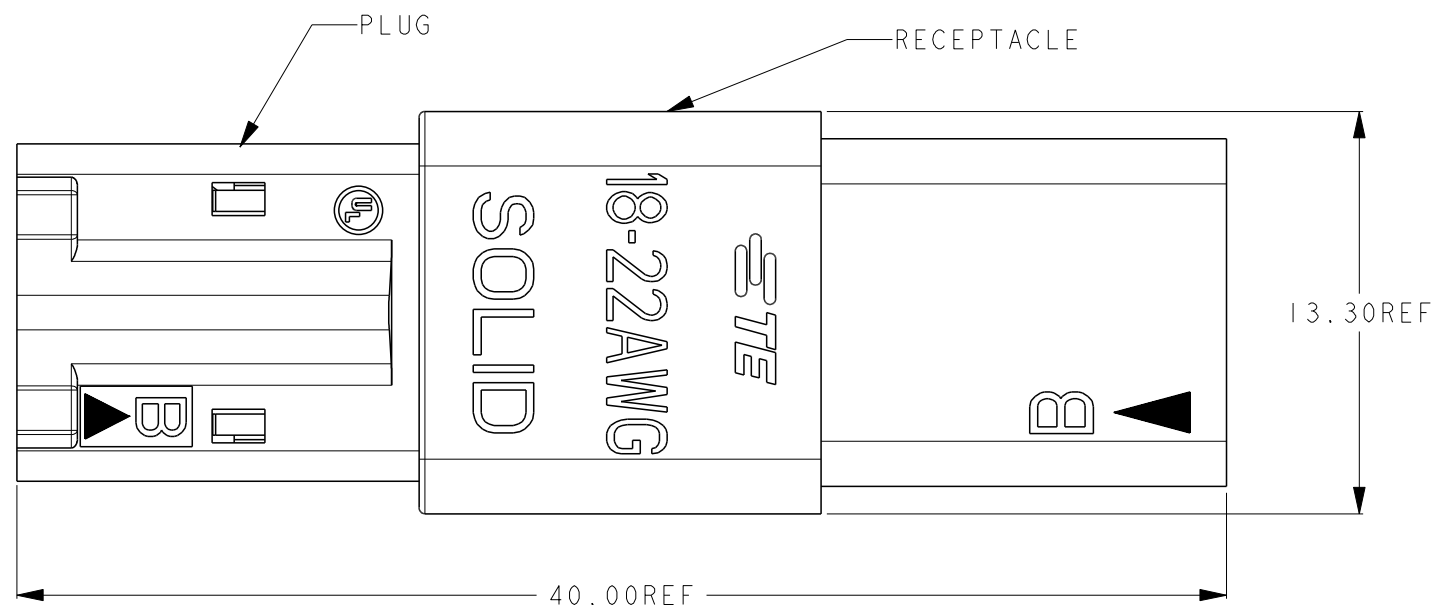

REVISIONS

P	LTR	DESCRIPTION	DATE	DWN	APVD
	A3	NOTE 5, 6	05DEC2014	M.S	X.X
	A4	MARK CHANGE	14MAY2015	M.S	X.X
	A5	ADD PN	13OCT2015	M.S	X.X
	B	ECR-16-007582	01JUN2016	M.S	X.X



PART NUMBER	PLUG	RECEPTACLE	PART COLOR
2271203-1	2271180-1	2271183-1	ORANGE
2271203-2	2271180-2	2271183-2	BLACK
2271203-3	2271180-3	2271183-3	WHITE (NATURAL)

- NOTES:
- 1 MATED CONNECTOR PART NUMBER:SEE TABLE.
 - 2 MATERIAL
 - 3 TERMINAL: COPPER ALLOY.
 - 4 HOUSING : NYLON, UL 94-V0.COLOR: ORANGE.
 - 5 FINISH
 - 6 TERMINAL : TIN PLATING OVERALL.
 - 7 PACKAGING: PLASTIC BAG.
 - 8 APPLICABLE WIRE: AWG18-22 SOLID OR TIN DIPPED STRANDED. (16 STRANDS MAX. FOR 18 AWG, 7 STRANDS MAX FOR 20-22 AWG. SEE RELATED APPLICATION SPECIFICATION AND PRODUCT SPECIFICATION)
 - 9 STRIP LENGTH:9.0-9.6mm.
 - 10 PRODUCT COMPLIES TO UL 2459 REQUIREMENT AND QUALIFIED: ZMNA.E308110 ; ZMNA7.E308110

THIS DRAWING IS A CONTROLLED DOCUMENT.		DWN	SHI MING	18MAY2014	 TE Connectivity	NAME	2 PIN WIRE TO WIRE CONNECTOR					
DIMENSIONS: mm		CHK	XU XIANG	18MAY2014			PRODUCT SPEC	APPLICATION SPEC	SIZE	CAGE CODE	DRAWING NO	RESTRICTED TO
		APVD	XU XIANG	18MAY2014					108-137020	114-137020	A300779	C=2271203
TOLERANCES UNLESS OTHERWISE SPECIFIED: ±0.50		MATERIAL		FINISH	WEIGHT	CUSTOMER DRAWING		SCALE	SHEET	OF	REV	
0-PLC ± 1-PLC ± 2-PLC ± 3-PLC ± 4-PLC ± ANGLES ±5°					3.56g			4:1	1	2	B	

4

3

2

1

THIS DRAWING IS UNPUBLISHED.

RELEASED FOR PUBLICATION

20

© COPYRIGHT 20

ALL RIGHTS RESERVED.

LOC	DIST	REVISIONS					
		P	LTR	DESCRIPTION	DATE	DWN	APVD
ES							

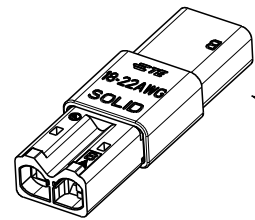

2271203-X

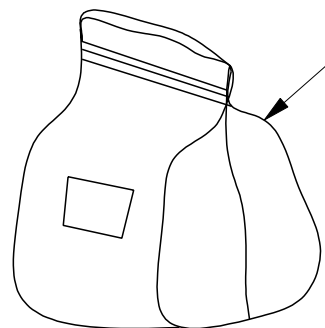

PLASTIC BAG

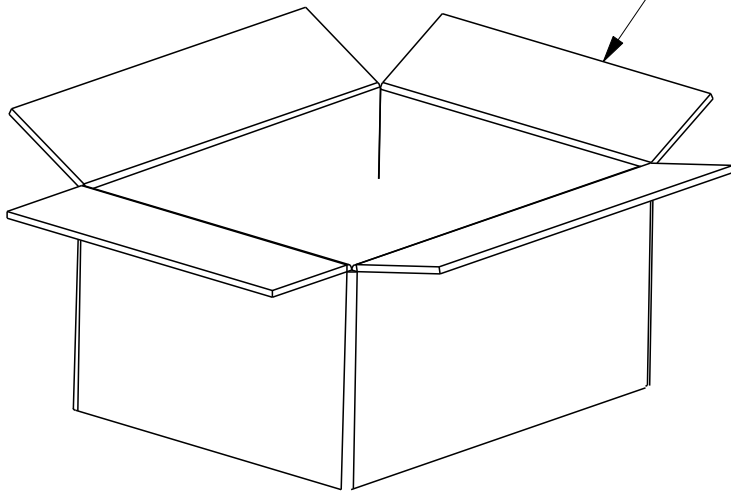

CARTON

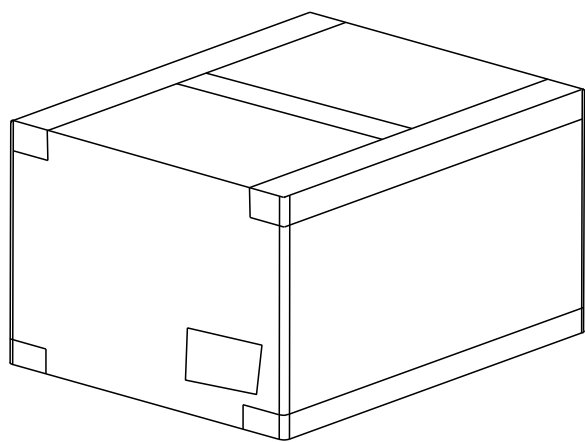

NOTE:
1. PACKAGING QUANTITY: SEE TABLE.

PAIRS PER BAG	BAGS PER CARTON	PAIRS PER CARTON
250 PCS	8	2000

THIS DRAWING IS A CONTROLLED DOCUMENT.

DIMENSIONS:	TOLERANCES UNLESS OTHERWISE SPECIFIED:
mm	
	0 PLC ±
	1 PLC ±10
	2 PLC ±5.0
	3 PLC ±
	4 PLC ±
	ANGLES ±5°
MATERIAL	FINISH
-	-

DWN	18MAY2014
CHK	SHI MING
	18MAY2014
APVD	XU XIANG
	18MAY2014
PRODUCT SPEC	
APPLICATION SPEC	
WEIGHT	-
CUSTOMER DRAWING	



NAME				2 PIN WIRE TO WIRE CONNECTOR			
SIZE	CAGE CODE	DRAWING NO	RESTRICTED TO				
A300779	C=2271203		-				
SCALE 4:1			SHEET 2 OF 2		REV B		

D

C

B

A