



Chipsmall Limited consists of a professional team with an average of over 10 year of expertise in the distribution of electronic components. Based in Hongkong, we have already established firm and mutual-benefit business relationships with customers from,Europe,America and south Asia,supplying obsolete and hard-to-find components to meet their specific needs.

With the principle of “Quality Parts,Customers Priority,Honest Operation,and Considerate Service”,our business mainly focus on the distribution of electronic components. Line cards we deal with include Microchip,ALPS,ROHM,Xilinx,Pulse,ON,Everlight and Freescale. Main products comprise IC,Modules,Potentiometer,IC Socket,Relay,Connector.Our parts cover such applications as commercial,industrial, and automotives areas.

We are looking forward to setting up business relationship with you and hope to provide you with the best service and solution. Let us make a better world for our industry!



Contact us

Tel: +86-755-8981 8866 Fax: +86-755-8427 6832

Email & Skype: info@chipsmall.com Web: www.chipsmall.com

Address: A1208, Overseas Decoration Building, #122 Zhenhua RD., Futian, Shenzhen, China



4

3

2

1

THIS DRAWING IS UNPUBLISHED. RELEASED FOR PUBLICATION
 © COPYRIGHT - By - ALL RIGHTS RESERVED.

LOC	DIST	REVISIONS			
P	LTR	DESCRIPTION	DATE	DWN	APVD
	A	INITIAL RELEASE	16JAN2014	GSK	BvH

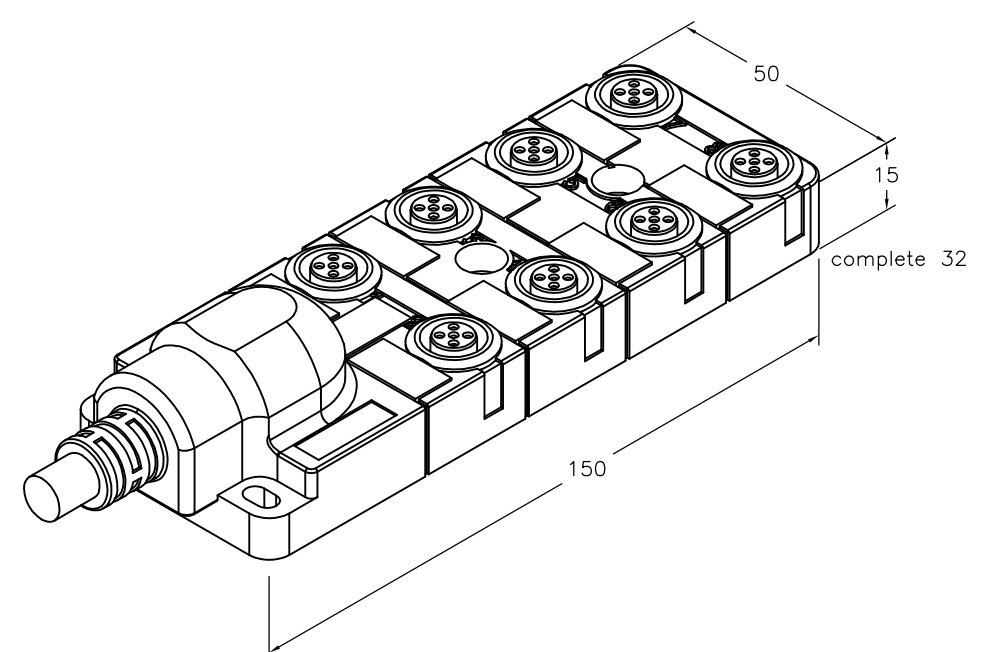
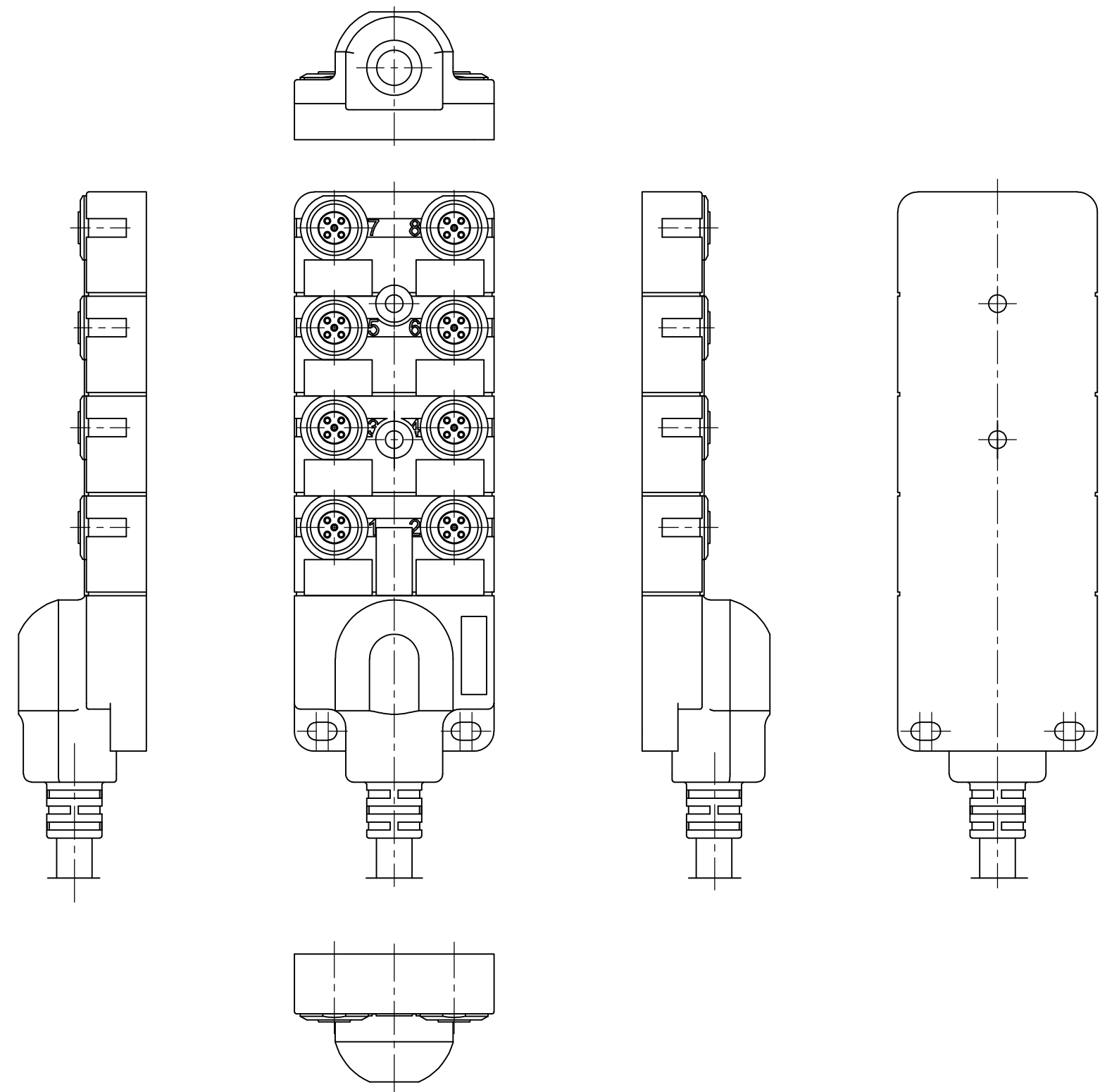

PUR cable 20m	1-2273163-5
PUR cable 15m	1-2273163-4
PUR cable 10m	1-2273163-3
PUR cable 5m	1-2273163-2
PUR cable 3m	1-2273163-1
PUR/PVC cable 20m	2273163-5
PUR/PVC cable 15m	2273163-4
PUR/PVC cable 10m	2273163-3
PUR/PVC cable 5m	2273163-2
PUR/PVC cable 3m	2273163-1
DESCRIPTION	TE PN

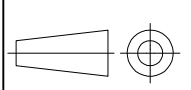
THIS DRAWING IS A CONTROLLED DOCUMENT.		DWN 16JAN2014 SATHISH KUMAR .G	 TE Connectivity	
DIMENSIONS: mm		CHK 16JAN2014 B.VELDHOVEN		
TOLERANCES UNLESS OTHERWISE SPECIFIED:		APVD 16JAN2014 A.VAN ZANDVOORT	NAME DISTR BOX M12 5POS 8WAY PNP	
		PRODUCT SPEC -	-	
MATERIAL		APPLICATION SPEC -	-	
FINISH		WEIGHT -	SIZE A3	CAGE CODE 00779
		DRAWING NO C-2273163		RESTRICTED TO -
		CUSTOMER DRAWING		SCALE NTS
		SHEET 1 OF 2		REV A

THIS DRAWING IS UNPUBLISHED. RELEASED FOR PUBLICATION
 © COPYRIGHT - By - ALL RIGHTS RESERVED.

LOC	DIST	REVISIONS					
H	-	P	LTR	DESCRIPTION	DATE	DWN	APVD
		-		SEE SHEET 1	-	-	-

Contact layout

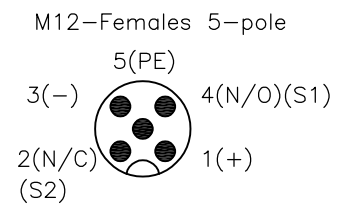

Circuit diagram

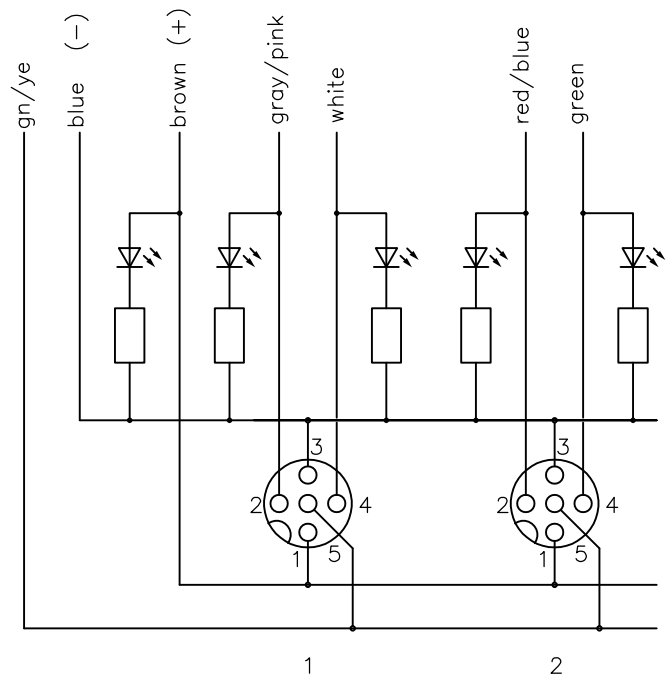

for 2 Signals per port

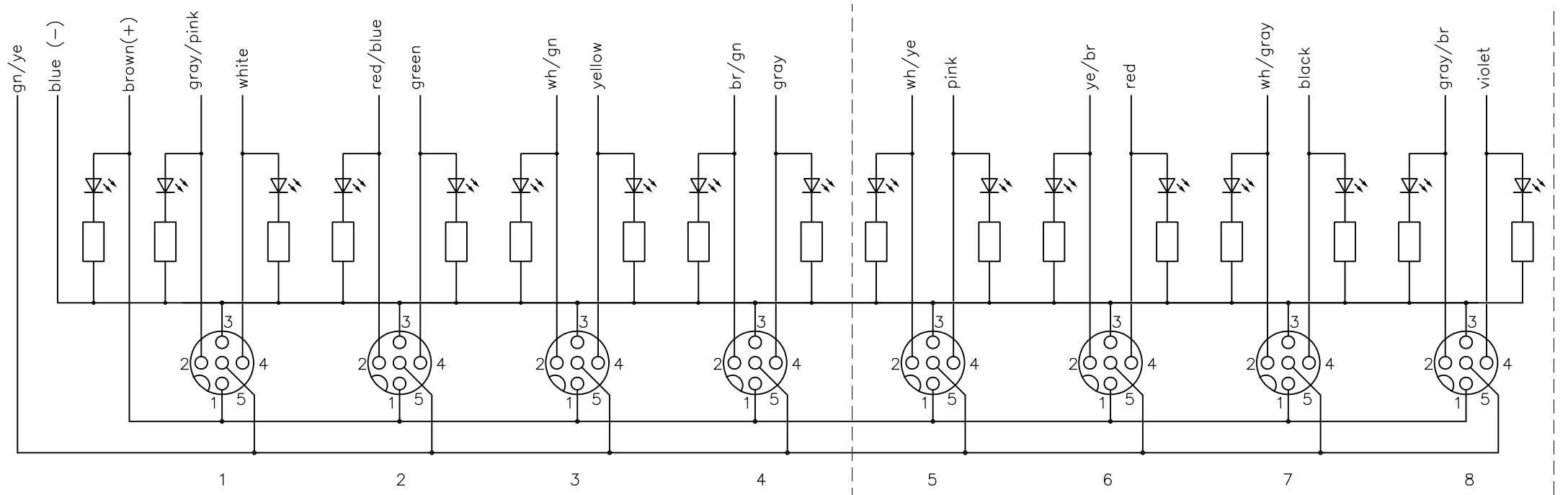

4xM12

8xM12

THIS DRAWING IS A CONTROLLED DOCUMENT.		DWN 16JAN2014 SATHISH KUMAR .G	TE Connectivity			
DIMENSIONS: mm		CHK 16JAN2014 B.VELDHOVEN				
TOLERANCES UNLESS OTHERWISE SPECIFIED:		APVD 16JAN2014 A.VAN ZANDVOORT	NAME DISTR BOX M12 5POS 8WAY PNP			
		PRODUCT SPEC	-			
0 PLC ± - 1 PLC ± - 2 PLC ± - 3 PLC ± - 4 PLC ± - ANGLES ± -		APPLICATION SPEC	-			
MATERIAL		WEIGHT	SIZE	CAGE CODE	DRAWING NO	RESTRICTED TO
-		-	A3	00779	C-2273163	-
CUSTOMER DRAWING			SCALE	SHEET	REV	
			NTS	2 OF 2	A	