



Chipsmall Limited consists of a professional team with an average of over 10 year of expertise in the distribution of electronic components. Based in Hongkong, we have already established firm and mutual-benefit business relationships with customers from,Europe,America and south Asia,supplying obsolete and hard-to-find components to meet their specific needs.

With the principle of “Quality Parts,Customers Priority,Honest Operation,and Considerate Service”,our business mainly focus on the distribution of electronic components. Line cards we deal with include Microchip,ALPS,ROHM,Xilinx,Pulse,ON,Everlight and Freescale. Main products comprise IC,Modules,Potentiometer,IC Socket,Relay,Connector.Our parts cover such applications as commercial,industrial, and automotives areas.

We are looking forward to setting up business relationship with you and hope to provide you with the best service and solution. Let us make a better world for our industry!



Contact us

Tel: +86-755-8981 8866 Fax: +86-755-8427 6832

Email & Skype: info@chipsmall.com Web: www.chipsmall.com

Address: A1208, Overseas Decoration Building, #122 Zhenhua RD., Futian, Shenzhen, China



PCB Connection Technology and Electronics Housing

1

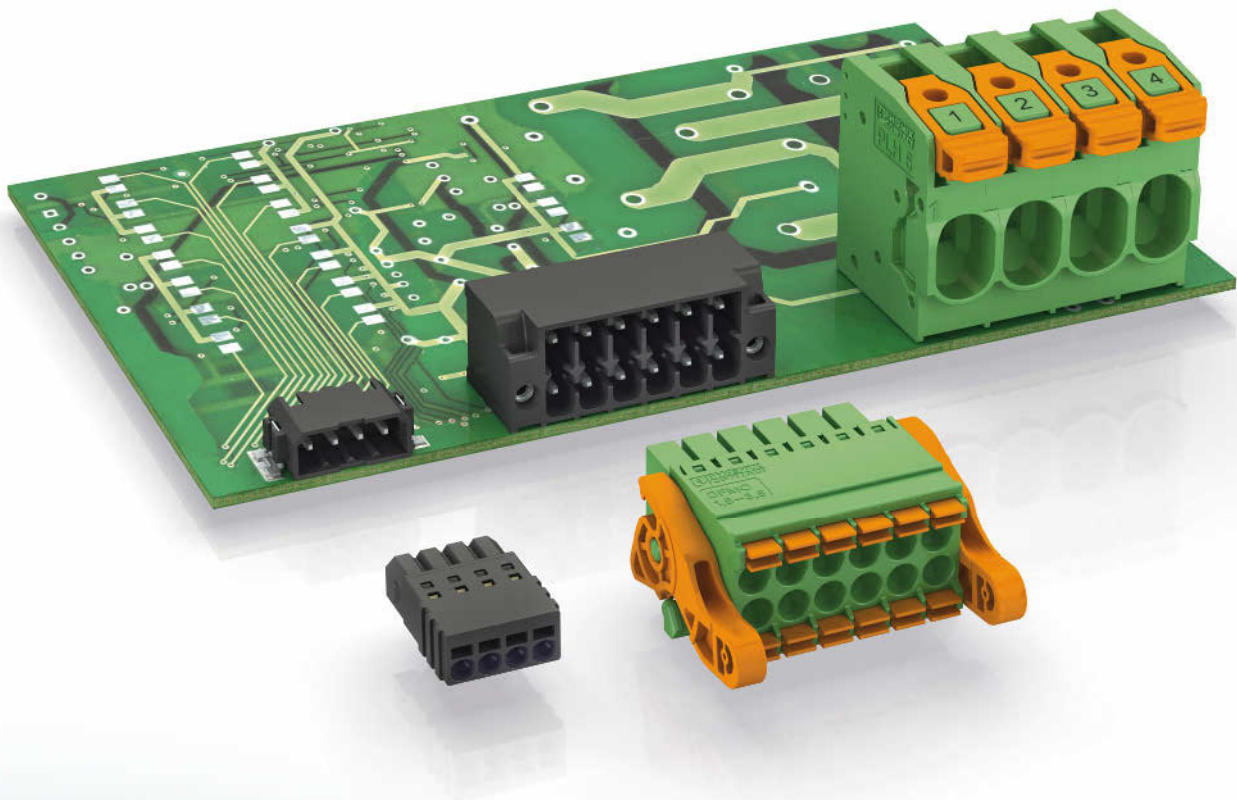



PCB connection technology and electronics housing



Connection technology for field devices

- Plug-in connectors
- Cables and connectors



Modular terminal blocks

- Modular terminal blocks



Sensor/actuator cabling and industrial plug-in connectors

- Sensor/actuator cabling
- Cables and connectors
- Plug-in connectors



Marking systems, tools, and mounting material

- Marking and labeling
- Tools
- Installation and mounting material



Surge protection and power supply units

- Lightning monitoring system
- Surge protection and interference filters
- Power supply units and UPS
- Protective devices



Interface technology and switching devices

- Electronic switching devices and motor control
- Measurement and control technology • Monitoring
- Relay modules • System cabling for controllers



Control technology, I/O systems and automation infrastructure

- Ethernet networks • Functional safety • HMIs and industrial PCs • I/O systems
- Industrial lighting and signaling • Industrial communication technology
- Fieldbus components and systems • Wireless data communication
- Process infrastructure • Software • Controllers

Table of contents

Device connection technology for signals, data, and power from Phoenix Contact			2
High density PCB terminal blocks and plug-in connectors	COMBICON HD		45
PCB terminal blocks with 2.54 to 7.62 mm pitch	COMBICON control		71
Plug-in connector systems with 2.0/2.5 and 2.54 mm pitch	COMBICON control		167
Plug-in connector systems with 3.5/3.81 and 5.08 mm pitch	COMBICON control		181
Plug-in connector systems with 5.0 to 7.62 mm pitch	COMBICON control		255
Connection technology for building and LED applications	COMBICON compact		385
PCB terminal blocks for power electronics with 5.0 to 15.0 mm pitch	COMBICON power		439
Plug-in connector systems for power electronics with 5.0 to 15.0 mm pitch	COMBICON power		481
Feed-through terminal blocks for high-current applications	COMBICON power		597
Electronics housing for industrial electronics and semi-industrial applications	HOUSING		647
Plug-in card blocks and socket strips according to DIN 41617 and IEC 60603-2/DIN 41612	COMBICON control 19 inch		773
Accessories, technical information, and index			793

COMBICON control

Connection technology for measurement and control technology and I/O modules: PCB terminal blocks and plug-in connectors with 2.54 to 7.62 mm pitch, screw, spring-cage, and insulation displacement connection, wave soldering.
From page 71



COMBICON high density & data

Plug-in connectors in miniature format - fast insulation displacement, spring, and pierce connection technology, T-branches for easy bus connections.
From page 45

From page 45



COMBICON power

Connection technology for power electronics: PCB terminal blocks and plug-in connectors for currents up to 125 A, screw and spring-cage connection, panel feed-throughs.
From page 439

From page 439



COMBICON compact

Device connections for building technology and LED applications: PCB terminal blocks and plug-in connectors with 2.5 to 7.5 mm pitch, screw and spring-cage connection as well as pin strips.
From page 385

From page 385

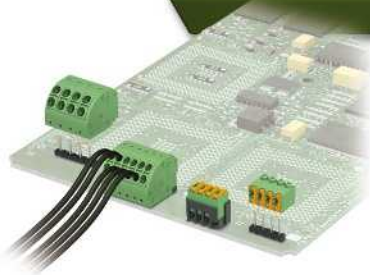

Housing

Plastic and aluminum electronics housing: component housing and panel mounting bases for industrial electronics, component housing for building installation, innovative bus connections between housing.
From page 647

From page 647

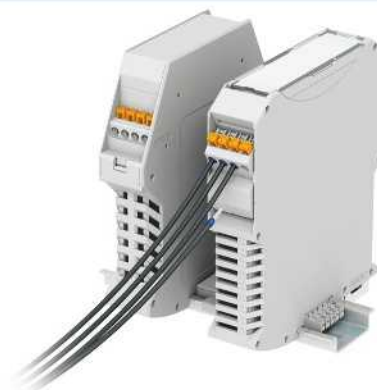

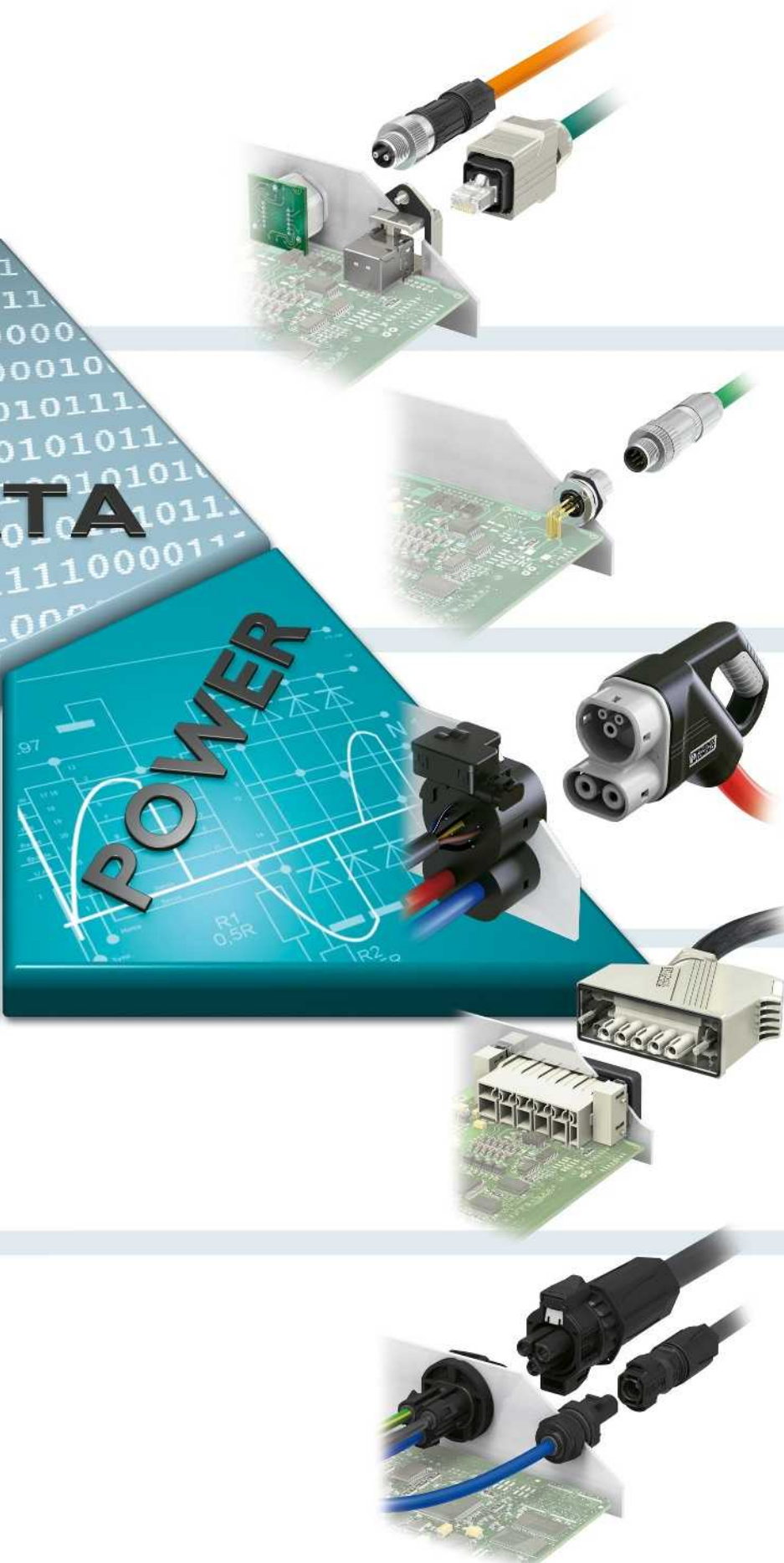

PLUSCON data

Plug-in connectors, panel feed-throughs, and cables for fieldbuses and networks.

See Catalog 2

PLUSCON circular

Flush-type plugs, plug-in connectors for assembly, and cables from M5 to M58 for signals, data, and power.

See Catalog 2

PLUSCON power

Plug-in charging systems for electromobility up to 400 A and plug-in connectors for power electronics up to 150 A.

See Catalog 2

PLUSCON device

Rectangular plug-in connectors with modular contact system for signals, power, and fiber optics with IP67 protection and available in various sizes.

See Catalog 2

PLUSCON solar

AC and DC connection systems for photovoltaic modules, inverters, and micro inverters.

See Catalog 2

Individual connection solutions for your application



Customer-specific adaptation of standard products

Found a product in our catalogs that meets your technical requirements, but you'd prefer a tailored solution? No problem – our Solution Center will be happy to provide you with support in implementing your requirements. Whether it's individual colors, special printing, a specific number of contacts or complete cable assembly – just let us know what you want.



New customer-specific product developments

Phoenix Contact has been producing high-quality products for worldwide use for over 85 years.

Benefit from our extensive development, manufacturing, and process expertise for your individual solution. Together with you, we can transform great ideas into innovative products.

Intelligent solutions in housing and connection technology increasingly require custom concepts.

As a manufacturer, you can develop products with us that meet the requirements of today's markets, such as high quality, individual design, and great customer benefits at a reasonable price.

You will have the entire expertise of the Phoenix Contact Group at your disposal. From our own tool shop and machine building through plastic injection molding and metal production to expertise in electronics production, we offer a depth of manufacturing that enables us to implement even demanding projects and complex products within a short development period.

Our own laboratory carries out testing throughout the process, handles the necessary qualifications and, of course, international approvals.

As a manufacturer, you can focus on your core competencies and benefit from our expertise as specialists in connection and housing technology.

Great products need great ideas and experience. Together with the expertise of Phoenix Contact, you can implement your individual solution - right from the initial idea to cost-effective series production.

Our products and services range from customer-specific PCB connection technology with screw, spring or IDC fast connection, in all conceivable designs and colors...

...through corresponding electronics housing in special designs in the color and size of your choice, together with the appropriate connection technology...

...individual field cabling, with plug-in connectors with shielding for high data transmission speeds, splash-proof housing for harsh industrial environments...

...to complete solutions consisting, for example, of splash-proof housing including the appropriate connection technology for signal, data, and power transmission, plus the ideal PCB connection.



Our service – added value for you

Phoenix Contact doesn't just offer the right products, it also provides a professional service for all aspects of device development. Wherever you are in the world, Phoenix Contact's global network means that you can rely on our service. Being at home all over the world and speaking the language of the user is what we understand by customer proximity. Proximity that ensures the best service for our partners. We live up to this with more than 40 customer-oriented subsidiaries and around 30 representatives in other countries.



Personal consultation and support

As our customer, you are always the focus of attention at Phoenix Contact, whether during consultation or as part of after sales support. Expert and personal consultation forms the basis of this approach. Even though we live in the age of the Internet, personal interaction with our customers is of great importance to us.

Our team of highly motivated staff are available to you at locations around the world.



Reliable delivery service

It goes without saying that our products are delivered reliably and on time. In addition to our optimized delivery service, we offer numerous options for making the purchasing process more efficient and transparent.

With warehouses in key industrial locations throughout the world, we ensure that you receive your products from Phoenix Contact cost-effectively and within the required delivery time.

Online catalog

The online catalog provides comprehensive, up-to-date information in 7 languages for more than 22,000 products from Phoenix Contact. Here you can find product-specific information such as technical data, notes on approvals, dimensional drawings, 3D data, etc.. At the click of the mouse, you can easily generate a product data sheet in PDF format.

In over 15 countries, e-shop functions complete the online catalog. Following successful registration, you can access your prices and delivery schedules at any time and you also have the option of placing orders directly online.

www.phoenixcontact.net/products

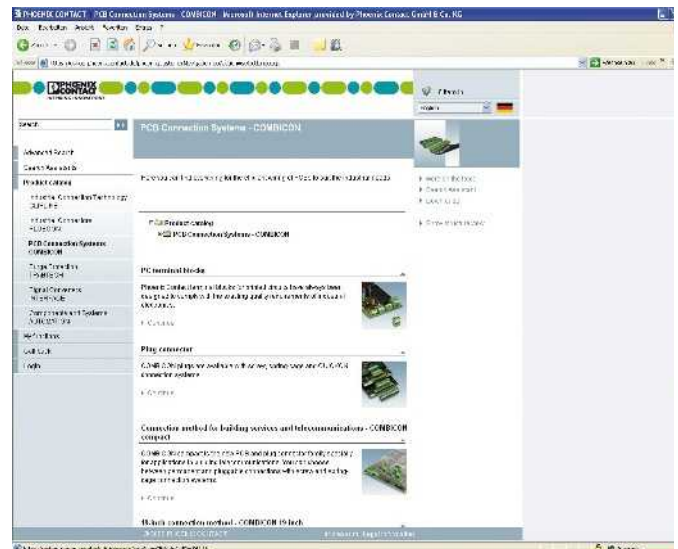

Find product-specific information quickly in the online catalog

Online search assistants

Online search assistants help you to search systematically and quickly for products from our extensive range of plug-in connectors. By selecting electrical values and other product properties, you are taken directly to the products that meet your requirements.

- COMBICON select
PCB connection and electronics housing
- PLUSCON field select
Flush-type plugs for sensor/actuator applications
- PLUSCON data select
Device plug-in connectors for fieldbuses and networks
- PLUSCON circular select
M17 to M58 device plug-in connectors

www.phoenixcontact.net/products

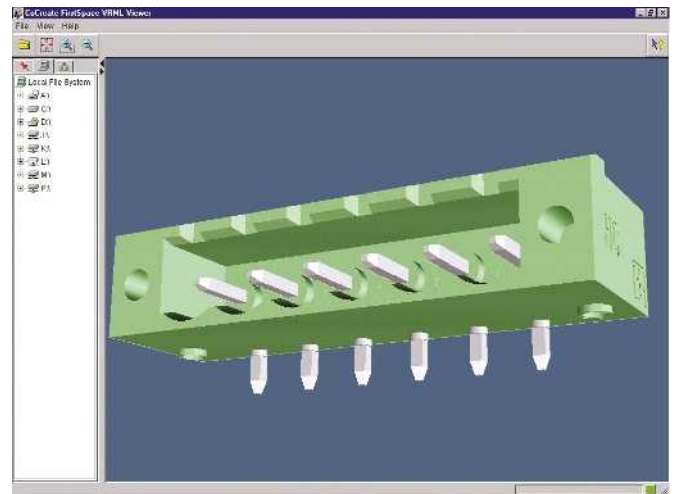

Easy download of 3D data

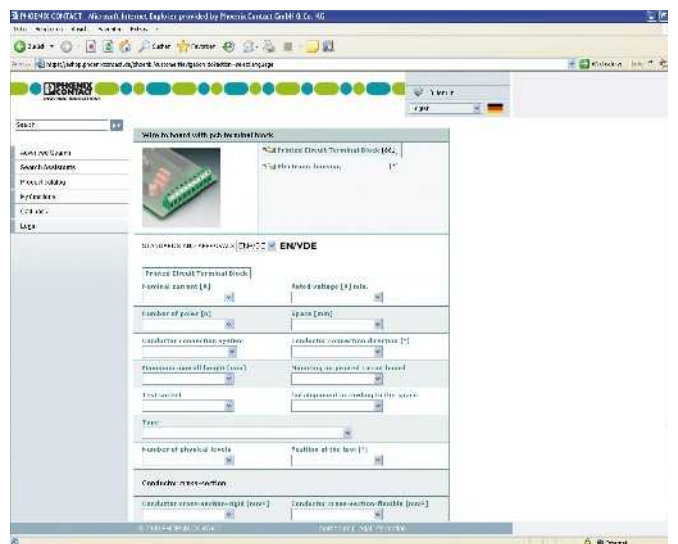

User-friendly product search with COMBICON select

Product range overview

COMBICON HD - miniature PCB terminal blocks and plug-in connectors with high contact density

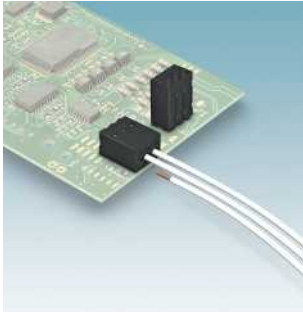

Miniature THR/SMD PCB terminal blocks and plug-in connectors with 2.5 mm pitch
PTSM 0,5...THR Page 51
PTSM 0,5...SMD Page 53

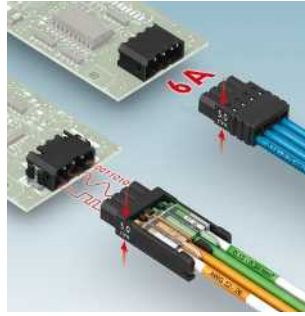

Miniature plugs and headers with 2.5 mm pitch
PTSM 0,5... Page 55
PTPM Page 55



Miniature PCB terminal block with displacement connection with 2.5 mm pitch
PTQ 0,3...THR Page 63



Plug-in connectors with displacement connection and headers with 2.0 mm pitch
CIOC...(M)(F) Page 65
CIOC...F(V)(H) Page 67

COMBICON control – multi-position and multi-level PCB terminal blocks

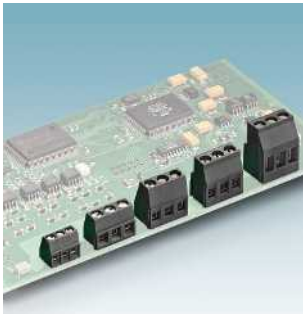

Through hole reflow applications with screw connection
 3.5/3.81/5.0/5.08 mm pitch
MKDS Page 75

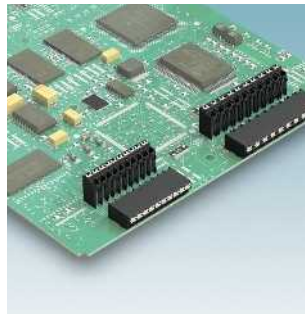

Through hole reflow applications with push-in spring connection
 3.5/3.81/5.0/5.08 mm pitch
SPT-THR 1,5 Page 78

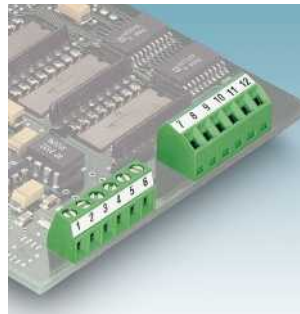

Multi-position PCB terminal blocks
 2.54/3.5/3.81 mm pitch
MPT 0,5; 0,5 mm² Page 83
SMKDS 1; 1,5 mm² Page 85

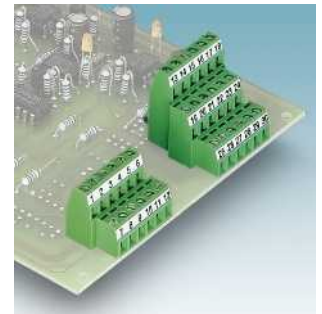

Double and three-level PCB terminal blocks with 3.5/3.81 mm pitch
MKDS 1/... Page 85
MK3DS 1/... Page 87

Multi-position and multi-level PCB terminal blocks with screw connection

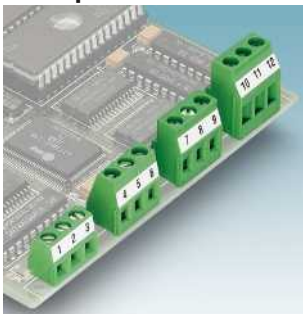

MKDSN 1,5; 1,5 mm² Page 91
MKDS 1,5; 1,5 mm² Page 95
MKDSN 2,5; 2,5 mm² Page 103

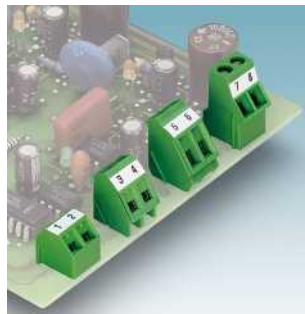

SMKDSN 1,5; 1,5 mm² Page 91
SMKDS 1,5; 1,5 mm² Page 87
SMKDS 2,5; 2,5 mm² Page 103

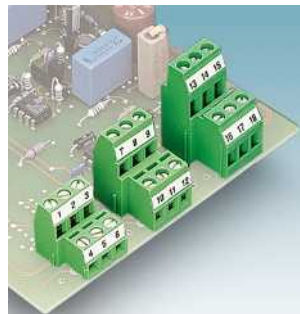

Double-level PCB terminal blocks
MKKDSN 1,5; 1,5 mm² Page 93
MKKDS 1,5; 1,5 mm² Page 97
MKKDS 3; 2,5 mm² Page 109

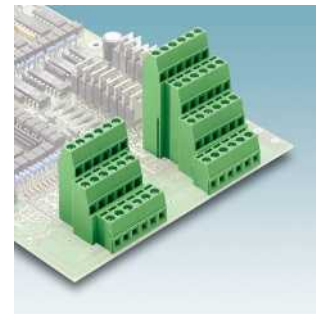

Multi-level PCB terminal blocks
MK3DS 1,5/...-5,08 Page 99
MK4DS 1,5/...-5,08 Page 101
MK3DS 3/...-5,08 Page 111

High, flat, and multi-position PCB terminal blocks with screw connection

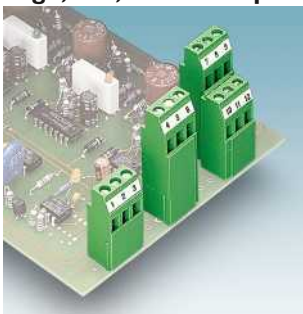

High PCB terminal blocks with 5.0/5.08 mm pitch
MKKDSNH 1,5/...-5,08 Page 93
MK3DS 1,5/...-5,08-BC Page 99

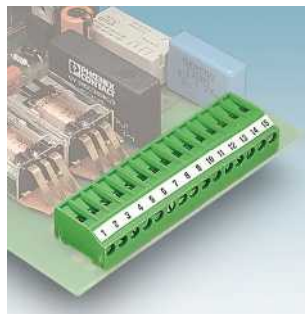

Horizontal design with 3.5/5.0 mm pitch
MKDSFW 1,5/...-3,5 Page 87
MKDSFW 3/... Page 107

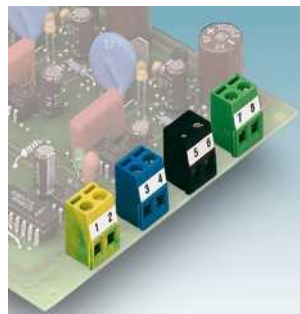

With internal bridging
MKDS 1,5-B; 1,5 mm² Page 97
MKDS 3-B; 2,5 mm² Page 105



Orthogonal PCB terminal blocks
MKDSO 1,5/...-3,5 Page 89
MKDSO 2,5/...-5,0 Page 113
MKDSO 2,5 HV/...-7,5 Page 125

COMBICON control – multi-position PCB terminal blocks with screw connection

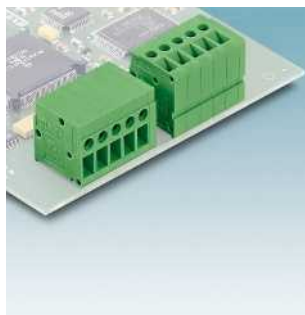

Horizontal and vertical PCB terminal blocks with front connection with 5.0 mm pitch, 2.5 mm² connection cross section
FRONT 2,5/... Page 114

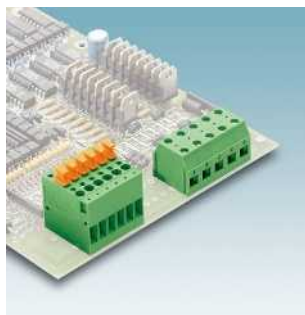

KDS (2,5) Page 117
KDS 3-PMT Page 168
KDS 3-MT Page 117
KDS(P) 4 Page 127

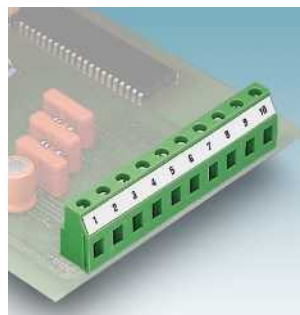

7.5/7.62 mm pitch
GMKDSN 1,5; 1.5 mm² Page 119
GMKDS 1,5; 1.5 mm² Page 121

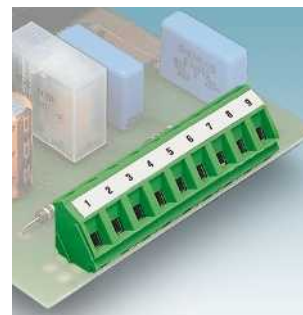

7.5/7.62 mm pitch
GSMKDSN 1,5; 1.5 mm² Page 119
GSMKDSP 1,5; 1.5 mm² Page 121
GSMKDS 3; 2.5 mm² Page 123

PCB terminal blocks with spring-cage connection or push-in spring connection

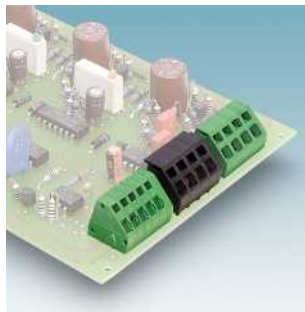

Angled PCB terminal blocks with spring-cage connection
ZFKDS 1-3,81 Page 129
ZFKDS 2,5-5,08 Page 135

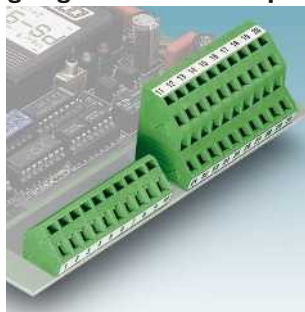

Compact design, 5.0 mm pitch, 1.5 mm² connection cross section
ZFKDS 1,5C-5,0 Page 131

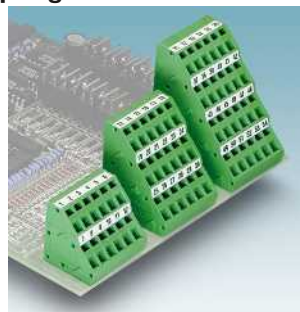

Two, three, and four-level PCB terminal blocks with 5.08 mm pitch, 2.5 mm² connection cross section Page 133

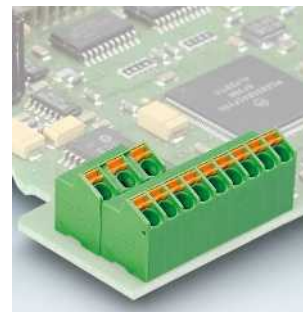

Angled PCB terminal blocks with push-in spring connection
SPTA 1/... Page 137
SPTA 1,5/... Page 139

PCB terminal blocks with push-in spring connection or displacement connection

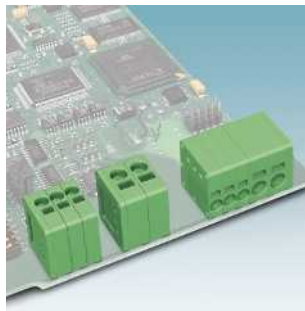

Horizontal and vertical push-in spring connection, 3.5/5.0 mm pitch
SPT 1,5/...-3,5 Page 141
SPT 2,5/...-5,0 Page 143

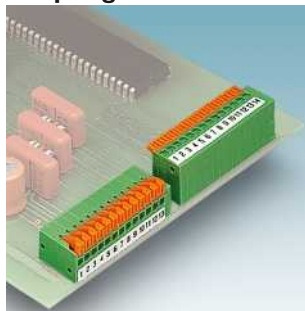

Horizontal and vertical push-in spring connection, 2.54/3.81/5.08/7.62 mm pitch
FFKDS(A)... Page 145



Orthogonal push-in spring connection
FKDSO... Page 153

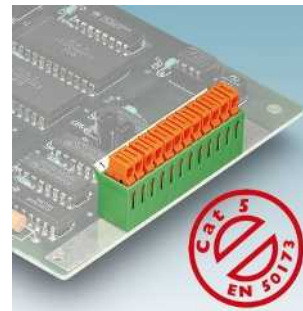

Displacement connection with 3.81 mm pitch, 0.5 mm² connection cross section
IDC 0,3/...-3,81 Page 154

PCB terminal blocks with screw connection or spring connection for the Ex area

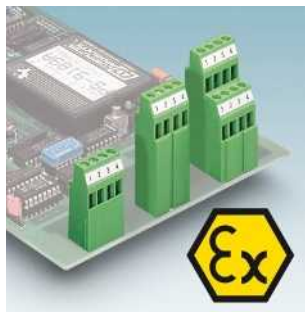

High PCB terminal blocks with 5.0/5.08 mm pitch
MKKDSH 3/...-EX Page 157
MK3DSH 3/...-5,08-EX Page 157
MK3DSMH 3/...-5,08-EX Page 157

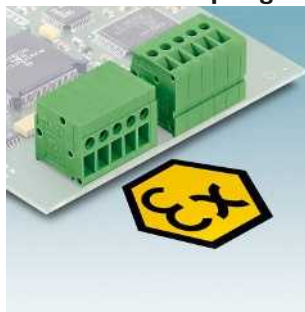

Horizontal and vertical PCB terminal blocks with front connection with 5.0 mm pitch, 2.5 mm² connection cross section
FRONT 2,5/...-EX Page 158

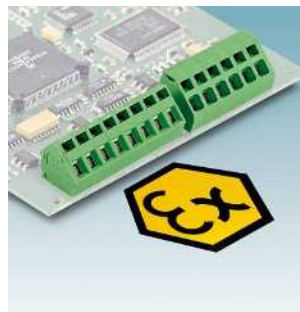

Spring-cage connection with 5.0/5.08 mm pitch
ZFKDS 1,5C-5,0-EX Page 161
ZFKDS 2,5-5,08-EX Page 161

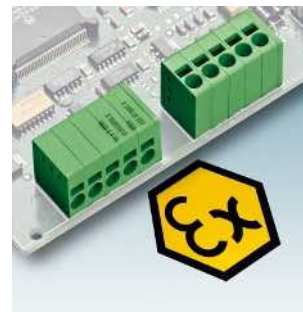

Horizontal and vertical push-in spring connection with 3.5/5.0 mm pitch
SPT 2,5/...-5,0-EX Page 163

Product range overview

COMBICON control - plug-in connector systems with 2.5/2.54/3.5/3.81 mm pitch



Plugs and headers, 2.5 mm pitch
FK-MC 0,5/...-ST-2,5 Page 168
MC(V) 0,5/...-G-2,5(THT) Page 172



Push-in plugs and headers for THR and SMD processes with 2.54 mm pitch
FMC 0,5; 0,5 mm² Page 174



Double-row plug-in connector with push-in spring connection, 3.5 mm pitch
DFMC 1,5/...-ST(F)-3,5(-LR) Page 184

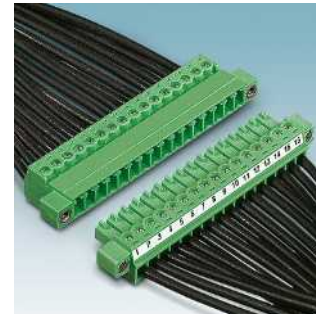

Inverted plugs with screw connection, 3.81 mm pitch
MC 1,5/...-ST(F)-... Page 190
IMC 1,5/...-ST(F)-3,81 Page 196

Plug-in connectors with 3.5/3.81 mm pitch with screw or push-in spring connection

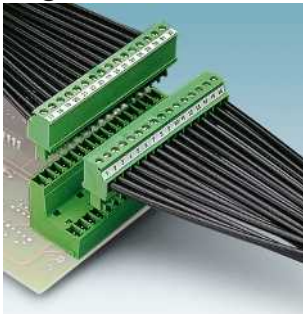

Plugs with 3.5/3.81 mm pitch, plug-in direction vertical to the conductor axis
MCVR(W) 1,5/...-ST(F)-... Page 192



Plugs with front connection, 3.81 mm pitch
FRONT-MC 1,5/...-ST(F)-... Page 194

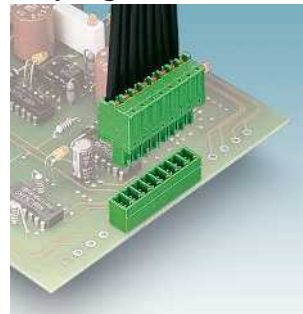

Plugs with push-in spring connection, 3.5/3.81 mm pitch
FK-MCP 1,5/...-ST(F)-... Page 198



Plugs with push-in spring connection, 3.5/3.81 mm pitch, flat, compact design
FMC 1,5/...-ST(F)-... Page 200

Plug-in connectors with 3.5/3.81 mm pitch and headers for reflow and wave soldering processes

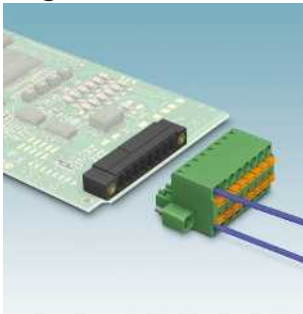

TWIN plugs with push-in spring-cage connection, 3.5/3.81 mm pitch, for potential distribution
TFMC 1,5/...-ST(F)-... Page 202

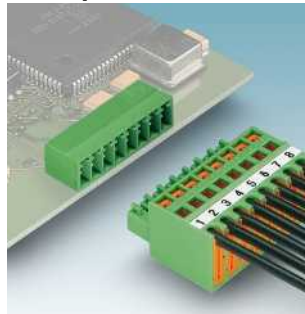

Plugs with IDC displacement connection, 3.81 mm pitch, connection cross section 0.5 mm²
QC 0,5/...-ST(F)-3,81 Page 204



Plugs with crimp connection, 3.81 mm pitch, 1.0 mm² connection cross section
MCC 1/...-STZ(F)-3,81 Page 206

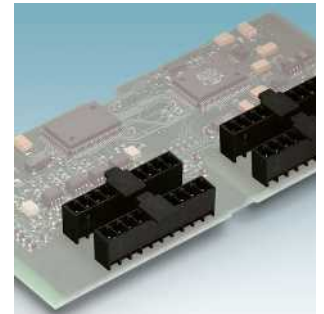

Reflow solderable headers, 3.5/3.81 mm pitch, horizontal and vertical plug-in direction
 Page 208

Headers with 3.5/3.81 mm pitch for press-in technology and wave soldering processes

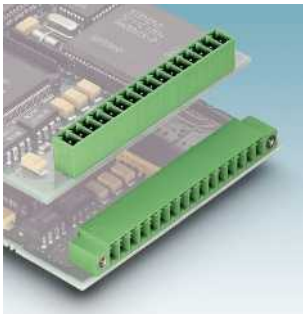

Headers for press-in technology, 3.5/3.81 mm pitch, horizontal and vertical plug-in direction
EMC(V) 1,5/...-G(F)-... Page 222

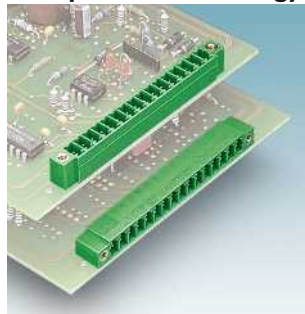

Headers for wave soldering process, 3.5/3.81 mm pitch, horizontal and vertical plug-in direction
MC(V) 1,5/...-G(F)-... Page 224

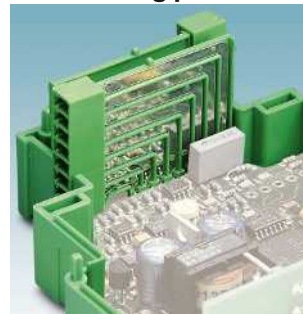

Headers with 3.81 mm pitch with orthogonal plug-in direction
MCO 1,5/...-G-3,81 Page 231



Headers with 3.5 mm pitch with orthogonal plug-in direction
MCO 1,5/...-G1...-3,5 Page 232

COMBICON control - headers with 3.81 mm pitch

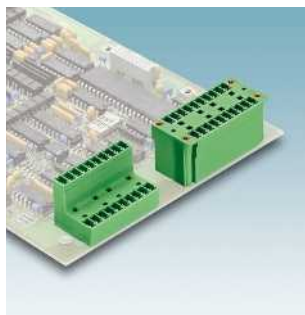

Double-level headers, 3.81 mm pitch, horizontal and vertical plug-in direction
MCD(V) 1,5/...-G(F)-3,81 Page 234

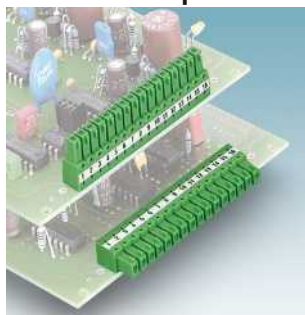

Inverted headers, 3.81 mm pitch, horizontal and vertical plug-in direction
IMC(V) 1,5/...-G(F)-3,81 Page 238



Feed-through headers, 3.81 mm pitch, with spade connection
DFK-MC 1,5/...-G(F)-3,81 Page 240



Cable housing for screw plugs, 2- to 16-pos., 3.81 mm pitch
KGK-MC 1,5/...-G(F)-3,81 Page 242
MCVR 1,5/...-ST(F)... Page 192

Plug-in connectors with 5.0/5.08 mm pitch with screw connection

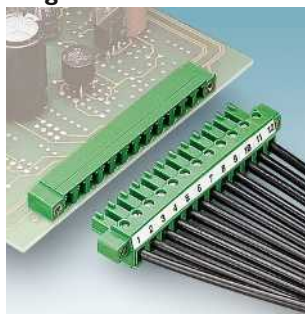

Plugs with screw connection and headers, 5.08 mm pitch
MC 1,5/...-ST(F)-5,08 Page 246

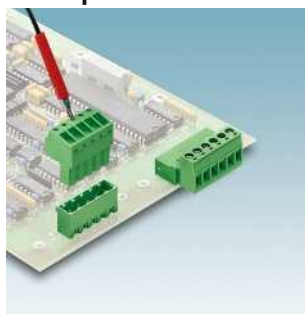

Plugs with screw connection, 5.0/5.08 mm pitch, with/without test connection
MSTB 2,5/...-ST(F)... Page 262

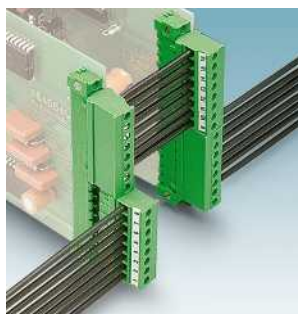

Plugs with screw connection, 5.0/5.08 mm pitch, plug-in direction 90° to the conductor axis
MVSTBR(W) 2,5/...-ST(F)... Page 266

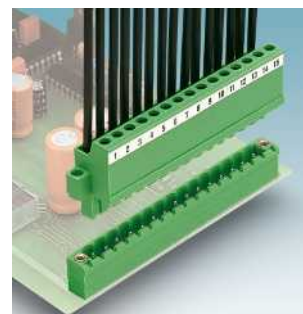

Plugs with front screw connection, 5.0/5.08 mm pitch
FRONT-MSTB 2,5/...-ST(F)... Page 269

Plug-in connectors with 5.0/5.08 mm pitch with screw and push-in spring connection

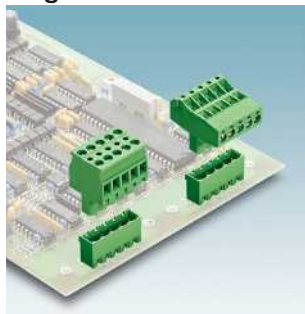

TWIN plugs, 5.08 mm pitch, for potential distribution
TMSTBP 2,5/...-ST(F)-5,08 Page 270

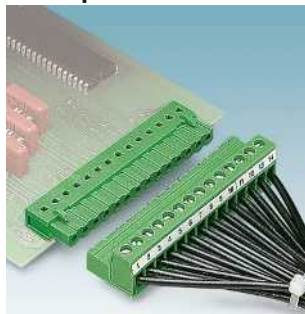

Inverted plug with screw connection, 5.08 mm pitch
IC 2,5/...-ST(F)-5,08 Page 272

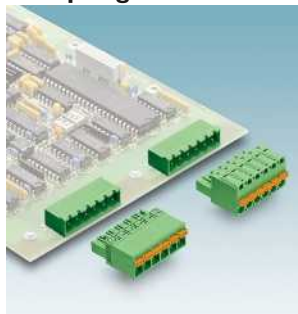

Plugs with push-in spring connection, 5.0/5.08 mm pitch
FKC(T) 2,5/...-ST(F)... Page 274

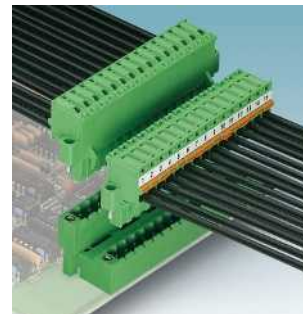

Plugs with push-in spring connection, 5.0/5.08 mm pitch, plug-in direction 90° to the conductor axis
FKCVR(W) 2,5/...-ST(F)... Page 280

Plug-in connectors with 5.0/5.08 mm pitch with push-in spring or insulation displacement connection



TWIN plugs with push-in spring connection, 5.0 mm pitch, for potential distribution
TVFKC 1,5/...-ST-5,0 Page 282



TWIN plugs with push-in spring connection, 5.08 mm pitch, for potential distribution
TFKC 2,5/...-ST-5,08 Page 284

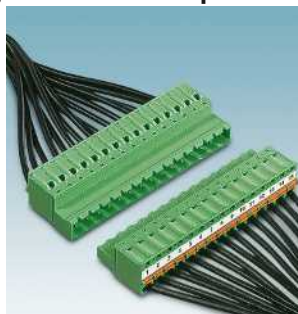

Inverted plug with push-in spring connection, 5.0/5.08 mm pitch
FKIC 2,5/...-ST(F)... Page 286

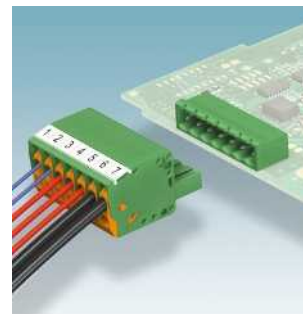

Plugs with IDC displacement connection, 5.0/5.08 mm pitch
QC 1,0/...-ST(F)-5,08 Page 290
QC 1,5/...-ST(F) Page 292

Device connection technology for signals, data, and power from Phoenix Contact

Product range overview

COMBICON control – plug-in connectors with 5.0/5.08 mm pitch with crimp connection and header

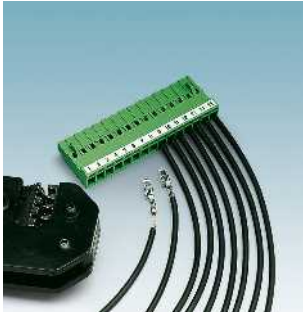

Plugs with crimp connection, 5.08 mm pitch
MSTBC 2,5/...-ST(Z)(F)-5,08 Page 294

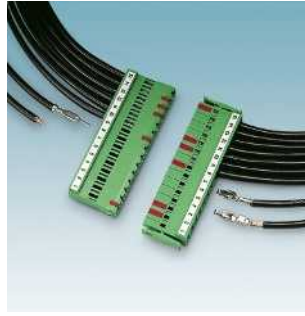

Inverted plugs with crimp connection, 5.08 mm pitch
ICC 2,5/...-STZ(F)-5,08 Page 296

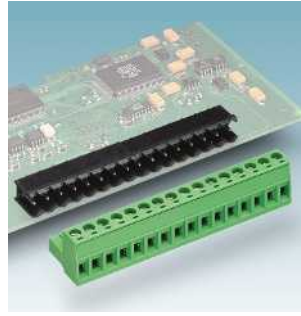

Reflow solderable headers, 5.0/5.08 mm pitch, horizontal and vertical plug-in direction
CCA(V) 2,5/...-G(F)-... THR Page 298

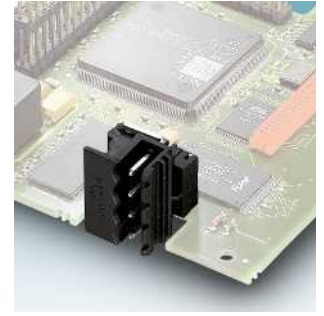

Reflow solderable headers, 5.0 mm pitch, with orthogonal plug-in direction
MSTBO 2,5/...-G1-5,0 THR Page 308

Headers with 5.0/5.08 mm pitch for press-in technology and wave soldering processes

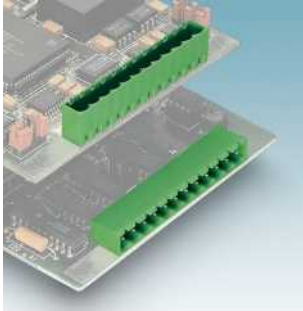

Headers for press-in technology, 5.0/5.08 mm pitch, horizontal and vertical plug-in direction
EMSTB(V) 2,5/...-G(F)-... Page 310

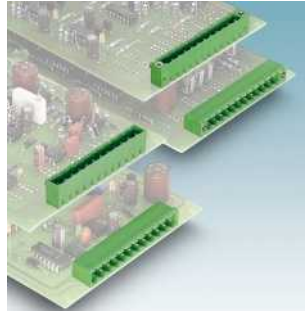

Headers for wave soldering processes, 5.0/5.08 mm pitch, horizontal and vertical plug-in direction
MSTB(V) 2,5/...-G(F)-... Page 312

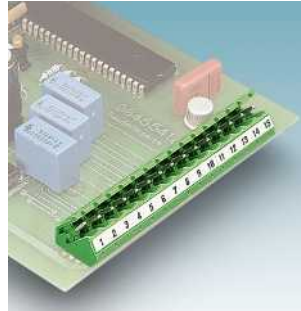

Headers with 5.0/5.08 mm pitch, angled plug-in direction, with/without side panel
SMSTB(A) 2,5/...-G(F)-... Page 318

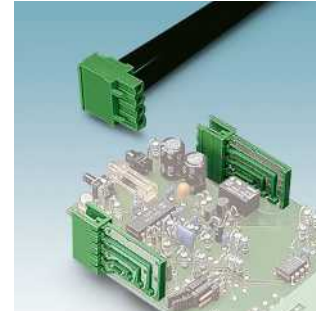

Headers with 5.08 mm pitch orthogonal plug-in direction
MSTBO 2,5/...-G1-5,08 Page 320

Headers with 5.0/5.08 mm pitch



Headers with 5.0 mm pitch orthogonal plug-in direction, wave/reflow soldering processes
MSTBO 2,5/...-G1...-5,0 Page 322

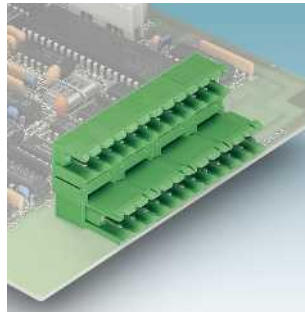

Double-level headers, 5.0/5.08 mm pitch, horizontal and vertical plug-in direction, with level offset
MDSTB(V) 2,5/...-G(F)-... Page 326

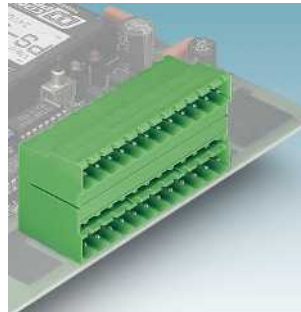

Double-level headers, 5.0/5.08 mm pitch, horizontal and vertical plug-in direction, without level offset
MDSTB(V) 2,5/...-G1(F)-... Page 329

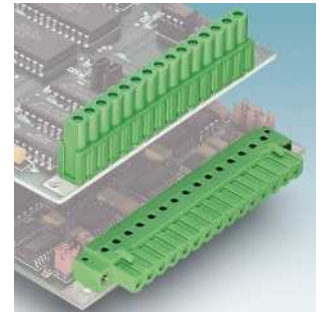

Inverted headers, 5.08 mm pitch, horizontal and vertical plug-in direction
IC(V) 2,5/...-G(F)-5,08 Page 332

Plug-in connectors with 7.5/7.62 mm pitch with screw and push-in spring connection

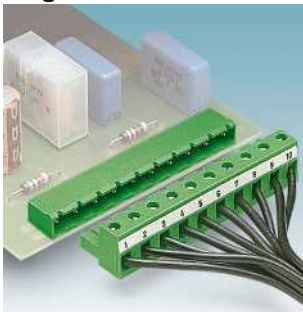

Plugs with screw connection, 7.5/7.62 mm pitch, plug-in direction parallel to the conductor axis
GMSTB 2,5/...-ST(F)-... Page 334

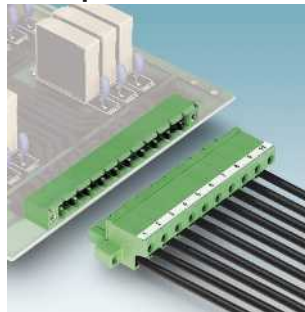

Plugs with front screw connection, 7.5/7.62 mm pitch
FRONT-GMSTB 2,5/...-ST(F)-... Page 335

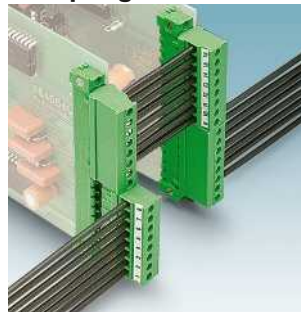

Plugs with screw connection, 7.5/7.62 mm pitch, plug-in direction 90° to the conductor axis
GMVSTBR(W) 2,5/...-ST(F)-... Page 336

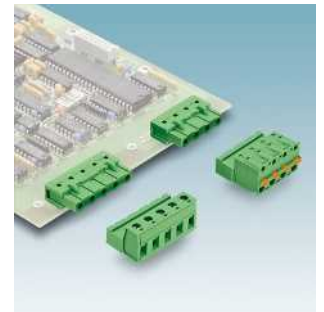

Inverted plug with screw and spring connection, 7.62 mm pitch
GIC 2,5/...-ST(GF)-7,62 Page 338
GFKIC 2,5/...-ST-7,62 Page 341

Plug-in connectors with 7.5/7.62 mm pitch with push-in spring-cage connection and headers with 7.5/7.62 mm pitch

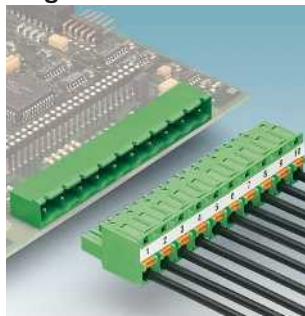

Plugs with push-in spring connection, 7.5/7.62 mm pitch, plug-in direction parallel to the conductor axis
GFKC 2,5/...-ST(F)-... Page 340

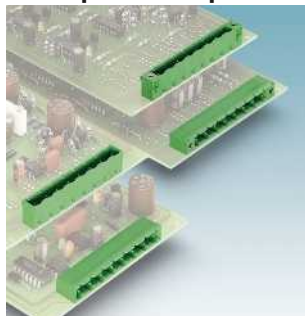

Headers with 7.5/7.62 mm pitch, horizontal and vertical plug-in direction
GMSTB(V) 2,5/...-G(F)-... Page 342

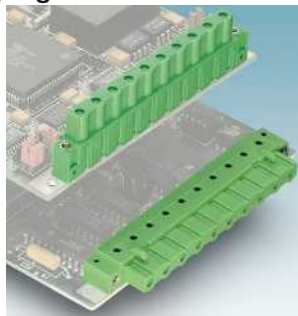

Inverted headers with 7.5/7.62 mm pitch, horizontal and vertical plug-in direction
GIC(V) 2,5/...-G(F)-... Page 346



Cable housing for plugs with screw connection, 2- to 24-pos., 5.0/5.08/7.5/7.62 mm pitch
Page 348

Plug-in connectors for panel feed-throughs and for direct mounting



Feed-through assembly frames for inverted plug-in connectors, 5.08 mm pitch, with/without threaded flange
IC-DFR-... Page 350



Headers for panel feed-through, 5.0/5.08 mm pitch, with spade connection
DFK-MSTB 2,5/...-G(F)-... Page 352



Headers for panel feed-through, 5.08 mm pitch, with spade connection
DFK-MSTB(A) 2,5/...-G(F)-... Page 354

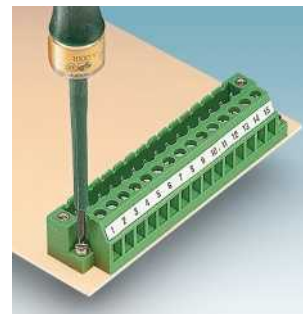

Plugs/headers with screw connection and screw flange for direct mounting
MSTBU 2,5/... Page 356

Plug-in connectors for DIN rail mounting, for direct contacting with PCBs and special designs

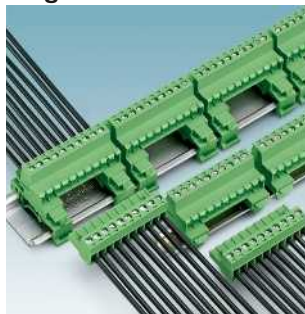

Inverted plugs for mounting on DIN rails, 5.0/5.08 mm pitch
Page 358



Plugs and headers for mounting on DIN rails, 5.08 mm pitch
Page 360

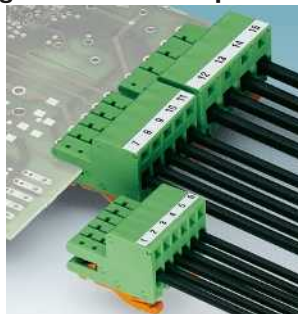

Direct plug-in connectors with spring-cage connection
ZEC 1,0/...-ST-3,5 Page 365
ZEC 1,5/...-ST-5,0 Page 365



Plugs with screw connection, for D-SUB panel feed-throughs and headers
PSC 1,5/... Page 251

Plug-in connectors for the Ex area and plug-in card blocks

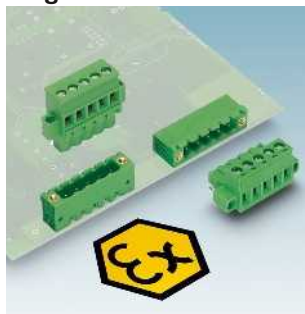

Plugs with screw connection and headers for the Ex area
Page 368

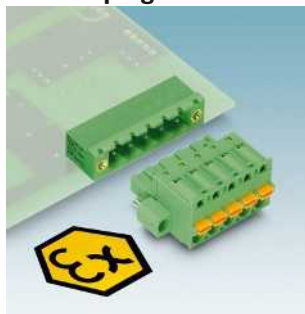

Plugs with push-in spring connection for the Ex area, 5.08/7.62 mm pitch
FKC 2,5/...STF5,08 EX Page 371
GFKC 2,5/ 2-STF-7,62 EX Page 381



Plug-in card blocks for European-format cards with indirect connection
Page 776

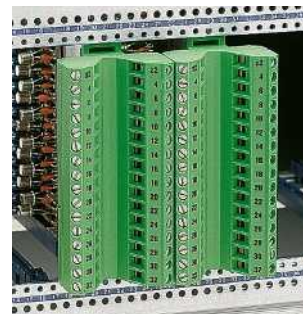

Socket strips with screw and spring-cage connection
Page 788

Product range overview

COMBICON compact - connection technology for buildings and LED applications



Miniature PCB terminal blocks and plugs
PTSM 0,5...THR Page 391
PTSM 0,5...SMD Page 53

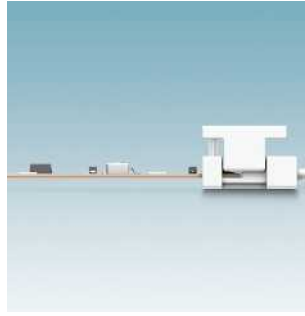

Plug-in connectors for flexible PCBs
PTF 0,3... Page 401
PTPM Page 55

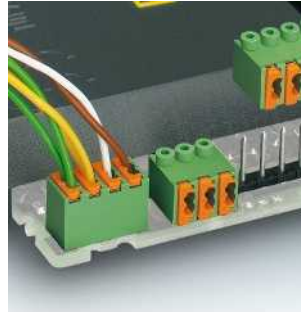

PCB terminal blocks and plugs with spring-cage double connection up to $2 \times 0,5 \text{ mm}^2$
FK-MPT 0,5-3,5 series Page 403

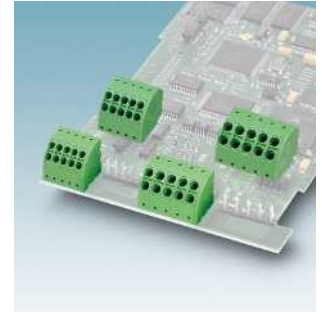

Angled pin strip plugs with spring-cage connection of $2 \times 1,5 \text{ mm}^2$ and $2 \times 2,5 \text{ mm}^2$
PTDA series Page 407

PCB terminal blocks and plug-in connectors with spring/screw connection

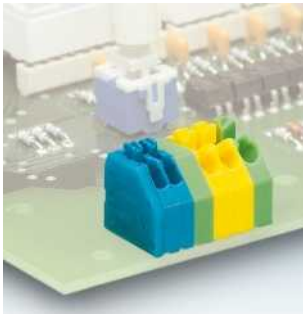

Angled PCB terminal block with spring-cage connection, $1,5 \text{ mm}^2$
PTSA series Page 413

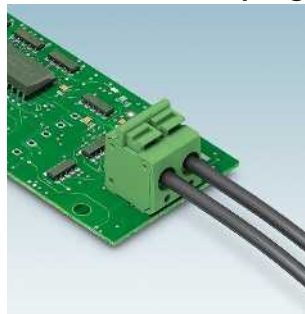

PCB terminal block with horizontal spring-cage connection
PTS series Page 415

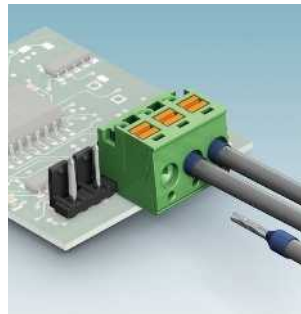

Pin-strip plugs with spring connection
PTS 1,5/...-PH-5,0 Page 417

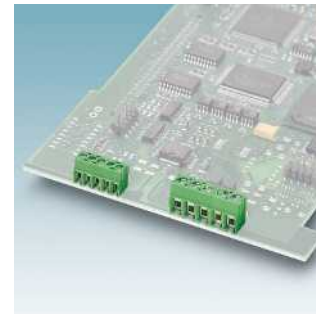

PCB terminal blocks with horizontal screw connection and conductor protection, $1,5$ or $2,5 \text{ mm}^2$
PT 1,5 series Page 419

PCB terminal blocks and plug-in connectors with screw connection

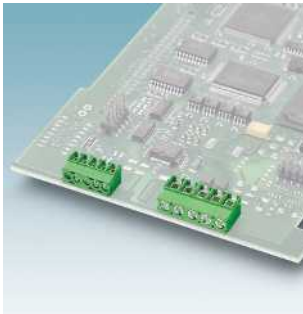

PCB terminal blocks with vertical screw connection and conductor protection, $3,5 \text{ mm}$ pitch
PT 1,5 series Page 419

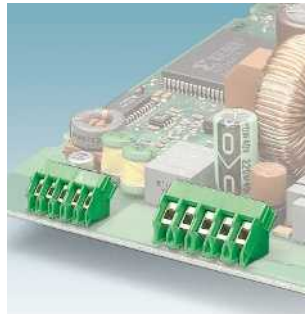

PCB terminal blocks with angled screw connection and conductor protection, $5,0 \text{ mm}$ pitch
PTA 1,5 series Page 419

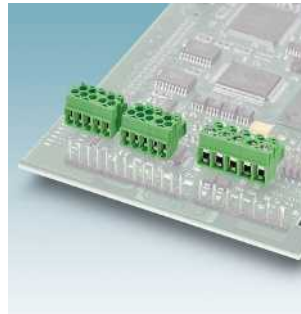

Pin strip plugs with screw connection and conductor protection clips, $1,5$ or $2,5 \text{ mm}^2$
PT 1,5/-PVH/PH series Page 423

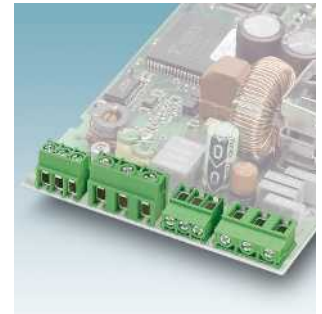

PCB terminal blocks with screw connection and conductor protection clips, 4 mm^2
PT 2,5 series Page 427

Plug-in connectors and pin strips

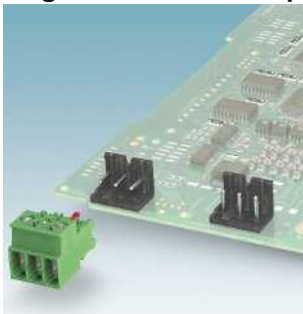

Multi-plug-in system with screw connection and base strips, up to 4 mm^2
PT 2,5/...-PVH series Page 431

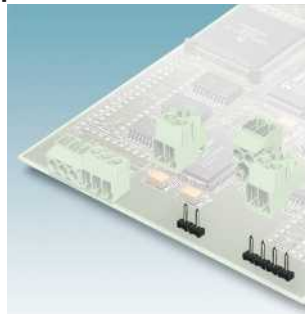

Vertical and horizontal pin strips for COMBICON compact plugs, reflow solderable
PST family Page 432



Reflow solderable pin strips in machine-capable tape-on-reel packing
PST tape-on-reel packing Page 433

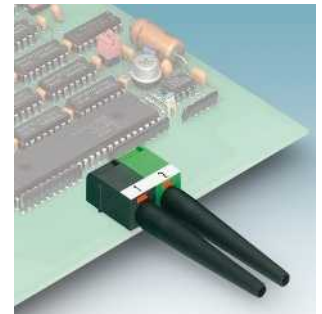

FO fast connection PCB terminal blocks for polymer fibers
FOPT 2,2-T/R Page 436

COMBICON power - PCB terminal blocks up to 16 mm² with screw connection



MKDS 5 series: screw connection, up to 32 A, 6.35/7.62/9.52 mm pitch
MKDS 5... Page 443

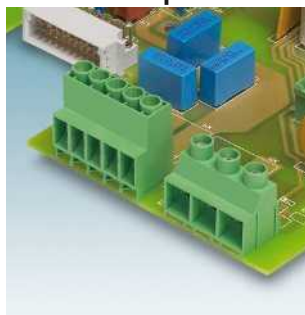

MKDS 5 HV series: screw connection, up to 41 A, 6.35 mm/9.52 mm pitch for 600 V UL
MKDS 5 HV... Page 445

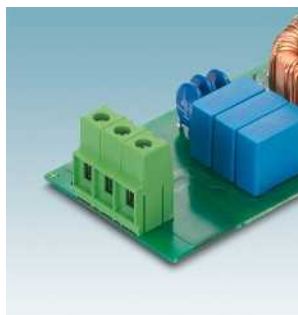

MKDSP 10 series: screw connection, up to 76 A, 10.16/12.7 mm pitch with test connection
MKDSP 10... Page 451



MKDS 10 HV series: screw connection, up to 76 A, 10.16 mm pitch for 600 V UL
MKDS 10... Page 451

PCB terminal blocks up to 35 mm² with screw connection

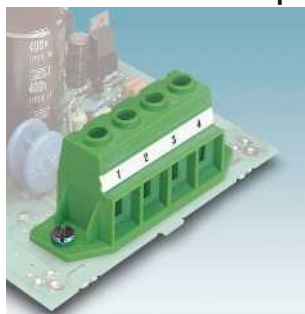

MKDSP 25 series: screw connection, up to 125 A, 15 mm pitch
MKDSP 25... Page 455

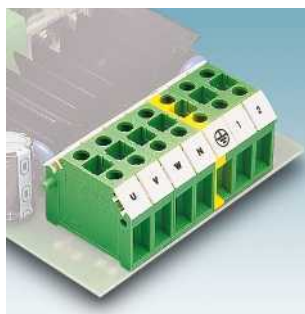

KDS 10 series: feed-through terminal block with screw connection, up to 76 A, 10 mm pitch
KDS 10/... Page 457

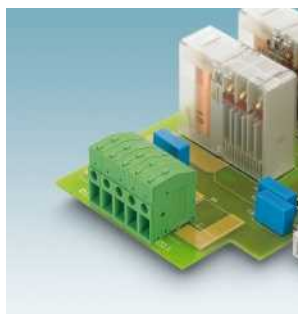

FRONT 4 series: front screw connection, up to 32 A, connection: horizontal, 6.35/7.62 mm pitch
FRONT 4 H... Page 459

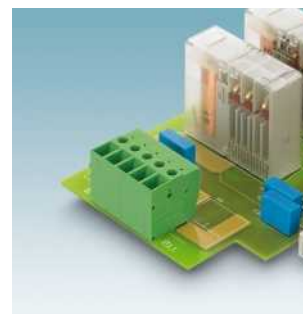

FRONT 4 series: front screw connection, up to 32 A, connection: vertical, 6.35/7.62 mm pitch
FRONT 4 V... Page 459

PCB terminal blocks up to 16 mm² with push-in spring connection

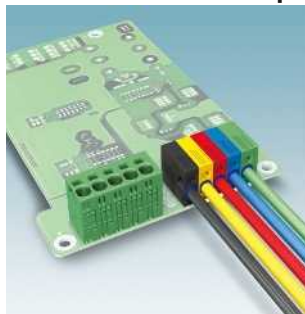

SPT 5 series: push-in spring connection, up to 41 A, connection: vertical and horizontal, 7.5 mm pitch
SPT 5... Page 463



PTSPL 6 series: push-lock spring connection, up to 41 A, without insulating body
PTSPL 6... Page 475

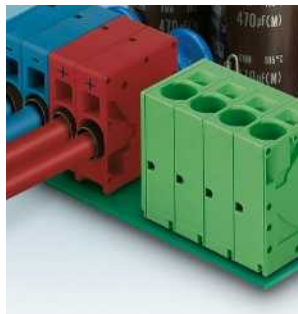

SPT 16 series: push-in spring connection, 10 mm pitch, up to 76 A, connection: vertical and horizontal
SPT 16... Page 467

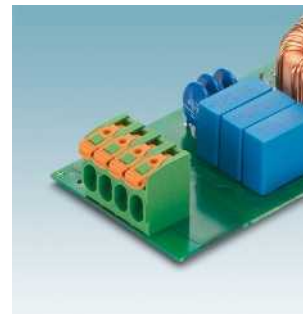

PLH-5 series: push-lock spring connection, pitch 7.5 mm, up to 41 A connection: horizontal
PLH 5... Page 470

PCB terminal blocks up to 16 mm² with push-lock spring connection and spring-cage connection



PLH 5 series: push-lock spring connection, 7.5 mm pitch, up to 41 A, connection: 30° to PCB
PLH/A 5... Page 470

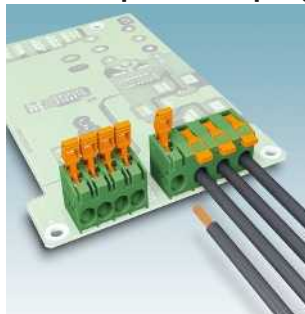

PLH 16 series: push-lock spring connection, 10/15 mm pitch, up to 76 A, connection: horizontal
PLH 16... Page 473



ZFKDS 4 series: spring-cage connection, up to 32 A, 7.5/10 mm pitch
ZFKDS 4... Page 477

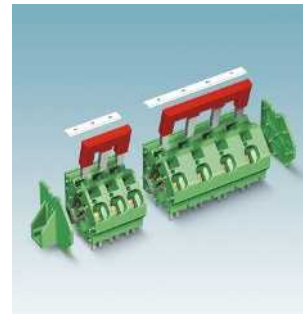

ZFKDS 10 series: spring-cage connection, up to 76 A, 10/15 mm pitch
ZFKDS 10... Page 479

Product range overview

COMBICON power - plug-in connectors up to 2.5 mm² with screw and spring connection

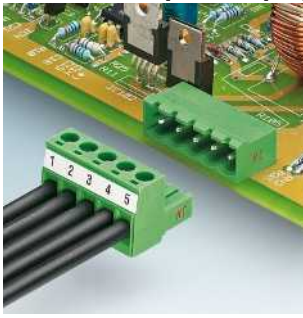

HC series: screw connection, up to 16 A, 5/5.08 mm pitch
MSTB 2,5 HC... Page 490

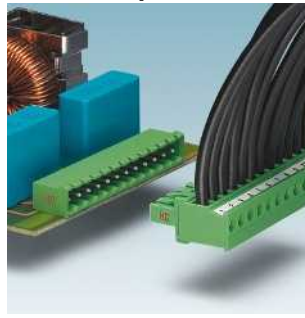

HC series: screw connection, vertical connection direction, up to 16 A, 5/5.08 mm pitch
MVSTBR(W) 2,5 HC... Page 492

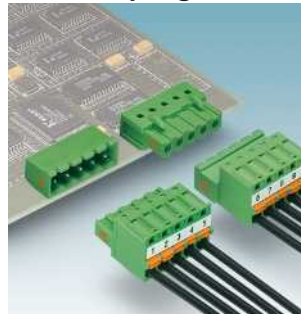

HC series: spring connection, up to 16 A, 5/5.08 mm pitch
FKC 2,5 HC... Page 494

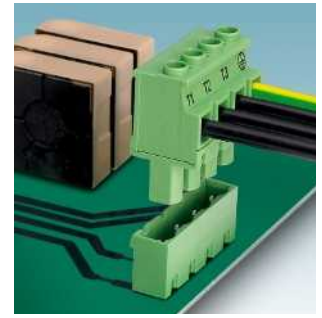

HV series: vertical connection direction, screw connection, up to 16 A, 7.62 mm pitch, 600 V UL
GMVSTBR/W 2,5 HV... Page 500

Plug-in connectors up to 2.5 mm² with screw and spring connection

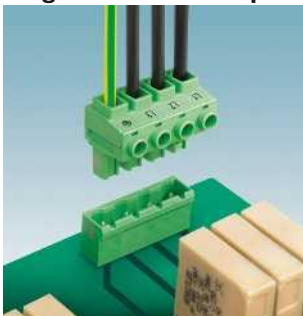

HC series: screw connection, up to 16 A, 7.62 mm pitch, 600 V UL
GMSTB 2,5 HCV... Page 502



HC series: screw connection, up to 16 A, 7.62 mm pitch, 600 V UL
GIC 2,5 HCV... Page 503

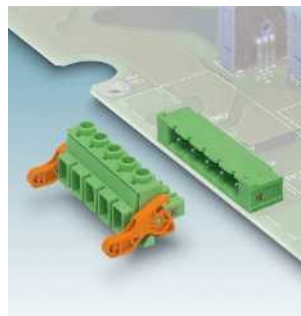

HC series: screw connection, up to 16 A, 7.62 mm pitch, 600 V UL
GMSTB 2,5 HCV L&R... Page 503



HC series: screw connection, up to 16 A, housing terminal, 600 V UL
GMSTBT 2,5 HV... Page 508

Plug-in connectors up to 4 mm² with screw and crimp connection

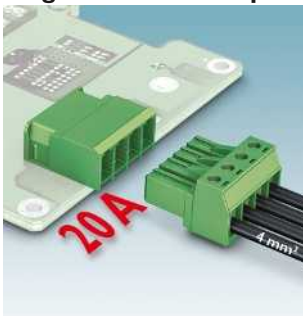

PC 4 series: plugs/headers, screw connection, up to 20 A, 7.62 mm pitch
PC 4 ... Page 512

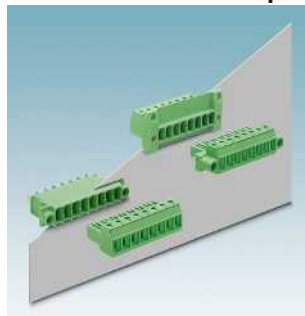

PC 4 series: feed-through plug screw or solder connection, up to 20 A, 7.62 mm pitch
DFK-PC 4... Page 518



PC 4 series: plugs, crimp connection, up to 20 A
PCC 4... Page 514



PC 4 series: cable housing for PC 4 plugs
KGG-PC 4/KGS-PC 4... Page 522

Plug-in connectors up to 6 mm² with screw and spring connection

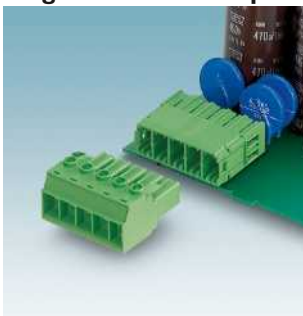

PC 5 series: plugs/headers, screw connection, up to 41 A, 7.62 mm pitch, also Click & Lock
PC 5 Page 524

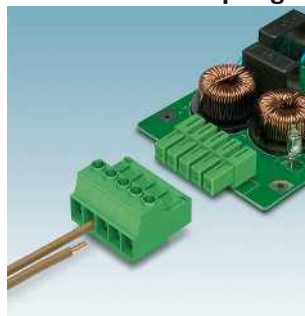

PC 5 series: inverted plugs/headers screw connection, up to 41 A, 7.62 mm pitch
IPC 5/... Page 526

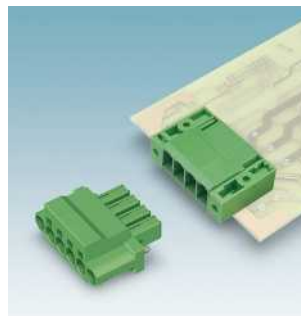

PC 5 series: plugs/headers, spring connection, up to 41 A, 7.62 mm pitch
SPC 5/... Page 530



PC 5 series: inverted plugs/headers, spring connection, up to 41 A, 7.62 mm pitch
ISPC 5/... Page 544

COMBICON power - plug-in connectors up to 6 mm² with screw and spring-cage connection

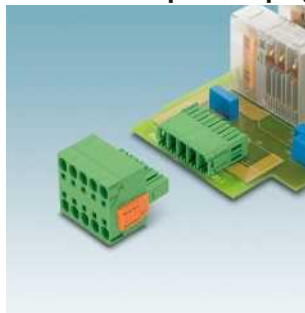

PC 5 series: plugs with double spring connection, up to 41 A, 7.62 mm pitch
TSPC 5... Page 532



PC 5 series: plugs/headers with EMC shield connection, up to 41 A
PC 5...SH... Page 525

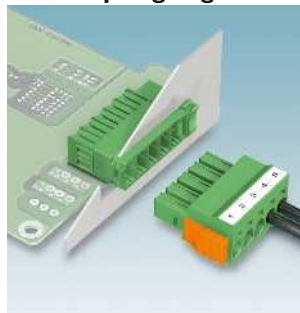

PC 5 series: feed-through headers, solder connection, up to 41 A
DFK-PC 5... Page 544

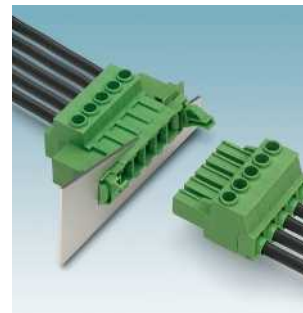

PC 5 series: feed-through headers, screw connection, up to 41 A
DFK-PC 5 Page 544

Plug-in connectors up to 16 mm² screw connection



PC 6 series: plugs/headers screw connection, up to 41 A, 10.16 mm pitch
PC 6/... Page 550



PC 6 series: plugs for direct mounting, screw connection, up to 41 A, 10.16 mm pitch
PCU 6/... Page 552

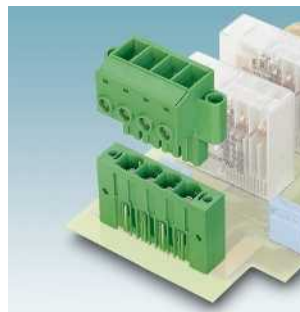

PC 16 series: plugs/headers screw connection, up to 76 A, 10.16 mm pitch
PC 16/... Page 554

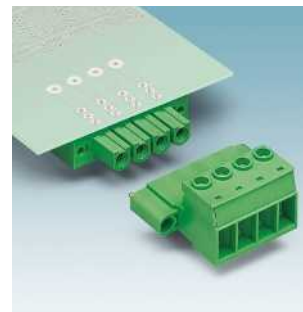

PC 16 series: inverted plugs/headers with screw connection, up to 76 A, pitch 10.16 mm
IPC 16/... Page 558

Plug-in connectors up to 16 mm² with screw and spring connection

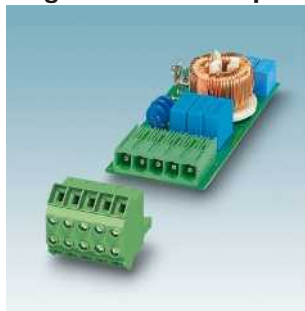

PC 16 series: plugs with double screw connection, up to 76 A, 10.16 mm pitch
TPC 16... Page 556

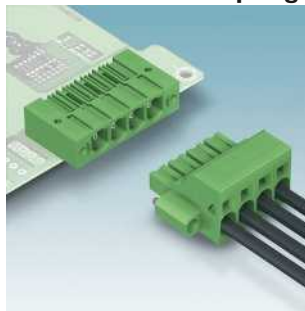

PC 16 series: plugs/headers with spring connection, up to 76 A, 10.16 mm pitch
SPC 16... Page 562

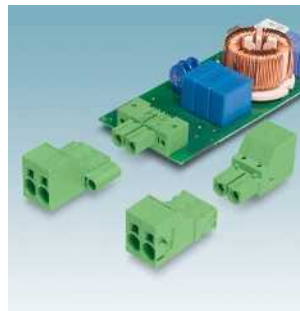

PC 16 series: inverted plugs/headers with spring connection, up to 76 A, 10.16 mm pitch
ISPC 16... Page 564

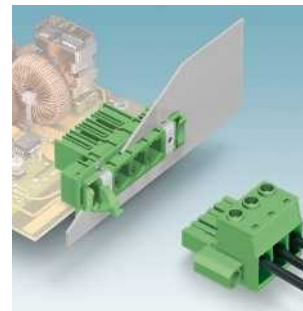

PC 16 series: feed-through headers, solder and screw connection, up to 76 A, 10.16 mm pitch
DFK-PC 16... Page 574

Plug-in connectors up to 35 mm² screw connection

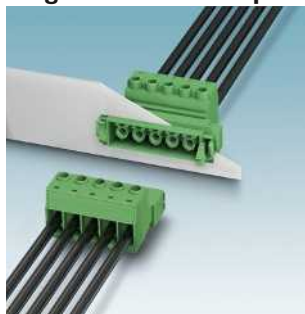

PC 16 series: inverted feed-through headers, solder and screw connection, up to 76 A, 10.16 mm pitch
DFK-IPC 16... Page 578

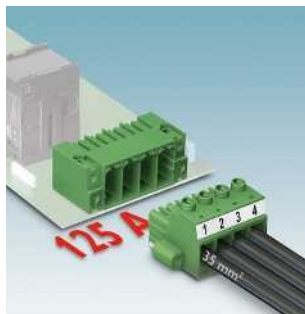

PC 35 series: plugs/headers screw connection, up to 125 A
PC 35... Page 586

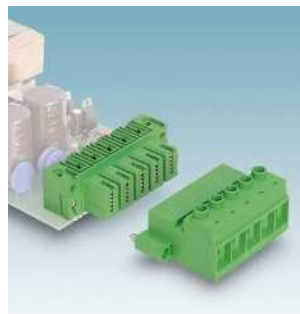

PC 35 series: inverted plugs/headers screw connection, up to 125 A
IPC 35... Page 588



PC 35 series: feed-through headers, solder connection, up to 125 A
DFK-PC 35... Page 593

Product range overview

COMBICON power - feed-through terminal blocks up to 16 mm² with fast connection technology



PW 4-POT series: push-in connection, up to 32 A with orange latch
PW 4-POT... Page 601



PWO 4-POT series: push-in connection, up to 32 A, without orange latch
PWO 4-POT... Page 603



PWO 16-POT series: push-in connection, up to 76 A, without orange latch
PWO 16-POT... Page 604



PLW 16 series: push-lock spring connection, up to 76 A outside lever, inside push-in spring
PLW 16... Page 605

Feed-through terminal blocks up to 35 mm² with screw connection



UW 4 series: screw connection, up to 41 A, connection: vertical and horizontal
UW 4... Page 607



UW 10 series: screw connection, up to 76 A, connection: vertical and horizontal
UW 10... Page 610



UW 16 series: screw connection, up to 101 A, connection: vertical and horizontal
UW 16... Page 612



UW 25 series: screw connection, up to 125 A, connection: vertical and horizontal
UW 25... Page 614

Feed-through terminal blocks up to 95 mm² with screw connection



HDFK 50 series: screw connection, up to 150 A, connection: vertical and horizontal
HDFK 50... Page 617

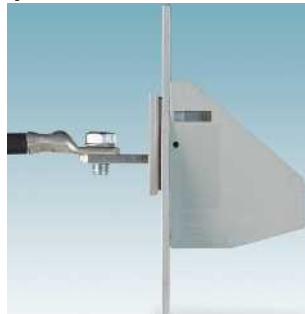

HDFK 50-VP/HDFK 95-VP series: screw connection, up to 232 A, molded terminal blocks
HDFK 50...VP... Page 619



HDFK 95 series: screw connection, up to 232 A, connection: vertical and horizontal
HDFK 95... Page 619



HDFK..TWIN series: screw connection, up to 125 A, two conductors - one potential
HDFK...TWIN Page 623

High-current feed-through terminal blocks up to 150 mm² with bolt connection



RW 5 series: bolt connection, up to 76 A, connection: vertical and horizontal
RW 5... Page 624



RW 8 series: bolt connection, up to 125 A, connection: vertical and horizontal
RW 8... Page 626

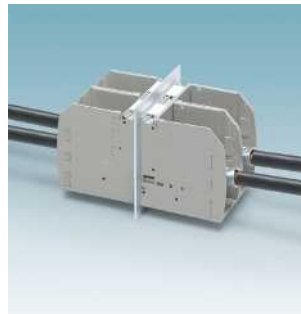

RWO 10 series: bolt connection, up to 150 A, terminal open
RWO 10... Page 636



RWO 10-TC series: bolt connection, up to 150 A, terminal transparent cover
RWO 10-TC... Page 637

Housing



Customer-specific housing solutions including connection technology Page 648

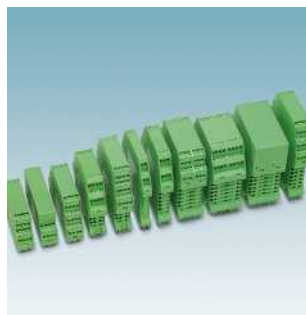

ME... component housings
Space-saving design with many additional functions Page 652

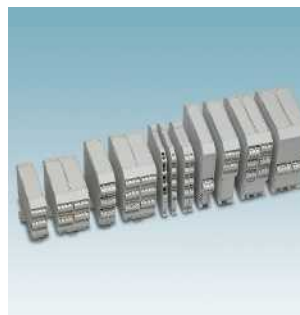

ME MAX... component housings
Large PCB surface yet compact dimensions Page 678



BC... installation component housings
Housings for installation distributors according to DIN 43880 Page 694

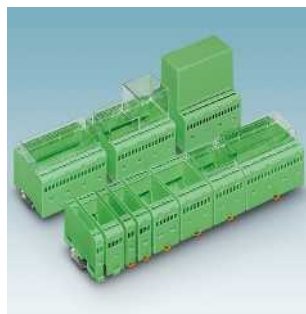

EMG... component housings
DIN rail-mountable housings in fine type scaling Page 708



EG... component housings
Receptacle housings for multiple PCB arrangements Page 718

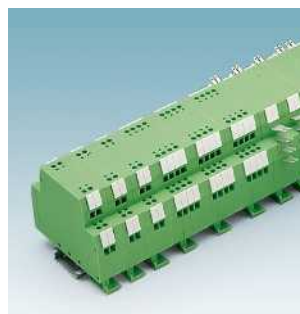

UEG... component housings
Shell housing with variable connection technologies Page 722



UEGM... component housings
Shell housing with variable connection technologies Page 724

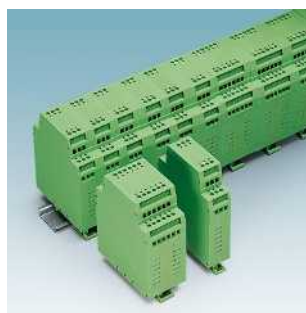

UEGH... component housings
Shell housings with two levels and variable connection technologies Page 726



ME PLC... component housings
Multifunctional housings for intelligent electronics Page 732



CM... component housings
Rugged housing range for rail-mountable power electronics Page 736



EFG 45 component housings
Half-shell housing with front plates for complex electronics Page 738



UM-ALU... panel mounting bases
Rugged profile housings for the control cabinet Page 742



UM-PRO... panel mounting bases
Profile housings for flexible electronics development Page 748



UM... panel mounting bases
Profile housings for individual PCB dimensions Page 754



HC-ALU...
Dust-tight and watertight handheld housings Page 766

Connection versatility with Phoenix Contact

Connection of your choice

Whether you choose screw, spring or insulation displacement connection technology, Phoenix Contact always provides the highest level of quality.

You can choose the worldwide standard: the versatile screw connection. This connection technology combines a large contact surface with high contact force and is a completely maintenance-free, easy, and gentle conductor connection.

Alternatively, you can also choose modern spring connection technology. Whether spring-cage or leg spring, both concepts ensure a high level of clamping reliability. In particular, leg spring systems with their short wiring times enable quick and easy connection without additional tools based on the push-in principle.

Looking for even faster wiring? Then choose the insulation displacement connection (IDC) method. The sophisticated insulation displacement or pierce connection technology ensures optimum and durable contacting.

Irrespective of whether you require a connection for signal, data or power cables, the COMBICON range offers the right terminal block for every application.

Furthermore, Phoenix Contact clamping parts are designed so that all Class 5 copper conductor types can be clamped without pretreatment.

The following pages provide an overview of the existing connection technologies and their advantages.

Screw connection with tension sleeve

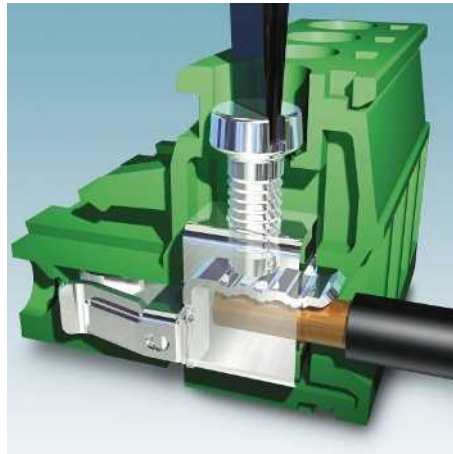

Screw connection with tension sleeve technology is the most widely used connection technology. Maximum contact force per contact surface can be achieved irrespective of the conductor cross section. Long-term stable connections can be achieved using special high-grade copper alloys, even under difficult conditions (e.g., in aggressive atmospheres). This ensures a gas-tight contact point and permanently low contact resistance. The integrated screw locking system (Reakdyn principle) prevents the loosening of the connection.

Customer benefits:

- The flat clamping part base ensures that even the thinnest connecting conductors are safely clamped (zero clamping)
- Transverse grooves in the current bar ensure that oxide film on the conductor is broken, and they provide a wrench-proof connection, which ensures good contact condition.

Areas of application:

- Applications that require high contact reliability in industrial environments

Push-in connection



The leg spring enables quick, tool-free connection of conductors. The solid conductor or a fine-strand conductor with ferrule is simply inserted into the push-in terminal point and pressed against the current bar by the leg spring.

It is only when fine-strand conductors without ferrules are connected and when this connection is released that it is necessary to actuate the opening lever, which is a feature of these terminal blocks.

Customer benefits:

- Fast connection by means of direct plug-in technology - "push-in"
- Easy operation, thanks to color-coded actuating lever
- No tools required
- Compact design

Areas of application:

- Fast wiring in the field where intuitive operation is an advantage

Spring-cage connection



Spring-cage technology enables easy connection without the need for special tools and conductor pretreatment. This spring is opened via the actuation shaft using a screwdriver and the conductor is inserted into the spring-cage via the separate conductor shaft. When the tool is removed, the spring then pulls the conductor against the power rail. This connection can be released in the same way.

Customer benefits:

- No conductor pretreatment required
- High level of contact reliability for industrial applications
- Universally used connection technology
- Time savings compared to screw connection

Areas of application:

- Fast connection technology for electronic devices

Push-in spring connection



The push-in spring combines the advantages of the leg spring with those of spring-cage technology, thereby enabling conductor connection without additional tools by means of direct plug-in technology. In addition, the fixed, predefined cage of the combined springs prevents the conductor from slipping sideways.

Therefore, the push-in spring enables, in particular, the tool-free connection of large conductor cross sections with moderate force.

Customer benefits:

- Fast connection by means of tool-free direct plug-in technology - "push-in"
- User-friendly, thanks to the protection against operating errors
- Large conductor cross sections can be connected with moderate force

Areas of application:

- Compact device connection of large conductor cross sections for fast wiring in the field.

Push-lock spring connection



The push-lock spring enables easy and tool-free conductor connection with or without ferrules by means of the "one-hand tilting lever principle".

Simply insert the solid or stranded conductor in the open terminal point and connect it reliably by actuating the tilting lever via the push-lock spring. Alternatively, conductors can also be inserted directly when the lever is closed by means of the push-in method.

Customer benefits:

- Quick and easy connection by means of the "one-hand tilting lever principle" or direct plug-in technology - "push-in"
- No conductor pretreatment required
- Intuitive operation, thanks to color-coded actuating lever
- Tool-free

Areas of application:

- Fast, easy-maintenance connection technology for the internal wiring of electronic devices and in the field.

Connection versatility with Phoenix Contact

Front screw connection



COMBICON front screw connection with pressure clip technology is a space-saving connection system from Phoenix Contact.

In the case of the COMBICON front connection, cable routing and actuation of the terminal block screw are on the same level.

Reliable clamping of the conductor is ensured by the force-increasing swiveling movement of the angled pressure plate, which is supported in the robust clamping part pocket such that it can swing freely and presses the conductor against the power rail.

Customer benefits:

- Cable routing and actuation of the terminal block screw are on the same level
- Flush cover for installation on the front of devices

Areas of application:

- Particularly suitable for PCB racks and narrow device fronts

Screw connection with wire protector

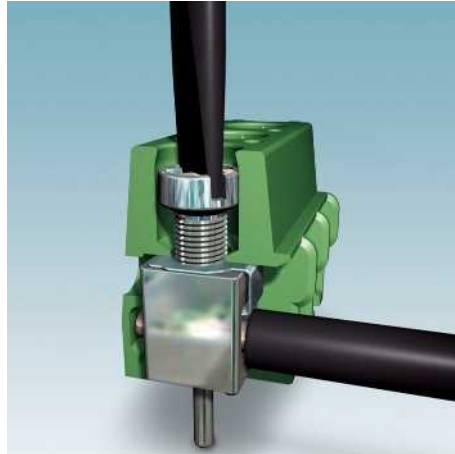

COMBICON compact with wire protector technology is the PCB terminal block and plug-in connector range from Phoenix Contact for semi-industrial applications. Therefore, the same quality requirements are placed on the COMBICON compact product range as those for the industrial COMBICON product range.

However, the PCB connection technology of COMBICON compact has been greatly simplified in some areas and adapted to the conditions of building technology.

Customer benefits:

- Highly flexible wire protector
- Large rectangular clamping spaces
- Suitable for terminal connections up to a conductor cross section of 4 mm²

Areas of application:

Building technology, safety technology, telecommunications, etc.

Insulation displacement connection (IDC)



Reliable contacting using IDC (insulation displacement connection) connection technology is achieved by inserting the conductor into the specially designed cutting metal.

This method centers the conductor and cuts open the insulation in the cutting zone, thereby creating a reliable connection between the conductor and cutting metal. This connection technology is suitable for cables with PVC and PE insulation.

Eliminating cable preparation, such as stripping and the fitting of splicing protection, results in significant time savings of up to 60% compared to conventional connection technologies.

Customer benefits:

- Particularly time-saving connection technology
- Stripping and the fitting of splicing protection is not required
- No special tools required

Areas of application:

- Installation applications where a variety of conductors with similar cross sections must be connected in a short amount of time
- Field installation, since only minimal tools are needed for connection and conductor pretreatment is not required

Crimp connection



The crimp connection technology enables fast, cost-effective connection for cables that have to be assembled in large volumes.

The wire/crimp contact connection is established using crimping pliers or a crimping machine.

Taped crimp contacts are available for fully automated processing.

The crimp plugs in the various plug-in connector series can be used in combination with virtually all headers.

Customer benefits:

- Variable production run startup, thanks to fully or semi-automatic machine
- High tensile strength for the connection
- Low contact resistance
- Easy production monitoring
- High resistance to ambient conditions, vibration, and shock

Areas of application:

- Crimp connections are the ideal connection system for harsh ambient conditions, such as extreme temperature change, vibration and shock, and aggressive atmospheres

Pierce connection

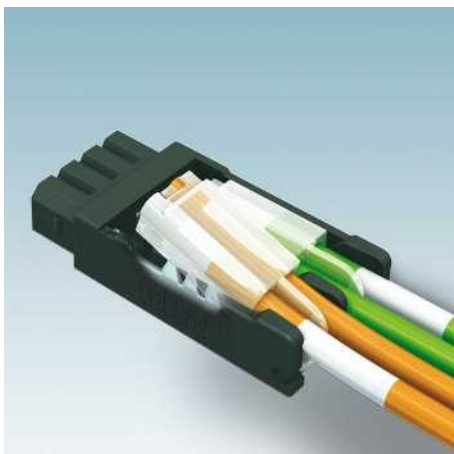

Pierce connection is a reliable connection technology that does not require conductor pretreatment. Contact is made by inserting the conductors in the corresponding guide in the transparent cover of the plug-in connector. When the cover is closed, the pierce contacts pierce through the conductor insulation and so ensure a durable conductor connection.

Customer benefits:

- Time-saving connection technology
- Stripping and the fitting of ferrules is not required
- No special tools required
- Conductors can be easily released by opening the cover

Areas of application:

- Easy field installation, since conductor pretreatment and special tools are not required

Bolt connection

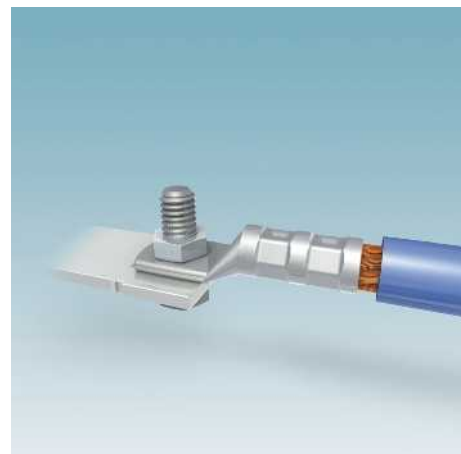

Bolt connection technology has been developed with a robust design and for the convenient wiring of ring cable lugs.

The ring cable lug is simply placed on the bolt and secured in place with the nut. The captive nut is connected to a hinged cover flap. This means that ring cable lugs can be connected quickly and easily.

The integrated screw locking in the form of a spring retainer guarantees safe use, even in applications which are subject to shock and vibration.

Customer benefits:

- Quick and easy ring cable lug wiring
- Conductors up to 150 mm² can be wired securely and with long-term stability
- Easy multi-conductor connection, up to four cable lugs can be connected per bolt

Areas of application:

- Applications which require ring cable lugs to be connected quickly and easily