



Chipsmall Limited consists of a professional team with an average of over 10 year of expertise in the distribution of electronic components. Based in Hongkong, we have already established firm and mutual-benefit business relationships with customers from,Europe,America and south Asia,supplying obsolete and hard-to-find components to meet their specific needs.

With the principle of “Quality Parts,Customers Priority,Honest Operation,and Considerate Service”,our business mainly focus on the distribution of electronic components. Line cards we deal with include Microchip,ALPS,ROHM,Xilinx,Pulse,ON,Everlight and Freescale. Main products comprise IC,Modules,Potentiometer,IC Socket,Relay,Connector.Our parts cover such applications as commercial,industrial, and automotives areas.

We are looking forward to setting up business relationship with you and hope to provide you with the best service and solution. Let us make a better world for our industry!



Contact us

Tel: +86-755-8981 8866 Fax: +86-755-8427 6832

Email & Skype: info@chipsmall.com Web: www.chipsmall.com

Address: A1208, Overseas Decoration Building, #122 Zhenhua RD., Futian, Shenzhen, China





Power Transformer - Dual Primary Low Voltage PC Board Mount - Low Profile

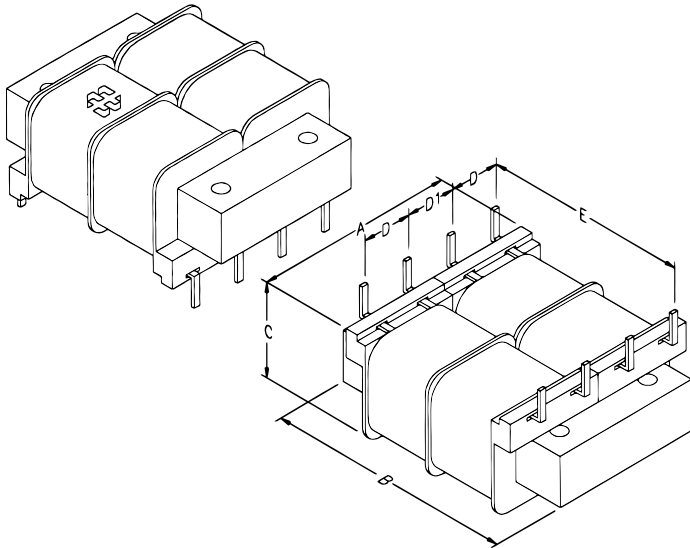

Features

- Low profile mounting, dual - split bobbin design.
- Low primary to secondary coupling, balanced windings, no electrostatic shield required and low EMF radiation due to semi-toroidal design.
- Universal dual primary 115/230V - 50/60 Hz.
- High insulation - Hipot of 1,750V RMS.
- Class B insulation - 130 degrees C.
- C UL US recognized.

Connection Information - 229 Series Transformers

Mechanical	
A	1.56" (40 mm)
B	1.88" (48 mm)
C	0.85" (22 mm)
D	0.38" (10 mm)
D1	0.38" (10 mm)
E	1.60" (41 mm)
PC Board Spacing	1.00" (25 mm)
Pin Size	0.02" x 0.04" (1 mm x 1 mm)
Electrical	
Size (VA)	6
Primary	115 /230V, 50 /60Hz
Secondary (RMS) Series	40V C.T. @ 150ma
Secondary (RMS) Parallel	20V @ 300ma
Regulation	30%

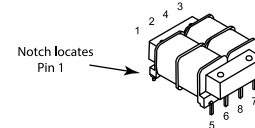

Primary Connections - 229 Series Transformers

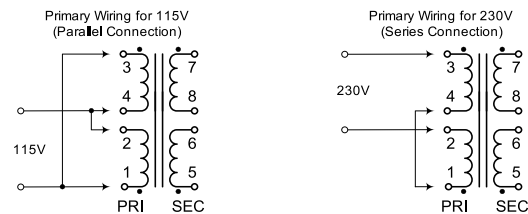

Secondary Connections - 229 Series Transformers

