



Chipsmall Limited consists of a professional team with an average of over 10 year of expertise in the distribution of electronic components. Based in Hongkong, we have already established firm and mutual-benefit business relationships with customers from,Europe,America and south Asia,supplying obsolete and hard-to-find components to meet their specific needs.

With the principle of “Quality Parts,Customers Priority,Honest Operation,and Considerate Service”,our business mainly focus on the distribution of electronic components. Line cards we deal with include Microchip,ALPS,ROHM,Xilinx,Pulse,ON,Everlight and Freescale. Main products comprise IC,Modules,Potentiometer,IC Socket,Relay,Connector.Our parts cover such applications as commercial,industrial, and automotives areas.

We are looking forward to setting up business relationship with you and hope to provide you with the best service and solution. Let us make a better world for our industry!



Contact us

Tel: +86-755-8981 8866 Fax: +86-755-8427 6832

Email & Skype: info@chipsmall.com Web: www.chipsmall.com

Address: A1208, Overseas Decoration Building, #122 Zhenhua RD., Futian, Shenzhen, China



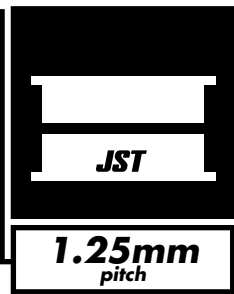

JED CONNECTOR

Board-to-board connectors

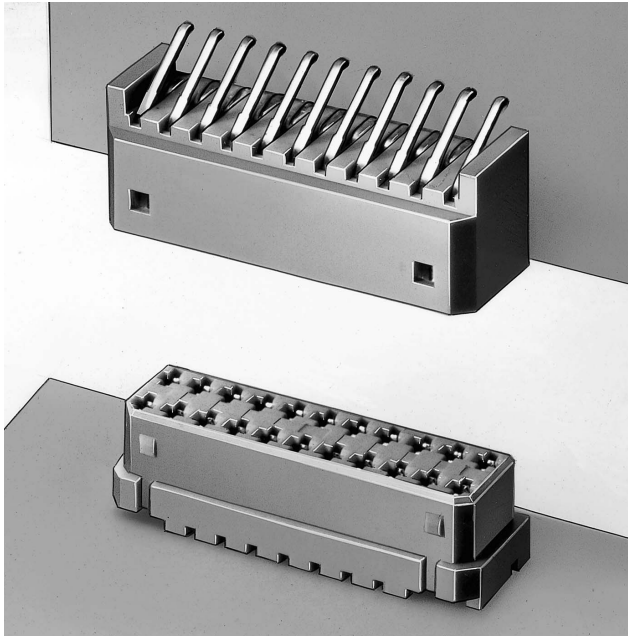

This 1.25mm pitch dual-in-line, board-to-board connector. Double-sided, high-pressure contacts and a housing locking feature provide reliable connections.

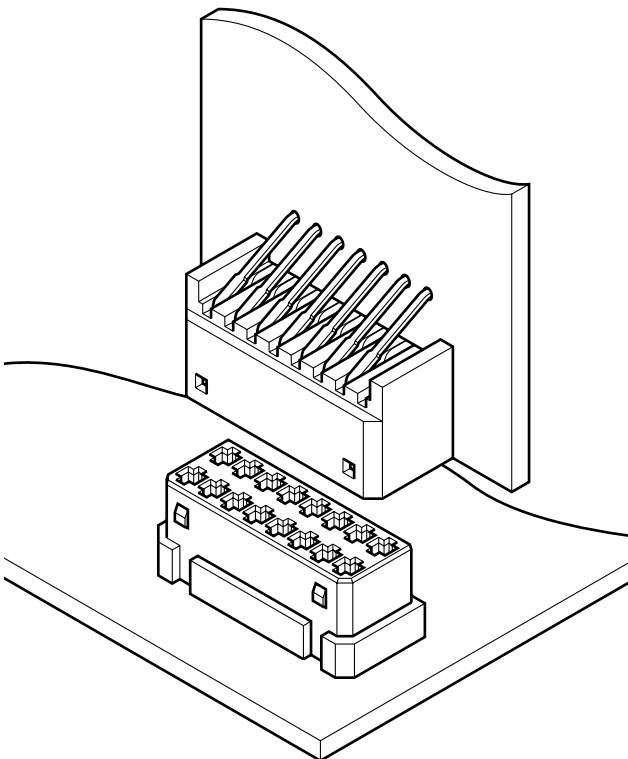

Feature

• A compact design to meet today's needs

This small connector has a 1.25mm pitch dual-in-line construction at both the mating and printed circuit board sides. It has a mounting height of only 7.0mm and a thickness of 4.6mm.

• Positive housing lock provides a highly reliable connection

The high-pressure, double-sided, fork type contacts and a housing lock feature ensure continuity even when the connector is subjected to severe vibration or shock.

• Polarized shrouded header

The polarized shrouded header prevents misinsertion or distortion of the receptacle housing during mating. The rigid mating between the plug and receptacle guarantees high reliability during vibration or shock.

Specifications

- Current rating: 1.0A AC, DC
- Voltage rating: 50V AC, DC
- Temperature range: -25°C to +85°C
(including temperature rise in applying electrical current)
- Contact resistance: Initial value/20m Ω max.
After environmental testing/40m Ω max.
- Insulation resistance: 300M Ω min.
- Withstanding voltage: 500V AC/minute
- Applicable PC board thickness: 0.8 to 1.0mm
- * Compliant with RoHS.
- * Refer to "General Instruction and Notice when using Terminals and Connectors" at the end of this catalog.
- * Contact JST for details.

Standards

 Recognized E60389

 Certified LR20812

JED CONNECTOR

Plug

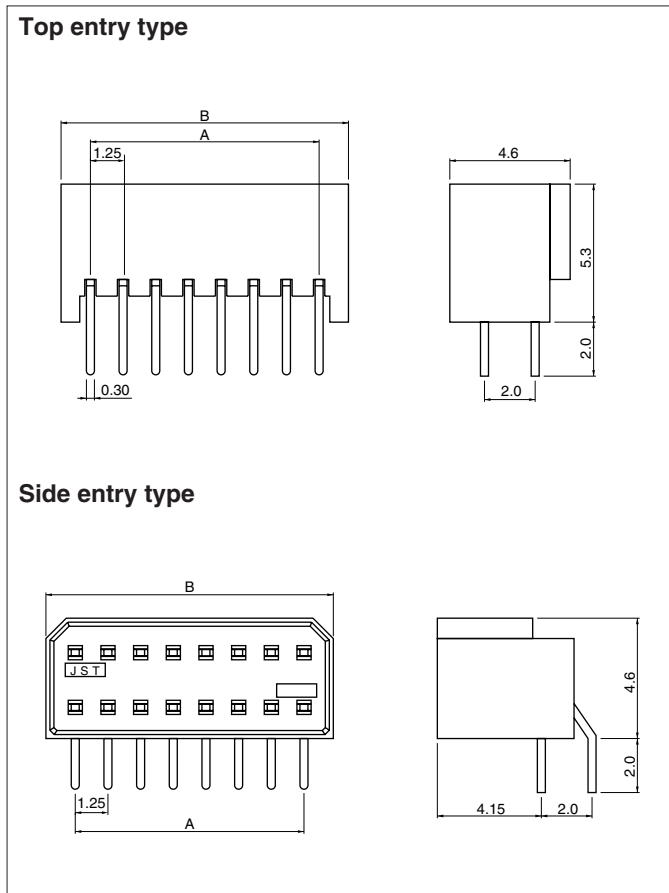

Circuits	Model No.		Dimensions (mm)		Q'ty / box
	Top entry type	Side entry type	A	B	
8	08P-JED	08PS-JED	3.75	5.95	500
16	16P-JED	16PS-JED	8.75	10.95	500
22	22P-JED	22PS-JED	12.50	14.70	500

Material and Finish

Contact: Brass, tin-plated(reflow treatment)
Housing: Glass-filled PA 66, UL94V-0

RoHS compliance

Receptacle

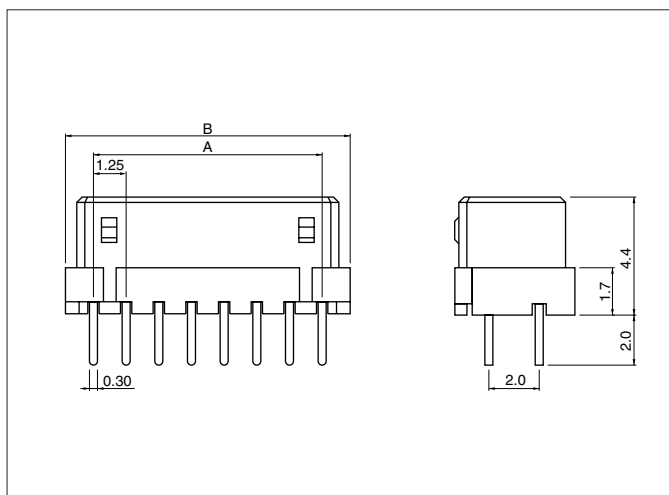

Circuits	Model No.	Dimensions (mm)		Q'ty / box
		A	B	
8	08R-JED	3.75	5.95	500
16	16R-JED	8.75	10.95	500
22	22R-JED	12.50	14.70	500

Material and Finish

Contact: Phosphor bronze, copper-undercoated, tin-plated(reflow treatment)
Housing: Glass-filled PA 66, UL94V-0

RoHS compliance This product displays (LF)(SN) on a label.

PC board layout (viewed from soldering side)

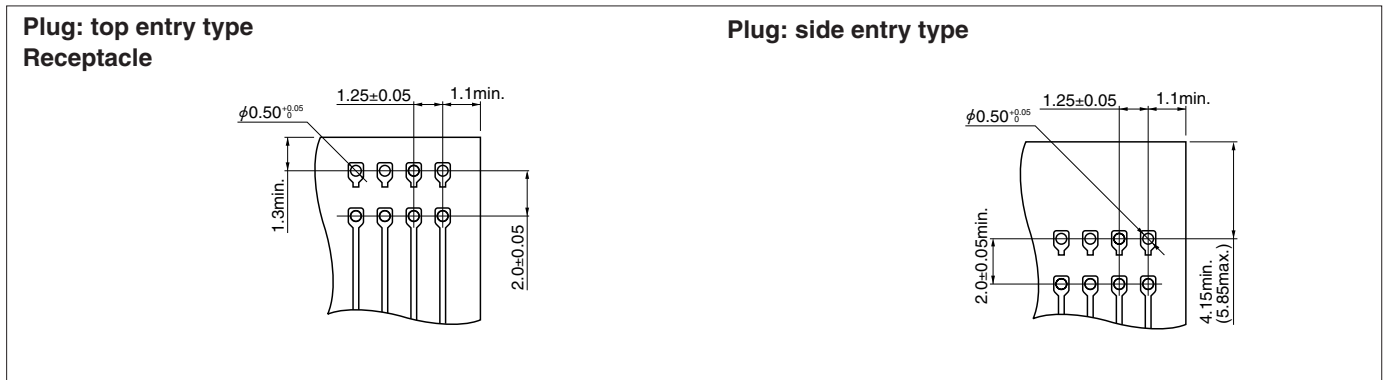

Note:

1. Tolerances are non-cumulative: $\pm 0.05\text{mm}$ for all centers.
2. Hole dimensions differ according to the kind of PC board and piercing method. The dimensions above should serve as a guideline.

Assembly layout

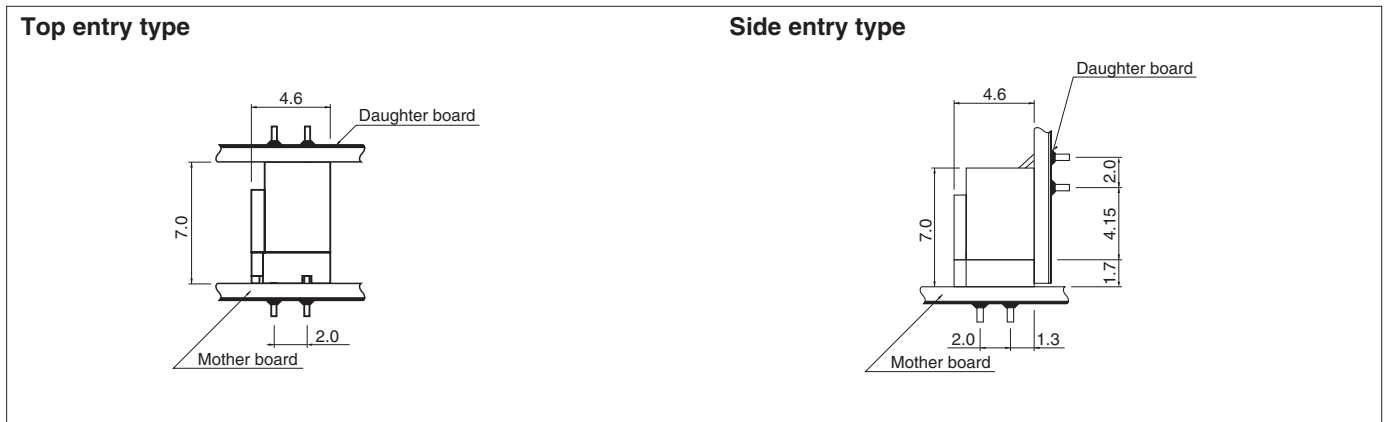

- Note:** The daughter board must be secured by means other than the connector.
Contact JST for more details.