



Chipsmall Limited consists of a professional team with an average of over 10 year of expertise in the distribution of electronic components. Based in Hongkong, we have already established firm and mutual-benefit business relationships with customers from,Europe,America and south Asia,supplying obsolete and hard-to-find components to meet their specific needs.

With the principle of "Quality Parts,Customers Priority,Honest Operation,and Considerate Service",our business mainly focus on the distribution of electronic components. Line cards we deal with include Microchip,ALPS,ROHM,Xilinx,Pulse,ON,Everlight and Freescale. Main products comprise IC,Modules,Potentiometer,IC Socket,Relay,Connector.Our parts cover such applications as commercial,industrial, and automotives areas.

We are looking forward to setting up business relationship with you and hope to provide you with the best service and solution. Let us make a better world for our industry!



## Contact us

Tel: +86-755-8981 8866 Fax: +86-755-8427 6832

Email & Skype: info@chipsmall.com Web: www.chipsmall.com

Address: A1208, Overseas Decoration Building, #122 Zhenhua RD., Futian, Shenzhen, China



# User Manual

## VME / VME64x Backplanes

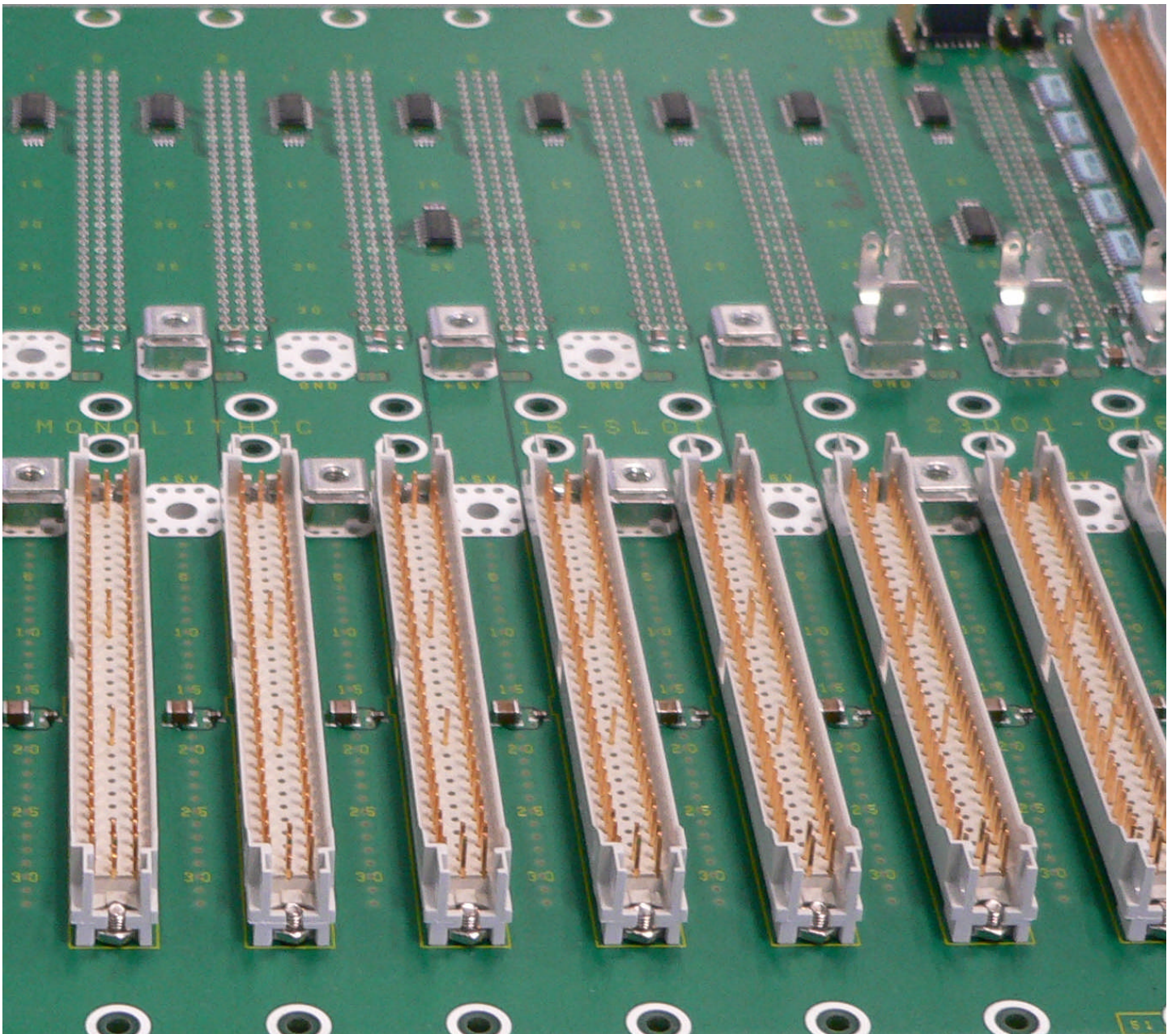

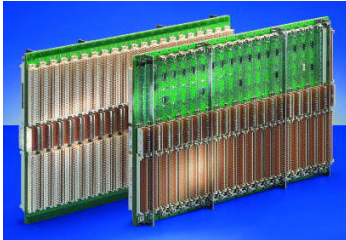
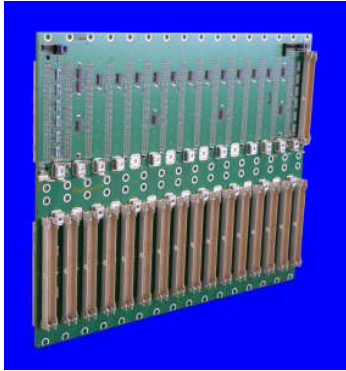

## What is VMEbus

The VMEbus started with the ANSI/VITA 1 specification in 1982. The original specification was sponsored by VITA and eventually standardized as IEEE 1014. It established a framework for 8-, 16- and 32-bit parallel-bus computer architectures that can implement single and multiprocessor systems. This bus includes the initial four basic subbuses: data transfer bus, priority interrupt bus, arbitration bus, and utility bus. Other architectures with other subbuses are possible within this VME framework.

In 1994, VME64 was formally approved by ANSI as ANSI/VITA 1-1994, incorporating all the features of VME32 and adding support for 64-bit transfers.

In 1998, the VME64 Extensions were officially approved as ANSI/VITA 1.1-1997. This standard is an extension of the ANSI/VITA 1-1994, VME64 Standard. It defines a set of features that can be added to VME and VME64 boards, backplanes and subracks. These features include a 160 pin connector (the 5-row DIN instead of the previous 3-row DIN), a P0 connector, geographical addressing, voltage pins for 3.3V, a test and maintenance bus, EMI, ESD, front panel handles and keying per IEEE 1101.10.

ANSI/VITA 1.5 is an extension of the ANSI/VITA 1-1994, VME64 and ANSI/VITA 1.1-1997, VME64x standards. It extends performance by adding dual edge, source synchronous data transfer (2eSST) capability that allows sustained data transfers in excess of 300MB/sec.

ANSI/VITA 1.7 defines higher currents (2A) for the voltage pins on VME / VME64x equipment, ANSI/VITA 3 implements life insertion at VME64x boards and ANSI/VITA 38 finally adds system management features to the VME64x environment.

## What is VITA

VITA, the VMEbus International Trade Association, is an incorporated, non-profit organization of vendors and users having a common market interest in real-time, modular embedded computing systems. Accredited as an American National Standards Institute (ANSI) developer and a submitter of Industry Trade Agreements to the IEC, the VITA Standards Organization provides its members with the ability to develop and to promote open technology standards.

## VME / VME64x Backplanes

### J1 Backplane

The basic configuration is the 3U high (Single Eurocard) J1 plane. This plane provides all the address, data and control lines, and is fully capable of operating as a standalone bus.

### J2 Backplane

For larger computer structures, the basic configuration can be extended with a second plane, the J2 plane, also 3U high. It's located directly below the J1 plane in the 19-inch rack and extends the data and address space of the computer system. In addition, the user is provided with 64 freely-definable inputs/outputs per slot, which can be connected using interconnection points on the rear of the backplane. The J2 plane is only used as an extension of the VMEbus from the J1-plane and cannot be operated as a standalone bus.

### J1/J2 Monolithic Backplane

Monolithic backplanes combine the J1 and J2 planes on a single printed circuit board. Because of its continuous power supply layer, the monolithic backplane is superior to two separate J1 and J2 planes, particularly with respect to dynamic current distribution.

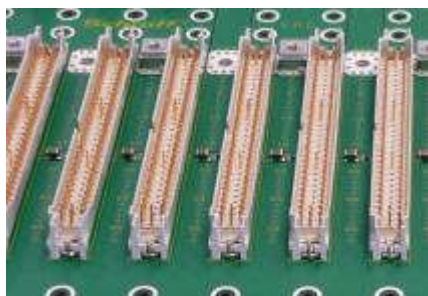
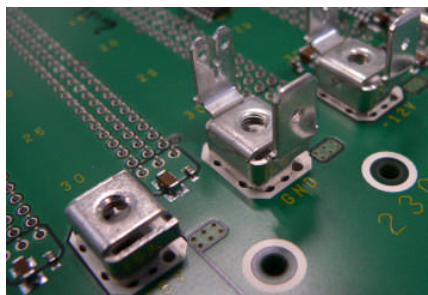
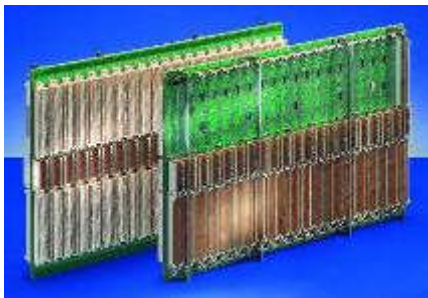

## Schroff VME / VME64x Backplanes

Schroff VME / VME64x backplanes are fully compliant to the latest VITA specifications.

ANSI / VITA 1-1994	VME64 Specification
ANSI / VITA 1.1-1997	VME64x Specification
ANSI / VITA 1.5-2003	VME2eSST Specification, VME64 and VME64x
ANSI / VITA 1.7-2003	Increased Current Level
ANSI / VITA 3-1995	Live Insertion System Requirements
ANSI / VITA 38-2003	System Management Specification

Schroff VME / VME64x backplanes are specially designed to achieve excellent power distribution, best signal integrity and virtually zero cross talk. The SMD components used on Schroff VME / VME64x backplanes lead to a much lower failure rate than conventional components.

Schroff uses ceramic capacitors on the VME / VME64x backplanes to gain a better noise reduction at frequencies above 10MHz. This feature reduces the radiated and conducted noise caused by the processor clock signals. In addition, ceramic capacitors have no limitation in useful lifetime, as compared to aluminium capacitors that dry out after 5 to 10 years, and are unaware of the hazardous fire risks known from tantalum electrolytics.

## Schroff VME / VME64x Backplane Features

### Isolated Assembling / Connection to ChassisGND

Schroff VME / VME64x backplanes have a specially designed pattern of mounting holes to assemble the backplane isolated or connected to ChassisGND.

For isolation between BackplaneGND and ChassisGND M2.5 screws and isolating washers should be used in at least every second connector position.

If noise reduction shall be achieved by connecting BackplaneGND to ChassisGND conductive spring washers are recommended instead of isolating ones.

### Power Input

Schroff VME / VME64x backplanes are populated with specially designed power bugs. The power cables can be connected to the power bugs with cable lugs fastened with M4 screws. Each power bug can handle 30 Amps.

+5V Stdby input is realized with a faston terminal.

### Shrouds

Schroff VME / VME64x backplanes have long pins on the I/O positions and shrouds on all J2 positions and on 1J1. All other J1 positions have short pins. The long tails are gold plated.

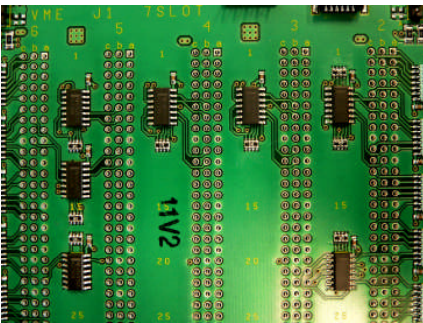
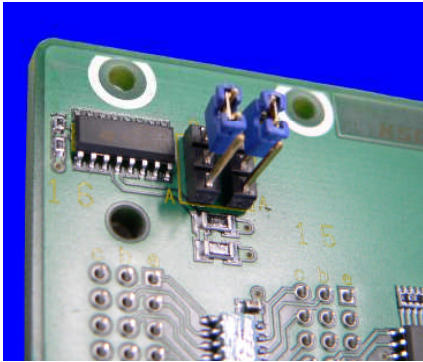

## Special Features of Schroff VME Backplanes

Schroff is offering VME J1, J2 and J1/J2 monolithic backplanes.

### Termination

Schroff VMEbus backplanes come with a passive inboard termination in the J2 area and with both, active and passive inboard termination, at J1. Active or passive termination can be selected with a jumper field at each upper end of the backplane.

While the current consumption in non-operating mode is around 1,5A on a passive J1 backplane, the active termination reduces the current consumption of the backplane to 20mA.

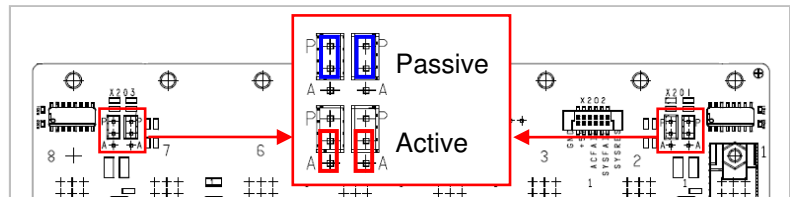

### Daisy Chain

By default, Schroff VMEbus backplanes with more than 2 Slots are equipped with Electric Automatic Daisy Chain.

Electric Automatic Daisy Chain (EDC) is achieved by integrated circuits with „or“ logic. When the daughter card is removed, the logic closes the chain.

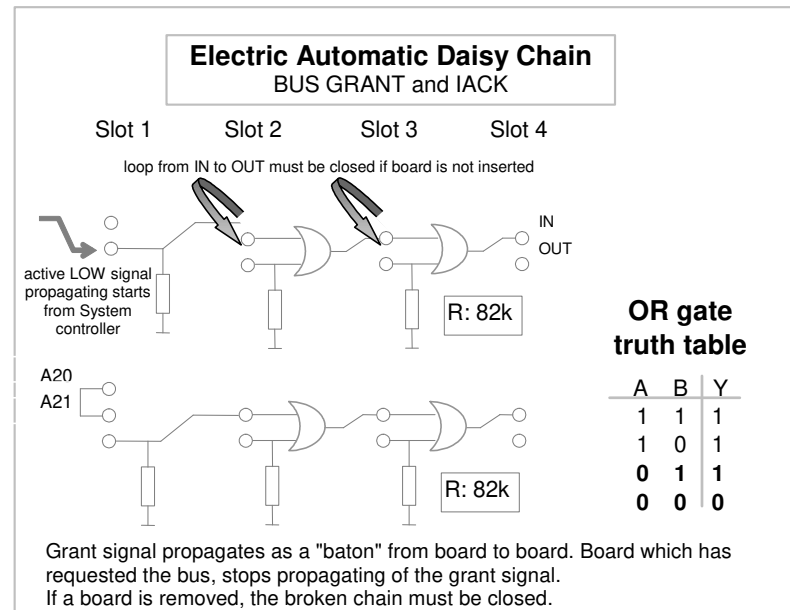

**Automatic Daisy Chain (ADC)**, realized by a special connector with mechanical switches inside. This option is available on request.

**Manual Daisy Chain (MDC)**, closes the connections by jumper pins. This option is available on request. Realized with a special C-96 J1 connector with long tails on the daisy chain pins, where the required connections can be made with jumpers.

### Latchable Shrouds

The shroud used on Schroff VME backplanes is prepared to accept optional latches. Two different latches are available, please refer to chapter „article numbers“, table accessories.

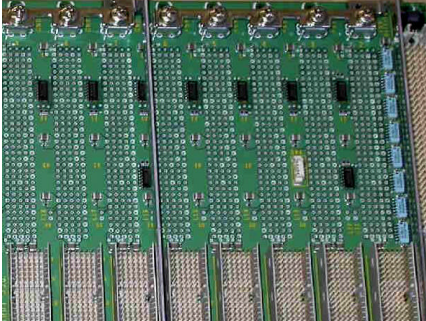

## Special Features of Schroff VME64x backplanes

Schroff is offering VME64x J1/J2 monolithic backplanes.

### Termination

Schroff VME64x backplanes come with a passive inboard termination.

### Daisy Chain

Schroff VME64x backplanes with more than 2 Slots are equipped with Electric Automatic Daisy Chain.

Electric Automatic Daisy Chain (EDC) is achieved by integrated circuits with „or“ logic. When the daughter card is extracted, the logic closes the chain.

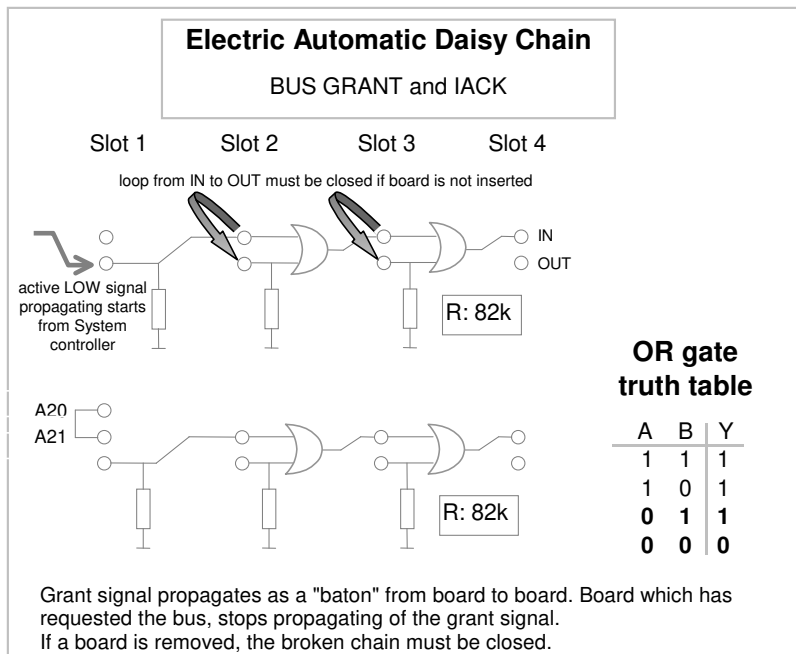

### Mechanical Stability

As the VME64x specification has implemented the P0 connector between the J1 and J2 area, there is no possibility of mounting the backplane to a horizontal centre profile. To prevent the bending of the 6U VME64x backplane during insertion and extraction of the daughter boards, the Schroff VME64x backplanes are equipped with Stiffeners.

### Live Insertion

Schroff VME64x backplanes fulfil the requirements of the VME Live Insertion standard VITA 3. The LI/I\* (Live Insertion IN) is an active low input signal to a VME64x LI board that acts to enable/disable the on-board power control logic. A set of two pins per slot for LI/I\* and GND spaced by 100mil is optional available to connect the signal to a radial power control module.

**Connectors on Schroff VME / VME64x Backplanes**

**Pin Assignment VME / VME64x Connectors**

**Table 1: VME64 J1/P1 Connector Pin Assignment**

Pin	Z	A	B	C	D
1	Reserved	D00	BBSY*	D08	Reserved
2	GND	D01	BCLR*	D09	Reserved
3	Reserved	D02	ACFAIL*	D10	Reserved
4	GND	D03	BG0IN*	D11	Reserved
5	Reserved	D04	BG0OUT*	D12	Reserved
6	GND	D05	BG1IN*	D13	Reserved
7	Reserved	D06	BG1OUT*	D14	Reserved
8	GND	D07	BG2IN*	D15	Reserved
9	Reserved	GND	BG2OUT*	GND	Reserved
10	GND	SYSCLK	BG3IN*	SYSFAIL*	Reserved
11	Reserved	GND	BG3OUT*	BERR*	Reserved
12	GND	DS1*	BR0*	SYSRESET*	Reserved
13	Reserved	DS0*	BR1*	LWORD*	Reserved
14	GND	WRITE*	BR2*	AM5	Reserved
15	Reserved	GND	BR3*	A23	Reserved
16	GND	DTACK*	AM0	A22	Reserved
17	Reserved	GND	AM1	A21	Reserved
18	GND	AS*	AM2	A20	Reserved
19	Reserved	GND	AM3	A19	Reserved
20	GND	IACK*	GND	A18	Reserved
21	Reserved	IACKIN*	SERA	A17	Reserved
22	GND	IACKOUT*	SERB	A16	Reserved
23	Reserved	AM4	GND	A15	Reserved
24	GND	A07	IRQ7*	A14	Reserved
25	Reserved	A06	IRQ6*	A13	Reserved
26	GND	A05	IRQ5*	A12	Reserved
27	Reserved	A04	IRQ4*	A11	Reserved
28	GND	A03	IRQ3*	A10	Reserved
29	Reserved	A02	IRQ2*	A09	Reserved
30	GND	A01	IRQ1*	A08	Reserved
31	Reserved	-12V	+5VSTDBY	+12V	Reserved
32	GND	+5V	+5V	+5V	Reserved
Pin	Z	A	B	C	D

**Note:** (\*) These signals are active LOW  
 (1) Rows z and d are optional, not present on Schroff VME backplanes

**Table 2: VME64 J2/P2 Connector Pin Assignment**

Pin	Z	A	B	C	D
1	Reserved	User Defined	+5V	User Defined	Reserved
2	GND	User Defined	GND	User Defined	Reserved
3	Reserved	User Defined	RETRY*	User Defined	Reserved
4	GND	User Defined	A24	User Defined	Reserved
5	Reserved	User Defined	A25	User Defined	Reserved
6	GND	User Defined	A26	User Defined	Reserved
7	Reserved	User Defined	A27	User Defined	Reserved
8	GND	User Defined	A28	User Defined	Reserved
9	Reserved	User Defined	A29	User Defined	Reserved
10	GND	User Defined	A30	User Defined	Reserved
11	Reserved	User Defined	A31	User Defined	Reserved
12	GND	User Defined	GND	User Defined	Reserved
13	Reserved	User Defined	+5V	User Defined	Reserved
14	GND	User Defined	D16	User Defined	Reserved
15	Reserved	User Defined	D17	User Defined	Reserved
16	GND	User Defined	D18	User Defined	Reserved
17	Reserved	User Defined	D19	User Defined	Reserved
18	GND	User Defined	D20	User Defined	Reserved
19	Reserved	User Defined	D21	User Defined	Reserved
20	GND	User Defined	D22	User Defined	Reserved
21	Reserved	User Defined	D23	User Defined	Reserved
22	GND	User Defined	GND	User Defined	Reserved
23	Reserved	User Defined	D24	User Defined	Reserved
24	GND	User Defined	D25	User Defined	Reserved
25	Reserved	User Defined	D26	User Defined	Reserved
26	GND	User Defined	D27	User Defined	Reserved
27	Reserved	User Defined	D28	User Defined	Reserved
28	GND	User Defined	D29	User Defined	Reserved
29	Reserved	User Defined	D30	User Defined	Reserved
30	GND	User Defined	D31	User Defined	Reserved
31	Reserved	User Defined	GND	User Defined	Reserved
32	GND	User Defined	+5V	User Defined	Reserved
Pin	Z	A	B	C	D

(1) Rows z and d are optional, not present on Schroff VME backplanes



Table 3: VME64x J1/P1 Connector Pin Assignment

Pin	Z	A	B	C	D
1	MPR	D00	BBSY*	D08	VPC (1)
2	GND	D01	BCLR*	D09	GND (1)
3	MCLK	D02	ACFAIL*	D10	+V1
4	GND	D03	BG0IN*	D11	+V2
5	MSD	D04	BG0OUT*	D12	RsvU
6	GND	D05	BG1IN*	D13	-V1
7	MMD	D06	BG1OUT*	D14	-V2
8	GND	D07	BG2IN*	D15	RsvU
9	MCTL	GND	BG2OUT*	GND	GAP*
10	GND	SYSCLK	BG3IN*	SYSFAIL*	GA0*
11	RESP*	GND	BG3OUT*	BERR*	GA1*
12	GND	DS1*	BR0*	SYSRESET*	+3.3V
13	RsvBus	DS0*	BR1*	LWORD*	GA2*
14	GND	WRITE*	BR2*	AM5	+3.3V
15	RsvBus	GND	BR3*	A23	GA3*
16	GND	DTACK*	AM0	A22	+3.3V
17	RsvBus	GND	AM1	A21	GA4*
18	GND	AS*	AM2	A20	+3.3V
19	RsvBus	GND	AM3	A19	SMB_SCL <sup>(2)</sup>
20	GND	IACK*	GND	A18	+3.3V
21	RsvBus	IACKIN*	IPMB_SCL <sup>(2)</sup>	A17	SMB_SDA <sup>(2)</sup>
22	GND	IACKOUT*	IPMB_SDA <sup>(2)</sup>	A16	+3.3V
23	RsvBus	AM4	GND	A15	SMB_ALERT# <sup>(2)</sup>
24	GND	A07	IRQ7*	A14	+3.3V
25	RsvBus	A06	IRQ6*	A13	RsvBus
26	GND	A05	IRQ5*	A12	+3.3V
27	RsvBus	A04	IRQ4*	A11	LI/I*
28	GND	A03	IRQ3*	A10	+3.3V
29	RsvBus	A02	IRQ2*	A09	LI/O*
30	GND	A01	IRQ1*	A08	+3.3V
31	RsvBus	-12V	+5VSTBY	+12V	GND <sup>(1)</sup>
32	GND	+5V	+5V	+5V	VPC <sup>(1)</sup>
Pin	Z	A	B	C	D

**Note:** (1) These pins are MFBL (mate-first-break-last) pins  
 (2) System management signals (IPMB..., SMB\_...) introduced with VITA 38  
 (\*) These signals are active LOW

**Table 4: VME64x J2/P2 Connector Pin Assignment**

Pin	Z	A	B	C	D
1	User Defined	User Defined	+5V	User Defined	User Defined <sup>(1)</sup>
2	GND	User Defined	GND	User Defined	User Defined <sup>(1)</sup>
3	User Defined	User Defined	RETRY*	User Defined	User Defined
4	GND	User Defined	A24	User Defined	User Defined
5	User Defined	User Defined	A25	User Defined	User Defined
6	GND	User Defined	A26	User Defined	User Defined
7	User Defined	User Defined	A27	User Defined	User Defined
8	GND	User Defined	A28	User Defined	User Defined
9	User Defined	User Defined	A29	User Defined	User Defined
10	GND	User Defined	A30	User Defined	User Defined
11	User Defined	User Defined	A31	User Defined	User Defined
12	GND	User Defined	GND	User Defined	User Defined
13	User Defined	User Defined	+5V	User Defined	User Defined
14	GND	User Defined	D16	User Defined	User Defined
15	User Defined	User Defined	D17	User Defined	User Defined
16	GND	User Defined	D18	User Defined	User Defined
17	User Defined	User Defined	D19	User Defined	User Defined
18	GND	User Defined	D20	User Defined	User Defined
19	User Defined	User Defined	D21	User Defined	User Defined
20	GND	User Defined	D22	User Defined	User Defined
21	User Defined	User Defined	D23	User Defined	User Defined
22	GND	User Defined	GND	User Defined	User Defined
23	User Defined	User Defined	D24	User Defined	User Defined
24	GND	User Defined	D25	User Defined	User Defined
25	User Defined	User Defined	D26	User Defined	User Defined
26	GND	User Defined	D27	User Defined	User Defined
27	User Defined	User Defined	D28	User Defined	User Defined
28	GND	User Defined	D29	User Defined	User Defined
29	User Defined	User Defined	D30	User Defined	User Defined
30	GND	User Defined	D31	User Defined	User Defined
31	User Defined	User Defined	GND	User Defined	GND <sup>(1)</sup>
32	GND	User Defined	+5V	User Defined	VPC <sup>(1)</sup>
Pin	Z	A	B	C	D

**Note:** (1) These pins are MFBL (mate-first-break-last) pins

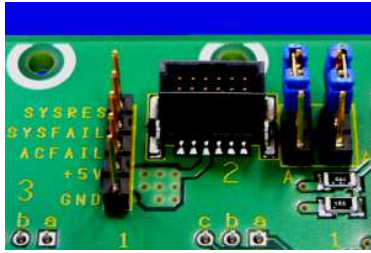

**Additional Connectors on Schroff VME / VME64x Backplanes**

**Utility Connectors**

12-pin fine-pitch connector, assembled on all Schroff VME64x and below mentioned VME backplanes

**23001-007, 23001-012, 23001-076, 23001-080**

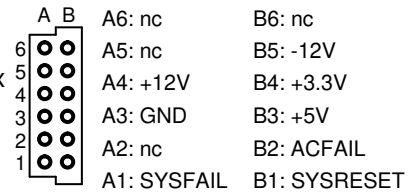

8-pin connector, pitch 2.54mm, assembled on all J1 and monolithic VME backplanes other than described above

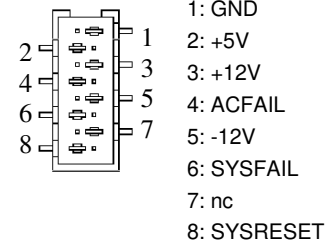

5-pin connector, pitch 2.54mm, assembled on the Schroff VME J1 and monolithic backplanes

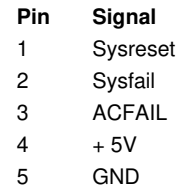

**IPMB Connector, VME64x Backplanes only**

According to ANSI / VITA 38-2003, System Management Specification.

Vsm is connected to +5V Standby

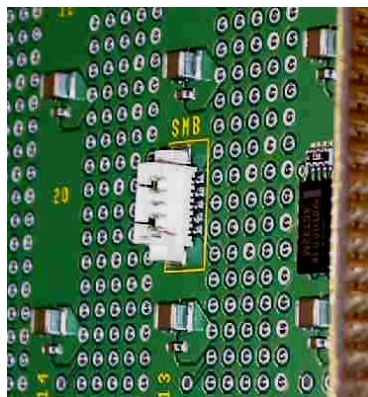
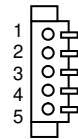
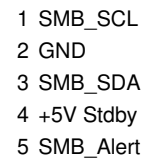

**V1 / V2 Connector, VME64x Backplanes only**

V1/V2 auxiliary power supplied to the VME64x backplanes shall remain within the limits of 38V to 75V, including regulation variation, noise and ripple frequencies to 20 MHz.

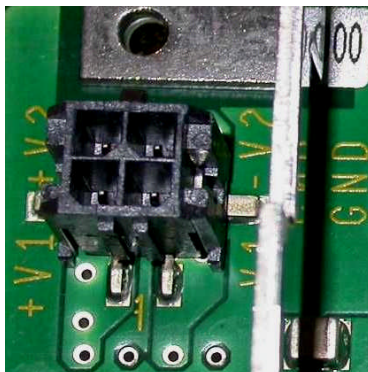
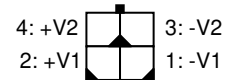

If the +V1 and +V2 voltage rails are tied to ground and the +12V power is used, the nominal voltage between the +12V and the -V1 and -V2 power rails is 60 volts. With voltage tolerances, the 60 volt maximum is exceeded. Additional protection might be needed to comply with local and national regulatory agencies.

Layout for 6U Monolithic VME Backplanes (rear view)

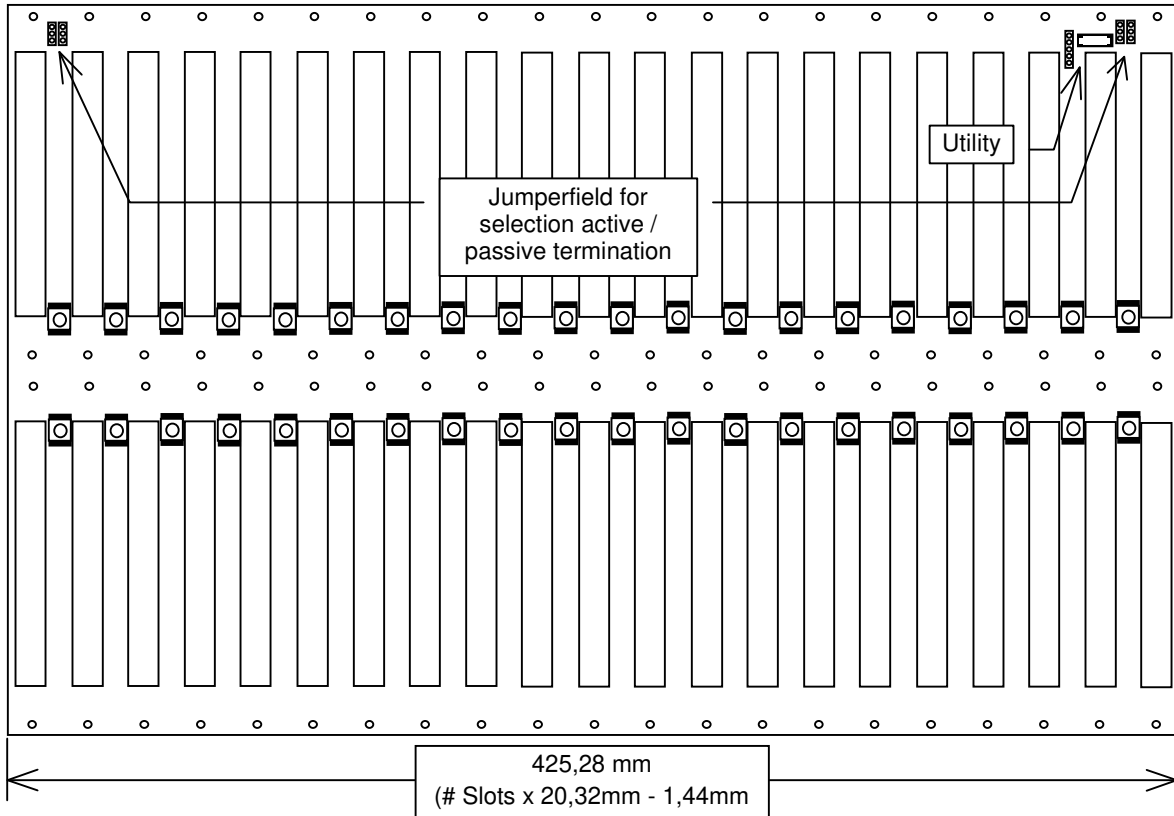

Power Entry Table J1 Backplanes

Powerbug between Slots	Slot x (Faston)	Slot 21-20	Slot 20-19	Slot 19-18	Slot 18-17	Slot 17-16	Slot 16-15	Slot 15-14	Slot 14-13	Slot 13-12	Slot 12-11	Slot 11-10	Slot 10-9	Slot 9-8	Slot 8-7	Slot 7-6	Slot 6-5	Slot 5-4	Slot 4-3	Slot 3-2	Slot 2-1	Slot 1 (Faston)
3 Slot	5V <sub>Stdbby</sub>																			+5V	GND	+12V
4 Slot	5V <sub>Stdbby</sub>																		+/-12	+5V	GND	
5 Slot	5V <sub>Stdbby</sub>																	+/-12	GND	+5V	GND	
6 Slot	5V <sub>Stdbby</sub>																+/-12	+5V	GND	+5V	GND	
7 Slot	5V <sub>Stdbby</sub>														+5V	GND	-12V	+12V	+5V	GND		
8 Slot	5V <sub>Stdbby</sub>													+12V	+5V	GND	-12V	+12V	+5V	GND		
9 Slot	5V <sub>Stdbby</sub>												-12V	+12V	+5V	GND	-12V	+12V	+5V	GND		
10 Slot	5V <sub>Stdbby</sub>												-12V	+12V	GND	+5V	GND	-12V	+12V	+5V	GND	
11 Slot	5V <sub>Stdbby</sub>																					
12 Slot	5V <sub>Stdbby</sub>																					
13 Slot	5V <sub>Stdbby</sub>																					
14 Slot	5V <sub>Stdbby</sub>																					
15 Slot	5V <sub>Stdbby</sub>																					
16 Slot	5V <sub>Stdbby</sub>																					
17 Slot	5V <sub>Stdbby</sub>																					
18 Slot	5V <sub>Stdbby</sub>																					
19 Slot	5V <sub>Stdbby</sub>																					
20 Slot	5V <sub>Stdbby</sub>																					
21 Slot	5V <sub>Stdbby</sub>																					

NOTE: Not all powerbug positions might be assembled.

**Power Entry Table J2 Backplanes**

Powerbug between Slots	Slot x (Faston)	Slot 21-20	Slot 20-19	Slot 19-18	Slot 18-17	Slot 17-16	Slot 16-15	Slot 15-14	Slot 14-13	Slot 13-12	Slot 12-11	Slot 11-10	Slot 10-9	Slot 9-8	Slot 8-7	Slot 7-6	Slot 6-5	Slot 5-4	Slot 4-3	Slot 3-2	Slot 2-1	Slot 1 (Faston)
3 Slot	5V <sub>Stby</sub>																			+5V	GND	
4 Slot	5V <sub>Stby</sub>																		GND	+5V	GND	
5 Slot	5V <sub>Stby</sub>																+5V	GND	+5V	GND		
6 Slot	5V <sub>Stby</sub>															GND	+5V	GND	+5V	GND		
7 Slot	5V <sub>Stby</sub>														+5V	GND	+5V	GND	+5V	GND		
8 Slot	5V <sub>Stby</sub>														GND	+5V	GND	+5V	GND	+5V	GND	
9 Slot	5V <sub>Stby</sub>												+5V	GND	+5V	GND	+5V	GND	+5V	GND	+5V	GND
10 Slot	5V <sub>Stby</sub>												GND	+5V	GND	+5V	GND	+5V	GND	+5V	GND	
11 Slot	5V <sub>Stby</sub>										+5V	GND	+5V	GND	+5V	GND	+5V	GND	+5V	GND	+5V	GND
12 Slot	5V <sub>Stby</sub>										GND	+5V	GND	+5V	GND	+5V	GND	+5V	GND	+5V	GND	
13 Slot	5V <sub>Stby</sub>									+5V	GND	+5V	GND	+5V	GND	+5V	GND	+5V	GND	+5V	GND	
14 Slot	5V <sub>Stby</sub>								GND	+5V	GND	+5V	GND	+5V	GND	+5V	GND	+5V	GND	+5V	GND	
15 Slot	5V <sub>Stby</sub>							+5V	GND	+5V	GND	+5V	GND	+5V	GND	+5V	GND	+5V	GND	+5V	GND	
16 Slot	5V <sub>Stby</sub>						GND	+5V	GND	+5V	GND	+5V	GND	+5V	GND	+5V	GND	+5V	GND	+5V	GND	
17 Slot	5V <sub>Stby</sub>					+5V	GND	+5V	GND	+5V	GND	+5V	GND	+5V	GND	+5V	GND	+5V	GND	+5V	GND	
18 Slot	5V <sub>Stby</sub>				GND	+5V	GND	+5V	GND	+5V	GND	+5V	GND	+5V	GND	+5V	GND	+5V	GND	+5V	GND	
19 Slot	5V <sub>Stby</sub>			+5V	GND	+5V	GND	+5V	GND	+5V	GND	+5V	GND	+5V	GND	+5V	GND	+5V	GND	+5V	GND	
20 Slot	5V <sub>Stby</sub>		GND	+5V	GND	+5V	GND	+5V	GND	+5V	GND	+5V	GND	+5V	GND	+5V	GND	+5V	GND	+5V	GND	
21 Slot	5V <sub>Stby</sub>	+5V	GND	+5V	GND	+5V	GND	+5V	GND	+5V	GND	+5V	GND	+5V	GND	+5V	GND	+5V	GND	+5V	GND	

NOTE: Not all powerbug positions might be assembled.

**Power Entry Table Monolithic Backplanes**

Powerbug between Si.	Slot x (Fast.)	Slot 21-20	Slot 20-19	Slot 19-18	Slot 18-17	Slot 17-16	Slot 16-15	Slot 15-14	Slot 14-13	Slot 13-12	Slot 12-11	Slot 11-10	Slot 10-9	Slot 9-8	Slot 8-7	Slot 7-6	Slot 6-5	Slot 5-4	Slot 4-3	Slot 3-2	Slot 2-1	Slot 1 (Fast.)		
3 Si J1	5V <sub>Stby</sub>																			+5V	GND	+12V		
3 Si J2	GND																			+5V	GND	-12V		
4 Si J1	5V <sub>Stby</sub>																		+/-12	+5V	GND			
4 Si J2																			GND	+5V	GND			
5 Si J1	5V <sub>Stby</sub>																	+/-12	GND	+5V	GND			
5 Si J2																		+5V	GND	+5V	GND			
6 Si J1	5V <sub>Stby</sub>																	+/-12	+5V	GND	+5V	GND		
6 Si J2																		GND	+5V	GND	+5V	GND		
7 Si J1	5V <sub>Stby</sub>															-12V	+12V	+5V	GND	+5V	GND			
7 Si J2																+5V	GND	+5V	GND	+5V	GND			
8 Si J1	5V <sub>Stby</sub>															-12V	+12V	GND	+5V	GND	+5V	GND		
8 Si J2																GND	+5V	GND	+5V	GND	+5V	GND		
9 Si J1	5V <sub>Stby</sub>													-12V	+12V	+5V	GND	+5V	GND	-12V	+12V			
9 Si J2														+5V	GND	+5V	GND	+5V	GND	+5V	GND			
10 Si J1	5V <sub>Stby</sub>												-12V	+12V	GND	+5V	GND	+5V	GND	-12V	+12V			
10 Si J2													GND	+5V	GND	+5V	GND	+5V	GND	+5V	GND			
11 Si J1	5V <sub>Stby</sub>																			GND	-12V	+12V		
11 Si J2																				+5V	GND			
12 Si J1	5V <sub>Stby</sub>											-12V	+12V	GND	+5V	GND	+5V	GND	+5V	GND	-12V	+12V		
12 Si J2												GND	+5V	GND	+5V	GND	+5V	GND	+5V	GND	+5V	GND		
13 Si J1	5V <sub>Stby</sub>																				GND	-12V	+12V	
13 Si J2																					+5V	GND		
14 Si J1	5V <sub>Stby</sub>																				GND	+5V	GND	
14 Si J2																					GND	+5V	GND	
15 Si J1	5V <sub>Stby</sub>																					GND	-12V	+12V
15 Si J2																						+5V	GND	
16 Si J1	5V <sub>Stby</sub>																					GND	+5V	GND
16 Si J2																						GND	+5V	GND
17 Si J1	5V <sub>Stby</sub>																					GND	-12V	+12V
17 Si J2																						+5V	GND	
18 Si J1	5V <sub>Stby</sub>																					GND	+5V	GND
18 Si J2																						GND	+5V	GND
19 Si J1	5V <sub>Stby</sub>																					GND	-12V	+12V
19 Si J2																						+5V	GND	
20 Si J1	5V <sub>Stby</sub>																					GND	+5V	GND
20 Si J2																						GND	+5V	GND
21 Si J1	5V <sub>Stby</sub>																					GND	-12V	+12V
21 Si J2																						GND	+5V	GND

NOTE: Not all powerbug positions might be assembled.

Layout for 6U Monolithic VME64x Backplanes (rear view)

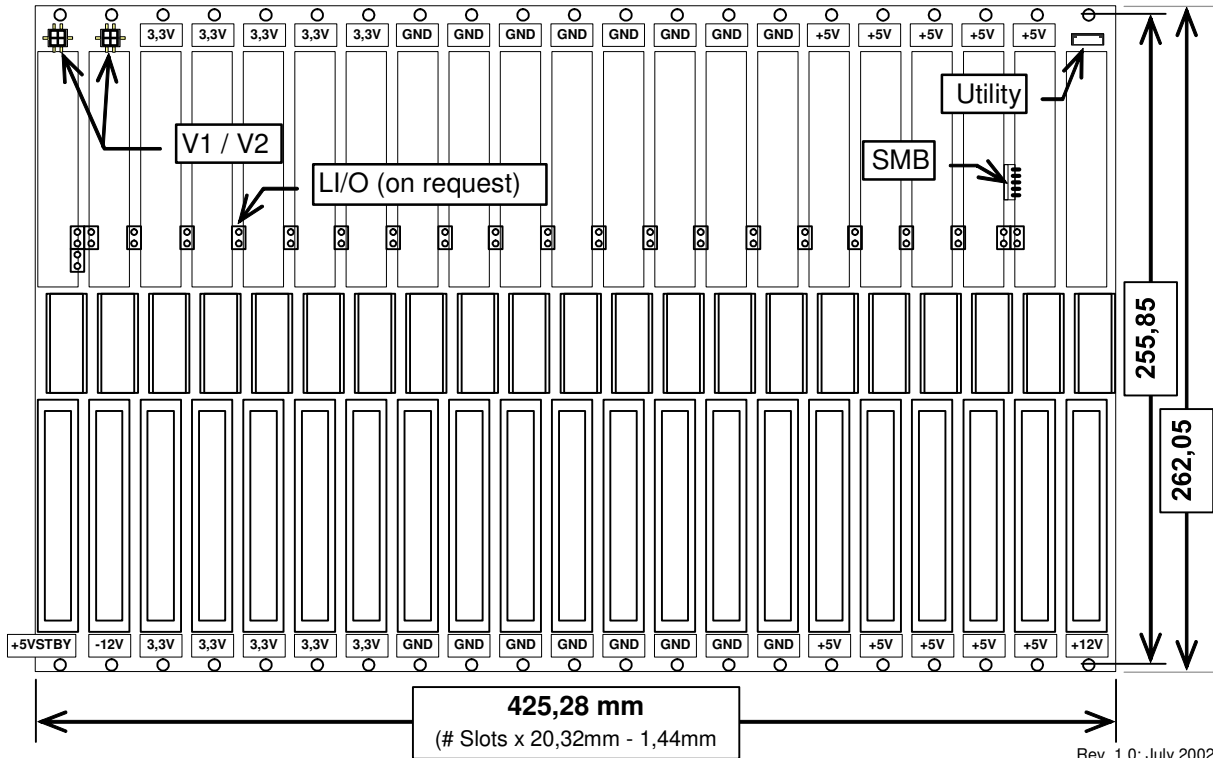

Layout for 7U Monolithic VME64x Backplanes (rear view)

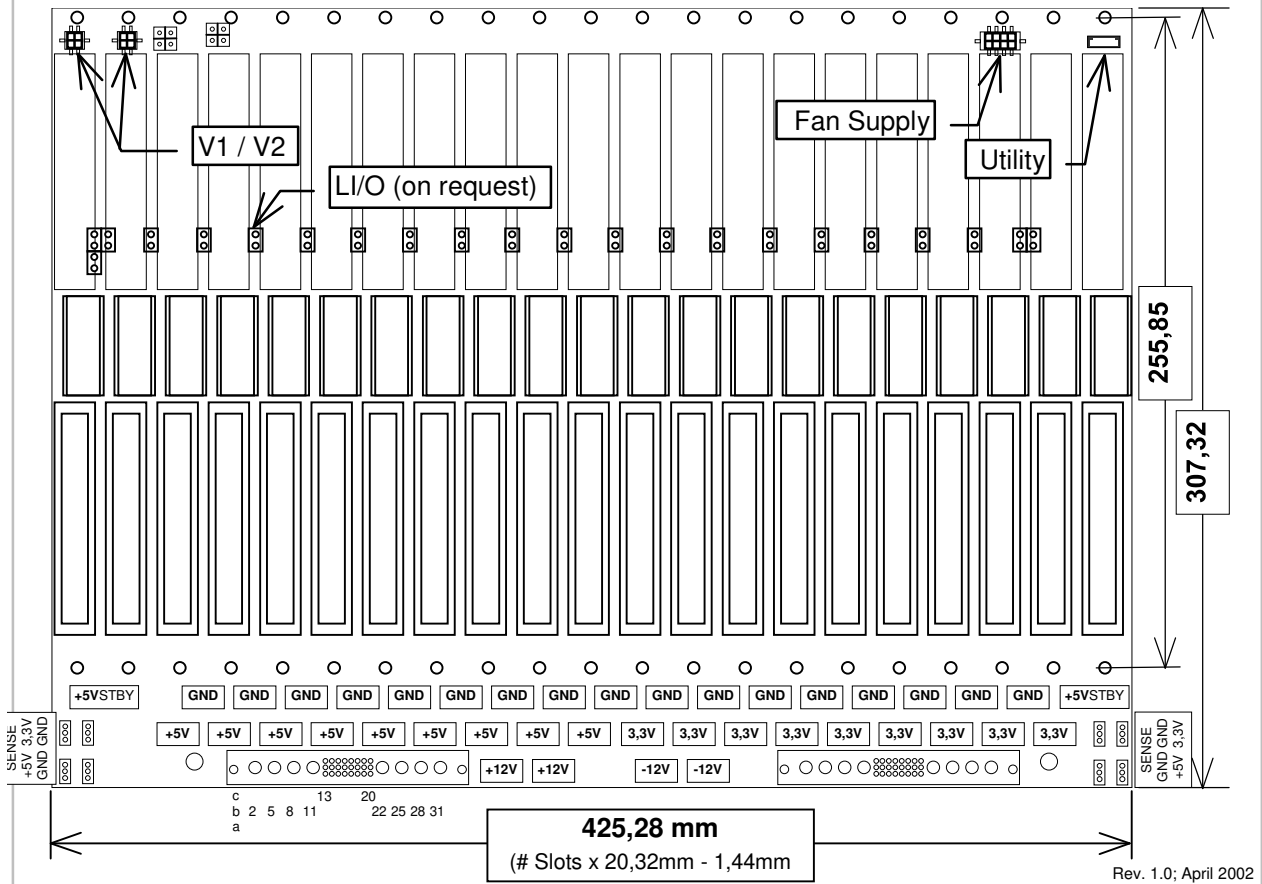

**Accessories**

Article Number	Description
<a href="#">23204-113</a>	Cable IPMB, 750mm length (VME64x Backplanes)
<a href="#">23204-115</a>	Cable Utility-Sense, 12-Way, 350mm length
<a href="#">23204-116</a>	Cable Utility-Sense, 12-Way, 600mm length
<a href="#">20800-304</a>	Cable Utility, 5-Way, 450mm length (VME Backplanes)
<a href="#">60800-330</a>	Jumper Daisy Chain, 10 pieces (VME Backplanes)
<a href="#">69001-995</a>	Locking lever, grey, long, for R96 mating connector (VME Backplanes)
<a href="#">69001-106</a>	Locking lever, black, short, for C96 mating connector (VME Backplanes)

**Mechanical and Climatic Parameters**

	VME Backplanes	VME64x Backplanes
<b>Operating Temperature</b>	-25°C - +85°C (active termination) -40°C - +85°C (passive termination) -40°C - +105°C (on request)	
<b>Storage Temperature</b>	-40°C - +105°C -55°C - +105°C (on request)	
<b>Humidity</b>	95%, non condensing Conformal Coating (on request)	
<b>Climatic Test Group</b> (IEC68/1)	25/085/21	
<b>Flammability</b> (PCB, Connectors)	UL 94 V-0	
<b>Connectors</b> (VME J1, J2)  Performance level per IEC 60603-2 Mechanical Durability (Mating Cycles) Total Insertion and Extraction Force	DIN 41612  Level 2 > 400 cycles < 100 N  DIN 41612 Level 1 (on request)	IEC 61076-4-113 160 way extended DIN  Level 2 > 400 cycles < 160 N  IEC 61076-4-113 Level 1 (on request)
<b>Connectors</b> (VME P0)  Performance level per IEC 60603-2 Mechanical Durability (Mating Cycles) Total Insertion and Extraction Force		IEC 61076-4-101 HM Modul B19, AB compatible with AB Shroud  Level 2 > 250 cycles < 0,7 N / Pin
<b>Vibration</b> acc. DIN 41640 Part 15	10 Hz - 500 Hz, 5 g rms	
<b>Shock</b> (10 pulses each direction x, y, z)	50 g, 6 ms	
<b>Low Pressure / Altitude</b> (max voltage between two pins <=12V)	250 mbar / 20.000 m	
<b>Dimensions</b> (mm)		
Width	20,32 mm x Slots - 1,4 mm	20,32mm x Slots - 1,5 mm
Height (3U / 6U)	128,70 / 262,05 mm	262,05 mm
Thickness	3,2 mm +/- 0,3 mm	4,7 mm +/- 0,5 mm



**Electrical Parameters**

	<b>VME Backplanes</b>	<b>VME64x / VXS Backplanes</b>
<b>Specifications</b>	ANSI/VITA 1-1994 VME64 Specification ANSI/VITA 1.7 - 2003 Increased Current Level for 96 Pin & 160 Pin DIN/IEC Connector Standard	ANSI/VITA 1-1994 VME64 Specification ANSI/VITA 1.1-1997 VME64x Specification ANSI/VITA 1.5-2003 2eSST Transfer Protocol ANSI/VITA 1.7 - 2003 Increased Current Level for 96 Pin & 160 Pin DIN/IEC Connector Standard ANSI/VITA 3-1995 VME64x Live Insertion System Requirements ANSI/VITA 38 – 2003 SMB Specification, Draft VITA 41 – 2006 VXS VMEbus Switched Serial Standard
<b>Service Life</b> MTBF, acc. to MIL HDBK 217F, 25°C, ground, benign; 21-Slot Monolithic	more than 235.000 h	
<b>Characteristic Impedance</b>	55 Ω ± 10 % (Single ended) / 100 Ω ± 10 % (differential impedance)	
<b>Ohmic Resistance (parallel bus)</b>	< 60 mΩ / Slot	
<b>Hot Swap</b>	not supported	Supported
<b>Termination</b>	active / passive, field changeable 330 / 470 Ohm Networks	passive 330 / 470 Ohm Networks
<b>Power input</b> 4 to 21 Slots 2 Slots	Power bugs for wiring, comprising M4 Screws Fastons	
<b>Max. Current Carrying Capacity</b>	per ANSI/VITA 1.7-2003 3U BP: +5V, 6 A / Slot @ 95°C 6U BP: +5V, 12 A / Slot @ 95°C	per ANSI/VITA 1.7-2003 +5V: 12A / Slot @ 95°C +3,3V: 18 A / Slot @ 95°C +/-12V;+/-V1;+/-V2: 2 A / Slot @ 95°C each VPC: 6 A / Slot @ 95°C
<b>Max. Leakage Current</b> on +5VStby	30 nA	
<b>Max. Voltage Drop</b> on +5V	< 50 mV	
<b>Data Transfer Rate</b> (peak) VMEbus MBLT protocol 2eVME 2eSST	80 Mbyte/s 160 Mbyte/s	80 Mbyte/s 160 Mbyte/s 320 Mbyte/s
<b>Data Transfer Rate</b> (peak) serial links	10 Gbit/s	