



Chipsmall Limited consists of a professional team with an average of over 10 year of expertise in the distribution of electronic components. Based in Hongkong, we have already established firm and mutual-benefit business relationships with customers from,Europe,America and south Asia,supplying obsolete and hard-to-find components to meet their specific needs.

With the principle of “Quality Parts,Customers Priority,Honest Operation,and Considerate Service”,our business mainly focus on the distribution of electronic components. Line cards we deal with include Microchip,ALPS,ROHM,Xilinx,Pulse,ON,Everlight and Freescale. Main products comprise IC,Modules,Potentiometer,IC Socket,Relay,Connector.Our parts cover such applications as commercial,industrial, and automotives areas.

We are looking forward to setting up business relationship with you and hope to provide you with the best service and solution. Let us make a better world for our industry!



Contact us

Tel: +86-755-8981 8866 Fax: +86-755-8427 6832

Email & Skype: info@chipsmall.com Web: www.chipsmall.com

Address: A1208, Overseas Decoration Building, #122 Zhenhua RD., Futian, Shenzhen, China



S5/S7 ADAPTER

VARIOFACE S5/S7 Adapters for Siemens SIMATIC® S7

INTERFACE

Data Sheet
101976_en_05

© PHOENIX CONTACT 2010-06-28



1 Description

For systems that are automated with SIMATIC® S5-115 and 135/155, various Phoenix Contact VARIOFACE S5/S7 adapters can be used to connect the existing SIMATIC® S5 field wiring directly to SIMATIC® S7. This saves both time and money. Costly rewiring of individual modules is not required.

During downtimes, such as weekends, systems can be tested with SIMATIC® S7 and can also be operated during production times with SIMATIC® S5. Once the changeover is complete, SIMATIC® S7 controls the system via VARIOFACE S5/S7 adapters and the old SIMATIC® S5 field wiring.

VARIOFACE S5/S7 adapters ensure safe system operation using modern control systems.

2 Table of Contents

1	Description	1
2	Table of Contents	1
3	Adapters for Converting S5-115 to S7-400	2
3.1	6ES5 420... to 6ES5 465.....	2
4	Adapters for Converting S5-115 to S7-300	3
4.1	6ES5 420... to 6ES5 451.....	3
5	Commissioning adapters for extending the existing S5-115 field wiring.....	4
6	Adapters for Converting S5-135/155 to S7-400	5
6.1	6ES5 420... to 6ES5 432.....	5
6.2	6ES5 436... to 6ES5 453.....	6
6.3	6ES5 454... to 6ES5 460.....	7
6.4	6ES5 465... to 6ES5 470.....	8
7	Adapters for Converting S5-135 to S7-300	9
7.1	6ES5 420... to 6ES5 451.....	9
8	Commissioning adapters for extending the existing S5-135 field wiring	10



Make sure you always use the latest documentation.
It can be downloaded at www.phoenixcontact.net/catalog.

3 Adapters for Converting S5-115 to S7-400

FLKM S115/... adapters provide a direct connection between a SIMATIC® S5 connector wired with individual wires and the SIMATIC® S7-400 base board. The SIMATIC® S5 connector is plugged directly into an S7-400 I/O card with the aid of the FLKM S115/... adapter. A new

SIMATIC® S7-400 is installed in place of the SIMATIC® S5. The existing field wiring remains intact.

Attention: Due to the geometry, it is only possible to use every other slot. The LEDs of the S7-400 module are hidden by the S5-115 adapter.

3.1 6ES5 420... to 6ES5 465...

Ordering Data

Description	Type	Order No.	Pcs./Pck.
Digital IN and OUT 24 V DC from S5-115 to S7-400			
IN 6ES5 420-7LA11 to 6ES7-421-1BL01-0AA0 6ES5 430-7LA11 to 6ES7-421-1BL01-0AA0	FLKM S115/S400/SO155	2307248	1
OUT 6ES5 441-7LA11 to 6ES7 422-1BL00-0AA0 6ES5 451-7LA11 to 6ES7 422-1BL00-0AA0			
Digital OUT 24 V DC from S5-115 to S7-400			
6ES5 454-7LA12 to 6ES7 422 1BH11-0AA0	FLKM S115-454-7LA/S400	2314901	1
Analog IN (current and voltage measurement only) from S5-115 to S7-400			
6ES5 465-7LA13 to 6ES7 431 0HH00-0AB0 6ES5 465-7LA13 to 6ES7 431 7QH00-0AB0	FLKM S115-465-7LA/UI/S400	2314914	1



Technical Data

Maximum permissible operating voltage	24 V AC/DC
Maximum permissible current (per branch)	4 A
Maximum permissible current (separate power supply)	4 A
Test voltage	500 V (50 Hz, 1 min.)
Ambient temperature (operation)	-20°C ... +50°C
Mounting position	Vertical
Standards/specifications	DIN EN 50178/IEC 62103

Connection Schemes

FLKM S115/S400/SO155

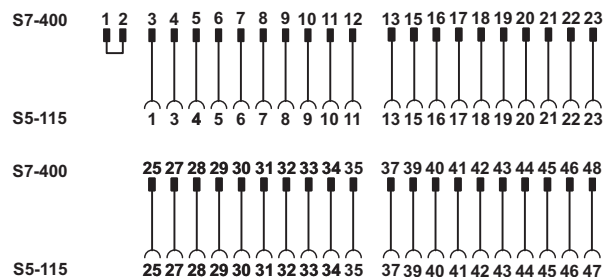

FLKM S115-465-7LA/UI/S400

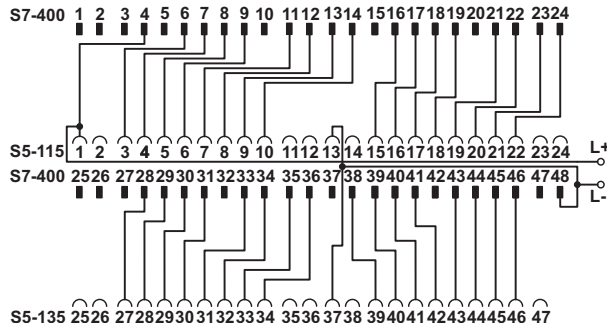

FLKM S115-454-7LA/S400

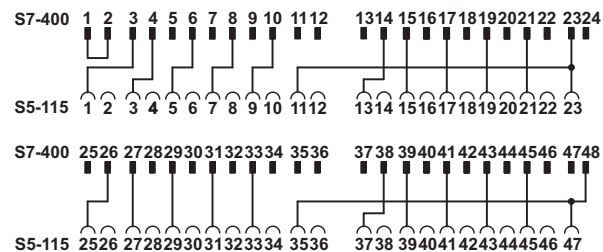

4 Adapters for Converting S5-115 to S7-300

S5/S7 adapters connect S5-115 front adapters wired with individual wires to S7-300 I/O modules. With the aid of the FLKM S115/S7/FLK50/SO13 converter module, the signals of the S5-115 front adapter can be converted to a 50-pos. strip.

An FLK 50/EZ-DR/.../KONFEK 50-pos. system cable and a front adapter for SIMATIC® S7-300 (FLKM 50-PA-S300) connect the signals to the I/O module.

4.1 6ES5 420... to 6ES5 451...

Ordering Data

Description

Digital IN and OUT 24 V DC from S5-115 via converter, system cable, and front adapter to S7-300

IN

6ES5 420-7LA11 to 6ES7 321-1BL00-0AA0

6ES5 430-7LA11 to 6ES7 321-1BL00-0AA0

OUT

6ES5 441-7LA11 to 6ES7 322-1BL00-0AA0

6ES5 451-7LA11 to 6ES7 322-1BL00-0AA0

Type

FLKM S115/S7/FLK50/PLC/SO137 2306294

Order No.

Pcs./Pck.

1



Technical Data

Maximum permissible operating voltage

24 V AC/DC

Maximum permissible current (per branch)

1 A

Maximum permissible current (separate power supply)

2 A

Test voltage

500 V (50 Hz, 1 min.)

Ambient temperature (operation)

-20°C ... +50°C

Mounting position

Any

Standards/specifications

DIN EN 50178/IEC 62103

Connection Scheme

FLKM S115/S7/FLK50/PLC/SO137

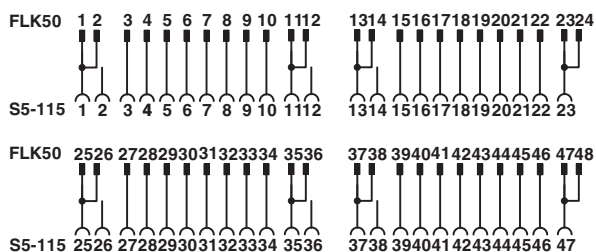

Application Example



5 Commissioning adapters for extending the existing S5-115 field wiring

All signals of the existing S5-115 wiring are extended 3 or 5 meters with the help of the universal commissioning adapters. The open cable end can be connected to various controllers such as S7-400 or S7-300. Thus, the existing field wiring of S5-115 can communicate with the new controller for test purposes.

Since the new control unit is temporarily arranged before the control cabinet, the original status of the system can be restored if required.

If the system functions with the new controller without problems, the S5-115 can now be replaced.

Ordering Data

Description	Type	Order No.	Pcs./Pck.
Connection of all S5-115 connections (1 to 23, 25 to 47) at the open cable end, cable length 3 m	FLKM S115/47X0,75/3,0M/OE	2314985	1
Connection of all S5-115 connections (1 to 23, 25 to 47) at the open cable end, cable length 5 m	FLKM S115/47X0,75/5,0M/OE	2314998	1



Technical Data

Maximum permissible operating voltage	250 V AC/DC
Maximum permissible current (per branch)	6 A
Ambient temperature (operation)	-20 °C ... 50 °C
Ambient temperature (storage/transport)	-20 °C ... 80 °C
Mounting position	Any
Standards/specifications	EN 60664-1

Connection Scheme

FLKM S115/47X0,75/...M/OE



Application Example



6 Adapters for Converting S5-135/155 to S7-400

FLKM S135/... adapters provide a direct connection between a SIMATIC® S5 connector wired with individual wires and the SIMATIC® S7-400 base board. The SIMATIC® S5 connector is plugged directly into an S7-400 I/O card with the aid of the FLKM S135/... adapter. A new

SIMATIC® S7-400 is installed in place of the SIMATIC® S5. The existing field wiring remains intact.

Attention: The LEDs of the S7-400 module are hidden.

6.1 6ES5 420... to 6ES5 432...

Ordering Data

Description	Type	Order No.	Pcs./Pck.
Digital IN 24 V/60 V from S5-135/155 to S7-400			
6ES5 420-4UA14 to 6ES7 421-1BL01-0AA0	① FLKM S135/S400/S0120	2301723	1
6ES5 430-4UA14 to 6ES7 421-1BL01-0AA0	② FLKM S135/S400/SO121	2301736	1
6ES5 431-4UA12 to 6ES7 421-7DH00-0AB0	③ FLKM S135-431-4UA/S400	2314846	1
6ES5 432-4UA12 to 6ES7 421-1BL01-0AA0	④ FLKM S135/S400/SO122	2301749	1



Technical Data

Maximum permissible operating voltage

Maximum permissible current (per branch)

Maximum permissible current (separate power supply)

Test voltage

Ambient temperature (operation)

Mounting position

Standards/specifications

①	②	③	④
24 V AC/DC	60 V DC	24 V DC	24 V AC/DC
4 A	2 A	4 A	4 A
4 A	2 A	4 A	4 A
500 V (50 Hz, 1 min.)	1.25 kV (50 Hz, 1 min.)	1.25 kV (50 Hz, 1 min.)	1.25 kV (50 Hz, 1 min.)
-20°C ... +50°C			
Any			
DIN EN 50178/IEC 62103			

Connection Schemes

FLKM S135/S400/S0120

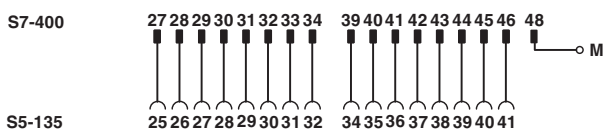
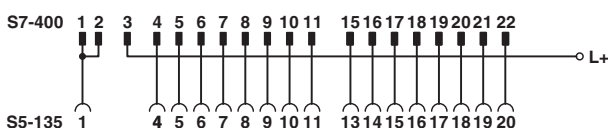

FLKM S135/S400/SO121

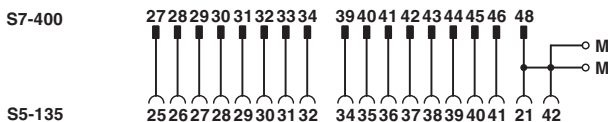
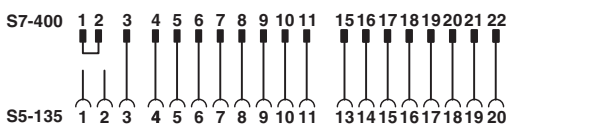

FLKM S135-431-4UA/S400

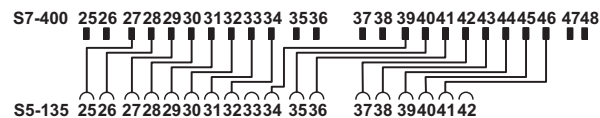
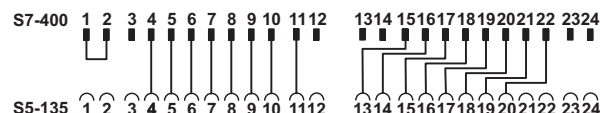

FLKM S135/S400/SO122

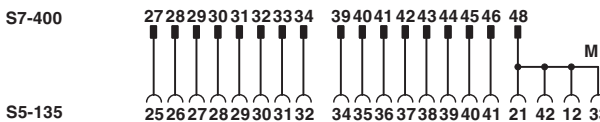
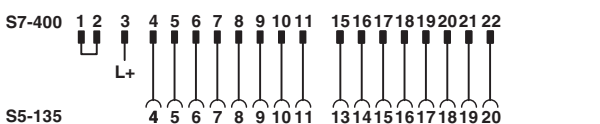

6.2 6ES5 436... to 6ES5 453...

Ordering Data

Description	Type	Order No.	Pcs./Pck.
Digital IN 120/230 V UC from S5-135/155 to S7-400 6ES5 436-4UA12 to 6ES7 421-1FH20-0AA0	① FLKM S135/S400/SO123	2301752	1
Digital OUT 24 V from S5-135/155 to S7-400 6ES5 441-4UA12 to 6ES7 422-1BL00-0AA0	② FLKM S135/S400/SO125	2301778	1
6ES5 451-4UA14 to 6ES7 422-1BL00-0AA0	③ FLKM S135/S400/SO126	2301781	1
Digital OUT 24 V DC/2 A from S5-135/155 to S7-400 6ES5 453-4UA12 to 6ES7 422-1HH00-0AA0	④ FLKM S135/S400/SO127	2301794	1



Technical Data	①	②	③	④
Maximum permissible operating voltage	230 V AC/DC	24 V AC/DC	24 V DC	24 V DC
Maximum permissible current (per branch)	4 A			
Maximum permissible current (separate power supply)	4 A			
Test voltage	1.5 kV (50 Hz, 1 min.)	500 V (50 Hz, 1 min.)	1.25 kV (50 Hz, 1 min.)	500 V (50 Hz, 1 min.)
Ambient temperature (operation)	-20°C ... +50°C			
Mounting position	Any			
Standards/specifications	DIN EN 50178/IEC 62103			

Connection Schemes

FLKM S135/S400/SO123

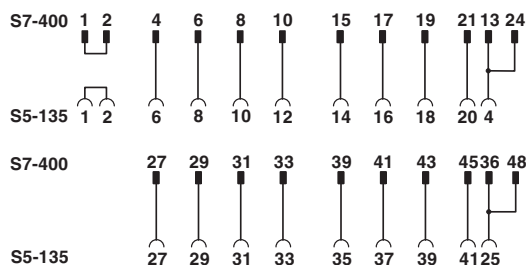

FLKM S135/S400/SO126

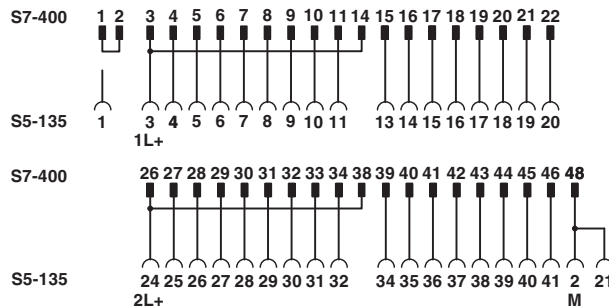

FLKM S135/S400/SO125

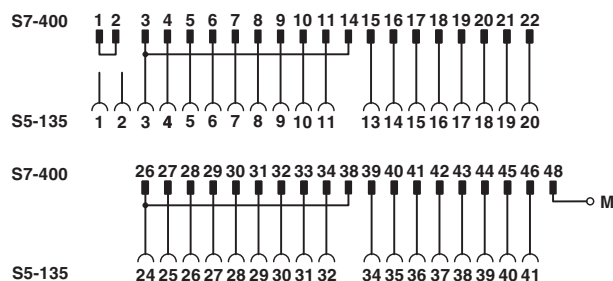

FLKM S135/S400/SO127

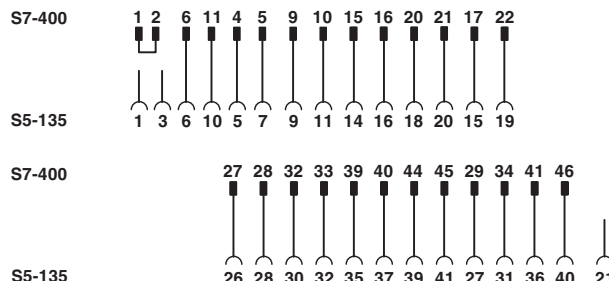

6.3 6ES5 454... to 6ES5 460...

Ordering Data

Description	Type	Order No.	Pcs./Pck.
Digital OUT 24 V DC/2 A from S5-135/155 to S7-400 6ES5 454-4UA14 to 6ES7 422-1BH11-0AA0	① FLKM S135-454-4UA/S400	2314859	1
Digital OUT 230 V UC/2 A from S5-135/155 to S7-400 6ES5 456-4UA12 to 6ES7 422-1FH00-0AA0	② FLKM S135/S400/SO124	2301765	1
Analog IN (current measurement only) from S5-135/155 to S7-400 6ES5 460-4UA13 to 6ES7 431-1KF00-0AB0	③ FLKM S135-460-4UA/I/S400	2314613	1
Analog IN (voltage measurement only) from S5-135/155 to S7-400 6ES5 460-4UA13 to 6ES7 431-1KF00-0AB0	④ FLKM S135-460-4UA/U/S400	2314862	1



Technical Data

	①	②	③	④
Maximum permissible operating voltage	24 V DC	230 V AC	24 V DC	24 V DC
Maximum permissible current (per branch)	4 A			
Maximum permissible current (separate power supply)	4 A			
Test voltage	1.25 kV (50 Hz, 1 min.)	1.5 kV (50 Hz, 1 min.)	500 V (50 Hz, 1 min.)	500 V (50 Hz, 1 min.)
Ambient temperature (operation)	-20°C ... +50°C			
Mounting position	Vertical			
Standards/specifications	DIN EN 50178/IEC 62103			

Connection Schemes

FLKM S135-454-4UA/S400

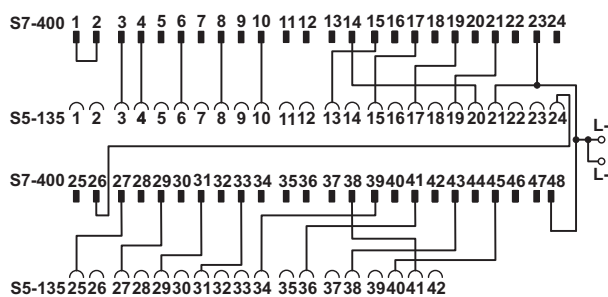

FLKM S135-460-4UA/I/S400

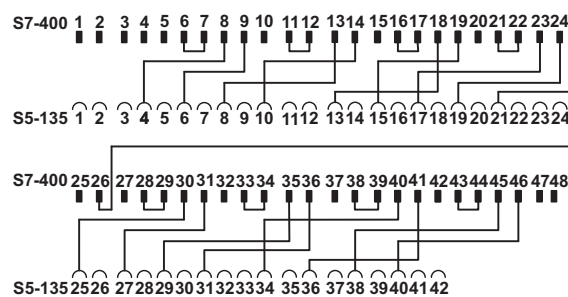

FLKM S135/S400/SO124

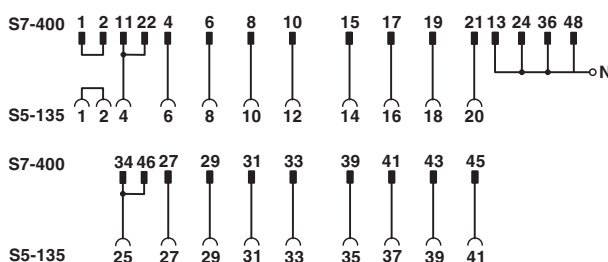

FLKM S135-460-4UA/U/S400

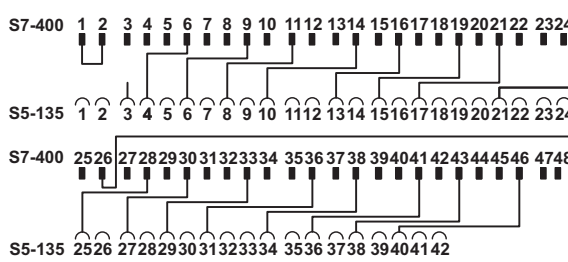

6.4 6ES5 465... to 6ES5 470...

Ordering Data

Description	Type	Order No.	Pcs./Pck.
Analog IN (Pt 100 only) from S5-135/155 to S7-400 6ES5 465-4UA13 to 6ES7 431-7KF10-0AB0	① FLKM S135-465-4UA/T/S400	2314875	1
Analog IN (current and voltage measurement only) from S5-135/155 to S7-400 6ES5 465-4UA13 to 6ES7 431-0HH00-0AB0 6ES5 465-4UA13 to 6ES7 431-7QH00-0AB0	② FLKM S135-465-4UA/UI/S400	2314888	1
Analog OUT (current output only) from S5-135/155 to S7-400 6ES5 470-4UA13 to 6ES7 432-1HF00-0AB0 6ES5 470-4UC13 to 6ES7 432-1HF00-0AB0	③ FLKM S135-470-4UC/I/S400	2314626	1
Analog OUT (voltage output only) from S5-135/155 to S7-400 6ES5 470-4UA13 to 6ES7 432-1HF00-0AB0 6ES5 470-4UB13 to 6ES7 432-1HF00-0AB0 6ES5 470-4UC13 to 6ES7 432-1HF00-0AB0	④ FLKM S135-470-4UC/U/S400	2314891	1



Technical Data

Maximum permissible operating voltage	24 V DC			
Maximum permissible current (per branch)	2 A	4 A	4 A	4 A
Maximum permissible current (separate power supply)	2 A	4 A	4 A	4 A
Test voltage	500 V (50 Hz, 1 min.)			
Ambient temperature (operation)	-20°C ... +50°C			
Mounting position	Any			
Standards/specifications	DIN EN 50178/IEC 62103			

	①	②	③	④
Maximum permissible operating voltage	24 V DC			
Maximum permissible current (per branch)	2 A	4 A	4 A	4 A
Maximum permissible current (separate power supply)	2 A	4 A	4 A	4 A
Test voltage	500 V (50 Hz, 1 min.)			
Ambient temperature (operation)	-20°C ... +50°C			
Mounting position	Any			
Standards/specifications	DIN EN 50178/IEC 62103			

Connection Schemes

FLKM S135-465-4UA/T/S400

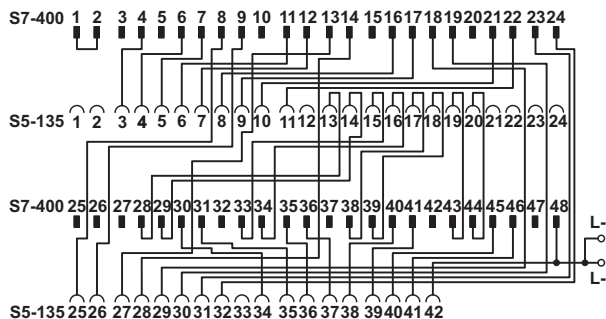

FLKM S135-470-4UC/I/S400

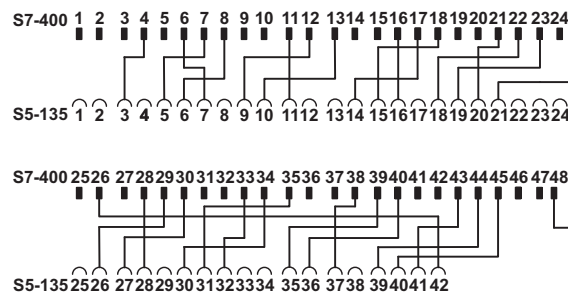

FLKM S135-465-4UA/UI/S400

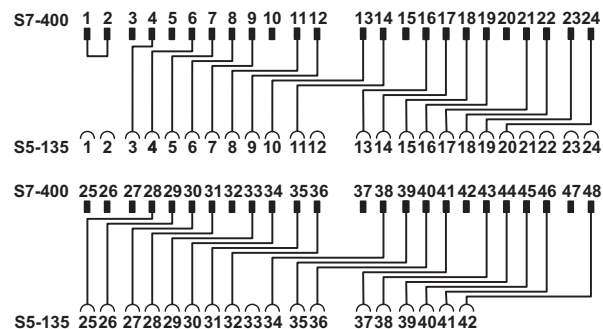

FLKM S135-470-4UC/U/S400

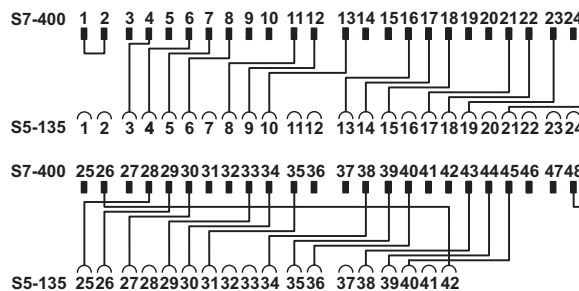

7 Adapters for Converting S5-135 to S7-300

S5/S7 adapters connect S5-135 front adapters wired with individual wires to S7-300 I/O modules. With the aid of the FLKM S135/S7/FLK50 converter module, the signals of the S5-135 front adapter can be converted to a 50-pos. strip. An

FLK 50/EZ-DR/.../KONFEK 50-pos. system cable and a front adapter for SIMATIC® S7-300 (FLKM 50-PA-S300) connect the signals to the I/O module.

7.1 6ES5 420... to 6ES5 451...

Ordering Data

Description	Type	Order No.	Pcs./Pck.
Digital IN and OUT 24 V DC from S5-135 to S7-300			
IN 6ES5 420-4UA14 to 6ES7 321-1BL00-0AA0 6ES5 430-4UA14 to 6ES7 321-1BL00-0AA0	FLKM S135/S7/FLK50/PLC	2314736	1
OUT 6ES5 441-4UA14 to 6ES7 322-1BL00-0AA0 6ES5 451-4UA14 to 6ES7 322-1BL00-0AA0			



Technical Data

Maximum permissible operating voltage	30 V AC/DC
Maximum permissible current (per branch)	1 A
Maximum permissible current (separate power supply)	2 A
Test voltage	500 V (50 Hz, 1 min.)
Ambient temperature (operation)	-20°C ... +50°C
Mounting position	Any
Standards/specifications	DIN EN 50178/IEC 62103

Connection Schemes

FLKM S135/S7/FLK50/PLC

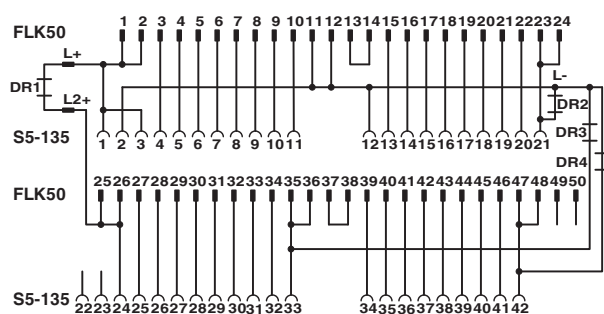

Application Example



8 Commissioning adapters for extending the existing S5-135 field wiring

All signals of the existing S5-135 wiring are extended 3 or 5 meters with the help of the universal commissioning adapters. The open cable end can be connected to various controllers such as S7-400 or S7-300. Thus, the existing field wiring of S5-135 can communicate with the new controller for test purposes.

Ordering Data

Description	Type	Order No.	Pcs./Pck.
Connection of all S5-135 connections (1 to 42) at the open cable end, cable length 3 m	FLKM S135/42X0,75/3,0M/OE	2315007	1
Connection of all S5-135 connections (1 to 42) at the open cable end, cable length 5 m	FLKM S135/42X0,75/5,0M/OE	2318017	1



Technical Data

Maximum permissible operating voltage	250 V AC/DC
Maximum permissible current (per branch)	6 A
Ambient temperature (operation)	-20 °C ... 50 °C
Ambient temperature (storage/transport)	-20 °C ... 80 °C
Mounting position	Any
Standards/specifications	EN 60664-1

Connection Schemes

FLKM S135/42X0,75 /...M/OE

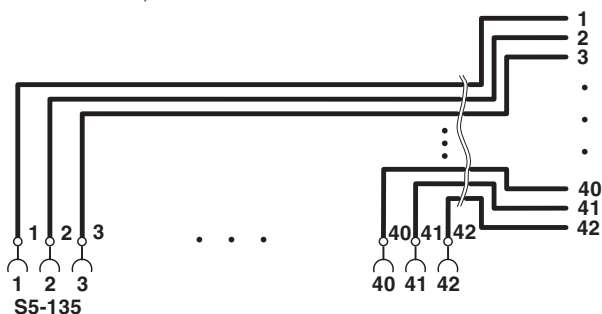

Application Example

