



Chipsmall Limited consists of a professional team with an average of over 10 year of expertise in the distribution of electronic components. Based in Hongkong, we have already established firm and mutual-benefit business relationships with customers from,Europe,America and south Asia,supplying obsolete and hard-to-find components to meet their specific needs.

With the principle of “Quality Parts,Customers Priority,Honest Operation,and Considerate Service”,our business mainly focus on the distribution of electronic components. Line cards we deal with include Microchip,ALPS,ROHM,Xilinx,Pulse,ON,Everlight and Freescale. Main products comprise IC,Modules,Potentiometer,IC Socket,Relay,Connector.Our parts cover such applications as commercial,industrial, and automotives areas.

We are looking forward to setting up business relationship with you and hope to provide you with the best service and solution. Let us make a better world for our industry!



Contact us

Tel: +86-755-8981 8866 Fax: +86-755-8427 6832

Email & Skype: info@chipsmall.com Web: www.chipsmall.com

Address: A1208, Overseas Decoration Building, #122 Zhenhua RD., Futian, Shenzhen, China



Connection Technology for Field Devices

2

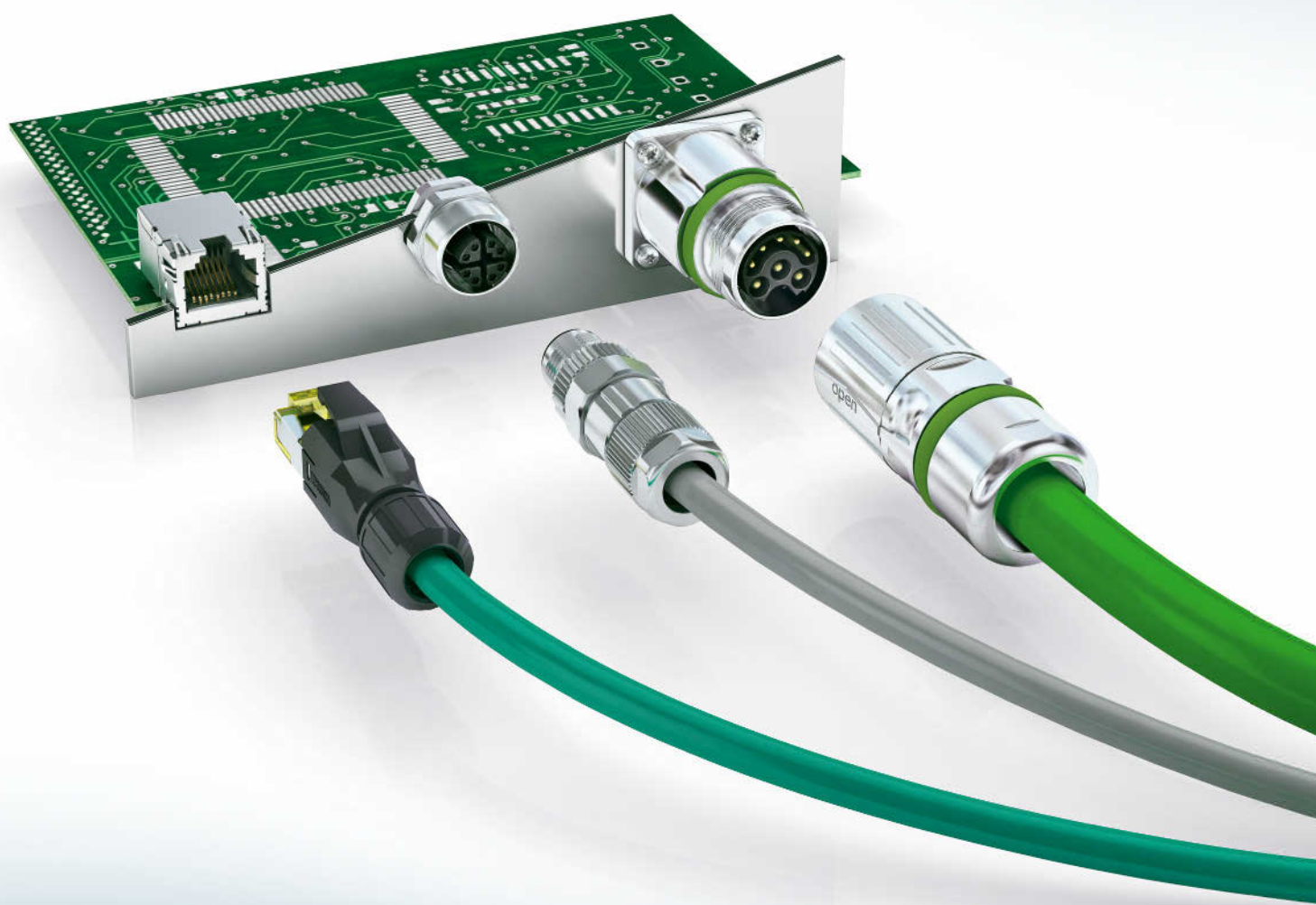



PCB connection technology and electronics housing

- PCB terminal blocks and plug-in connectors
- Electronics housing



Connection technology for field devices



Modular terminal blocks

- Modular terminal blocks



Sensor/actuator cabling and industrial plug-in connectors

- Sensor/actuator cabling
- Cables and connectors
- Plug-in connectors



Marking systems, tools, and mounting material

- Marking and labeling
- Tools
- Installation and mounting material



Surge protection and power supply units

- Lightning monitoring system
- Surge protection and interference filters
- Power supply units and UPS
- Protective devices



Interface technology and switching devices







- Electronic switching devices and motor control
- Measurement and control technology • Monitoring
- Relay modules • System cabling for controllers



Control technology, I/O systems and automation infrastructure

- Ethernet networks • Functional safety • HMIs and industrial PCs • I/O systems
- Industrial lighting and signaling • Industrial communication technology
- Fieldbus components and systems • Wireless data communication
- Process infrastructure • Software • Controllers

Table of contents

Connection technology for field devices from Phoenix Contact Universal for signal/data and power transmission			2
Individual connection solutions Implement your individual connection for devices and field cabling with the expertise of Phoenix Contact			4
Overview - connection technology for field devices The illustrated table of contents will help you find the right product more quickly.	PLUSCON		14
Rectangular plug-in connectors Device plug-in connectors with modular contact system for signals, power, and fiber optics.	PLUSCON device		19
Data plug-in connectors Plug-in connectors, flush-type plug-in connectors, and cables for fieldbuses and networks: D-SUB, RJ45, M8, M12, 7/8", SCRJ, and USB.	PLUSCON data		61
M5 to M12 circular plug-in connectors Flush-type plug-in connectors and plug-in connectors for assembly from M5 to M12, for signals, data, and power.	PLUSCON circular		223
M17 to M58 circular plug-in connectors Flush-type plug-in connectors and plug-in connectors for assembly from M17 to M58, for signals, data, and power.	PLUSCON circular		303
Photovoltaic plug-in connectors AC and DC connection systems for photovoltaic modules, inverters, and micro inverters.	PLUSCON solar		417
Charging plug-in connectors Plug-in charging systems for electromobility up to 400 A and plug-in connectors for power electronics up to 150 A.	PLUSCON power		431
Technical information General information on the degree of protection, properties of plastics, approvals, insulation coordination, etc.			442
Index			454

Connection technology for field devices from Phoenix Contact

COMBICON control

Connection technology for measurement and control technology and I/O modules: PCB terminal blocks and plug-in connectors with 2.54 to 7.62 mm pitch, screw, spring-cage, and insulation displacement connection, wave soldering.
See Catalog 1



COMBICON high density & data

Plug-in connectors in miniature format - fast insulation displacement, spring, and pierce connection technology, T-branches for easy bus connections.

See Catalog 1



COMBICON power

Connection technology for power electronics: PCB terminal blocks and plug-in connectors for currents up to 125 A, screw and spring-cage connection, panel feed-throughs.

See Catalog 1



COMBICON compact

Device connections for building technology and LED applications: PCB terminal blocks and plug-in connectors with 2.5 to 7.5 mm pitch, screw and spring-cage connection as well as pin strips.

See Catalog 1

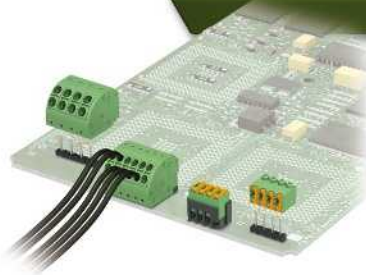

Housing

Plastic and aluminum electronics housing: component housing and panel mounting bases for industrial electronics, component housing for building installation, innovative bus connections between housing.

See Catalog 1

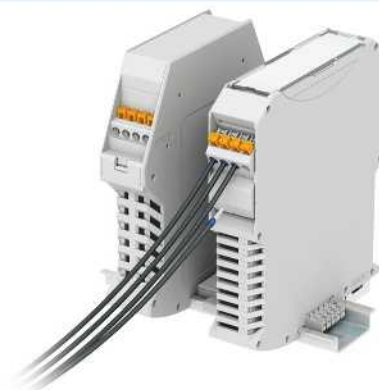

TA

POWER



PLUSCON data

Plug-in connectors, panel feed-throughs, and cables for fieldbuses and networks.

See 61



PLUSCON circular

Flush-type plug-in connectors, plug-in connectors for assembly, and cables from M5 to M58 for signals, data, and power.

For M5 to M12, see 223
For M17 to M58, see 303



PLUSCON power

Plug-in charging systems for electromobility up to 400 A and plug-in connectors for power electronics up to 150 A.

See 431

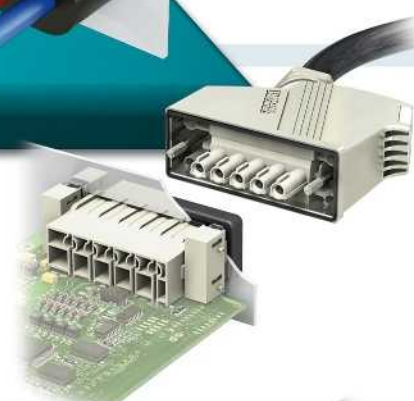

PLUSCON device

Rectangular plug-in connectors with modular contact system for signals, power, and fiber optics with IP67 protection and available in various sizes.

See 19



PLUSCON solar

AC and DC connection systems for photovoltaic modules, inverters, and micro inverters.

See 417

Connection technology for field devices from Phoenix Contact



Individual connection solutions

Customer-specific adaptation of standard products

Found a product in our catalogs that meets your technical requirements, but you'd prefer a tailored solution? No problem – our Solution Center will be happy to provide you with support in implementing your requirements. Whether it's individual colors, special printing, a specific number of contacts or complete cable assembly – just let us know what you want.

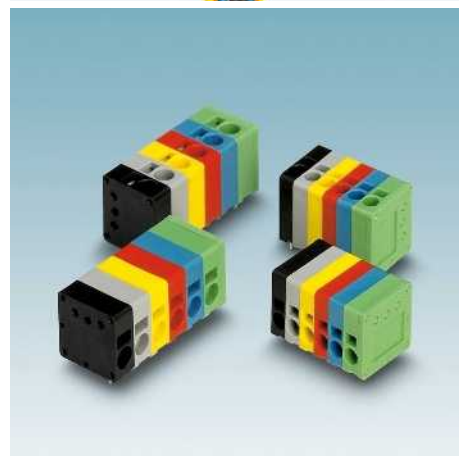

Ideas transformed into innovative products

Phoenix Contact has been producing high-quality products for worldwide use for over 80 years.

Benefit from our extensive development, manufacturing, and process expertise for your individual solution. Together with you, we can transform great ideas into innovative products.

Intelligent solutions in housing and connection technology increasingly require custom concepts.

As a manufacturer, you can develop products with us that meet the requirements of today's markets, such as high quality, individual design, and great customer benefits at a reasonable price.

You will have the entire expertise of the Phoenix Contact Group at your disposal. From our own tool shop and machine building through plastic injection molding and metal production to expertise in electronics production, we offer a depth of manufacturing that enables us to implement even demanding projects and complex products within a short development period.

Our own laboratory carries out testing throughout the process, handles the necessary qualifications and, of course, international approvals.

As a manufacturer, you can focus on your core competencies and benefit from our expertise as specialists in connection and housing technology.

Great products need great ideas and experience. Together with the expertise of Phoenix Contact, you can implement your individual solution - right from the initial idea to cost-effective series production.

Our products and services range from customer-specific PCB connection technology with screw, spring-cage or IDC fast connection, in all conceivable designs and colors...

...through corresponding electronics housing in special designs in the color and size of your choice, together with the appropriate connection technology...

...individual field cabling, with plug-in connectors with shielding for high data transmission rates, splash-proof housing for harsh industrial environments...

...to complete solutions consisting of, for example, splash-proof housing including the appropriate connection technology for signal, data, and power transmission, plus the ideal PCB connection.



Connection technology for field devices from Phoenix Contact

Our service – added value for you

Phoenix Contact doesn't just offer the right products, it also provides a professional service for all aspects of connection technology for field devices and field cabling. Wherever you are in the world, Phoenix Contact's global network means that you can rely on our service. Being at home all over the world and speaking the language of the user is what we understand by customer proximity. Proximity that ensures the best service for our partners. We live up to this with more than 40 customer-oriented subsidiaries and around 30 representatives in other countries.

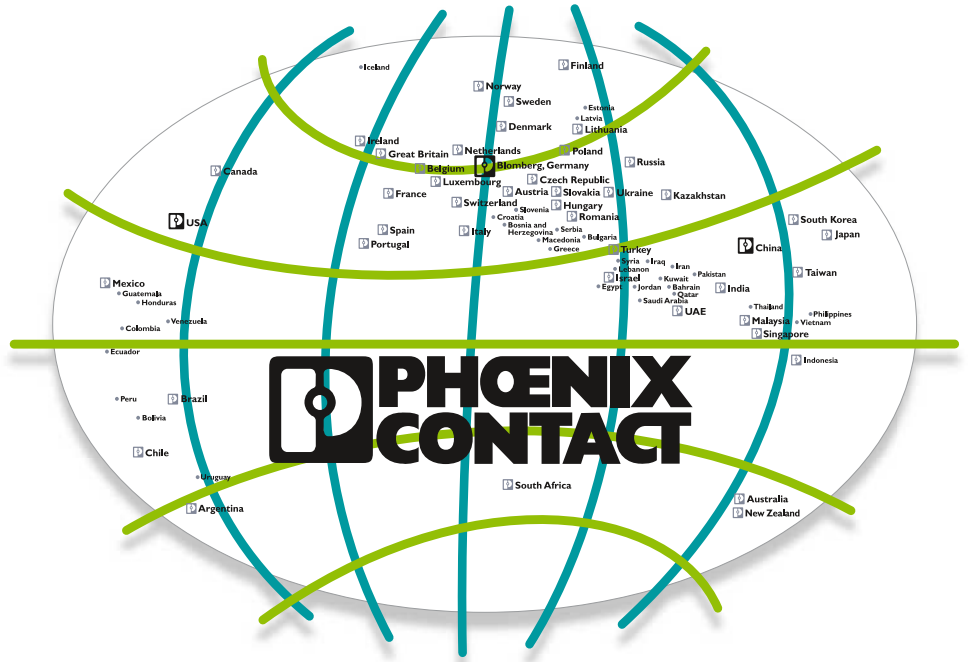

Personal consultation and support

As our customer, you are always the focus of attention at Phoenix Contact, whether during consultation or as part of after sales support. Expert and personal consultation forms the basis of this approach. Even though we live in the age of the Internet, personal interaction with our customers is of great importance to us.

Our team of highly motivated staff are available to you at locations around the world.



Reliable delivery service

It goes without saying that our products are delivered reliably and on time. In addition to our optimized delivery service, we offer numerous options for making the purchasing process more efficient and transparent.

With warehouses in key industrial locations throughout the world, we ensure that you receive your products from Phoenix Contact cost-effectively and within the required delivery time.

Online catalog

The online catalog provides comprehensive, up-to-date information in 7 languages for more than 22,000 products from Phoenix Contact. Here you can find product-specific information such as technical data, notes on approvals, dimensional drawings, 3D data, etc. At the click of the mouse, you can easily generate a product data sheet in PDF format.

In over 15 countries, e-shop functions complete the online catalog. Following successful registration, you can therefore access your prices and delivery schedules at any time and you also have the option of placing orders directly online.

www.phoenixcontact.net/products

Online search assistants

Online search assistants help you to search systematically and quickly for products from our extensive range of plug-in connectors. By selecting electrical values and other product properties, you are taken directly to the products that meet your requirements.

- COMBICON select
PCB connection and electronics housing
- PLUSCON field select
Sensor/actuator cabling
- PLUSCON data select
Data plug-in connectors for fieldbuses and networks



Quickly find product-specific information in the online catalog

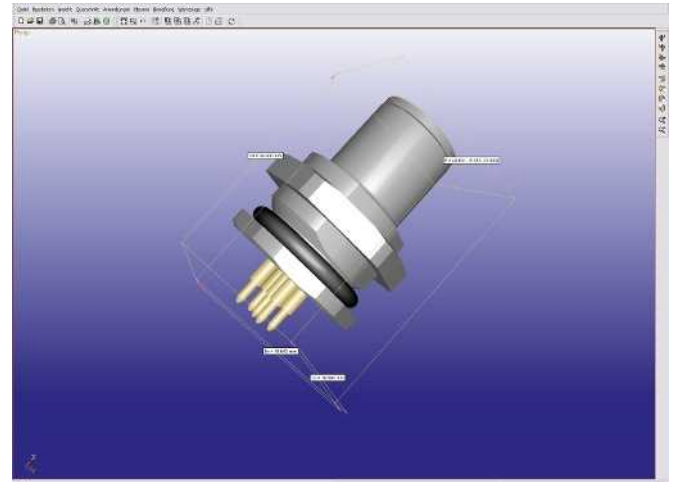

Easy download of 3D data

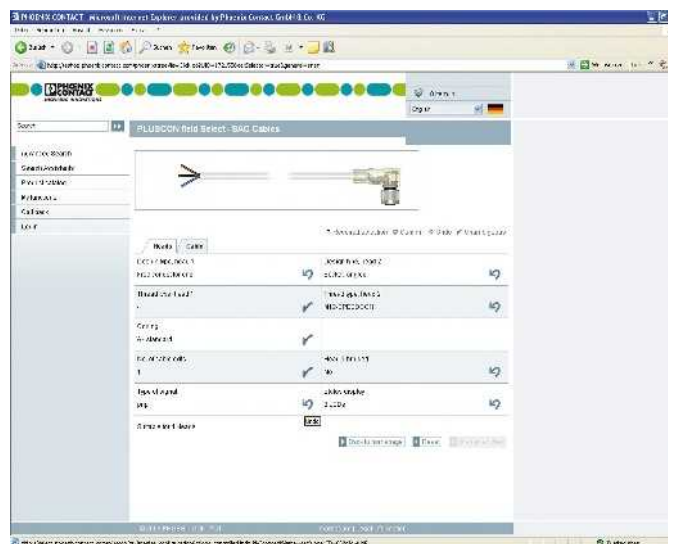

User-friendly product search with PLUSCON field select

Fast connection technology from Phoenix Contact

QUICKON - proven fast connection technology

The secret behind QUICKON at Phoenix Contact is the tried-and-tested IDC connection technology. The term "IDC" stands for Insulation Displacement Connection - a form of insulation displacement contacting.

The key advantage is the lack of conductor preparation, which can save 60 - 80% of the usual connection time compared to spring-cage or screw connections.

In the field of automotive engineering, telecommunications, and household appliances, this type of fast contacting has been established for many years, but now Phoenix Contact has made it suitable for industrial applications. This includes contacts which can accommodate both solid and stranded conductors, which cover a large range of cross sections, which penetrate various wire insulations, and which function reliably and permanently under harsh industrial conditions.

Advantages of QUICKON

- Time-saving connection
- High degree of reliability thanks to defined contact force
- Can be connected multiple times using standard tools

Individual conductors are simply inserted into the wiring space without preparation and pushed into the IDC terminal block by a screw or lever mechanism. Here the wire insulation is displaced without damaging or weakening the copper litz wires in any impermissible way, and a force-defined and thereby user-independent and gas-tight contact is established. The contact resistance values lie between the values for spring-cage or screw connections.

Notes on IDC fast connection technology

The specified cross section range must be observed.

If the conductors are too thin, the insulation will not be correctly displaced since the contact gap is too large, and if the conductors are too thick, it will either not be possible to connect them at all, or the system may be damaged as a result of excessive wiring forces.

QUICKON connections should not be installed at extremely low or high ambient temperatures.

Furthermore, the specified wire insulation must be observed or approved by Phoenix Contact on request. Extremely hard insulation materials, such as Teflon, or very viscoplastic insulation, such as silicone, can only be wired with IDC contacts specifically designed for this purpose. Solid and stranded conductors make very good contact. In the case of highly stranded Category 6 conductors, the minimum litz wire diameter must be observed.

For geometric reasons, two different types of contact have emerged:

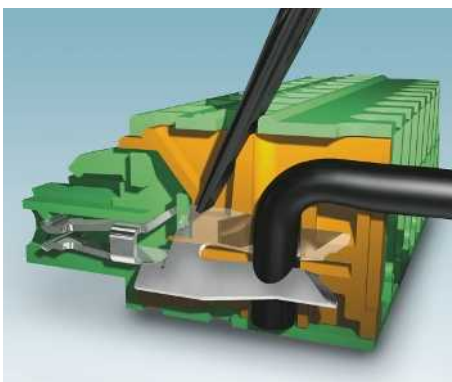

1. Flat contacts are characterized by their space-saving and cost-effective design.



2. Tube contacts cover an even greater cross section range.

Contact resistance

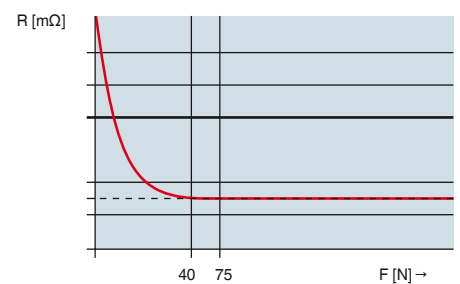

Contact force

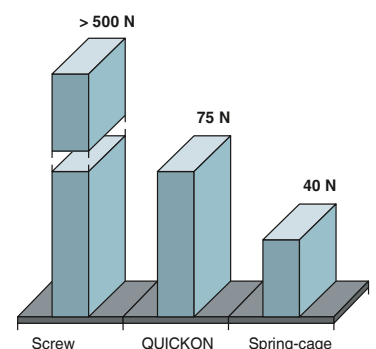

The positive properties and strong market acceptance of QUICKON have encouraged Phoenix Contact to develop a whole range of different products. This range covers numerous modular terminal blocks, PCB plugs, industrial plug-in connectors, and various customer-specific integrations within a cross section range from 0.14 mm² to 6.0 mm².



Heavy-duty plug-in connectors



Sensor/actuator boxes

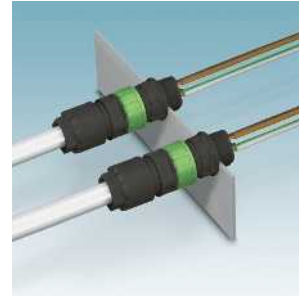

Power distributors



M8 and M12 plug-in connectors



Time savings with QUICKON fast connection

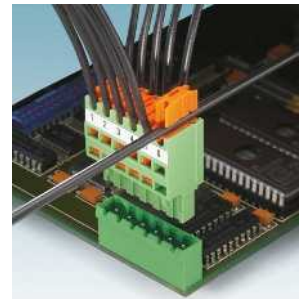

PCB plug-in connectors



Modular terminal blocks



A series plug-in connectors



Special solutions



T-distributors



RJ45 plug-in connectors

Rapid interlock system from Phoenix Contact



SPEEDCON is the logical development of the M12 plug-in connector system that has been established and accepted for many years. Following the principle of “Plug & Turn”, the connection time for M12 plug-in connectors is reduced by 90%.

The SPEEDCON rapid interlock system is 100% compatible with all M12 connections available on the market. It goes without saying that the SPEEDCON plug-in connectors meet all accepted standards and requirements for current M12 plug-in connector systems.

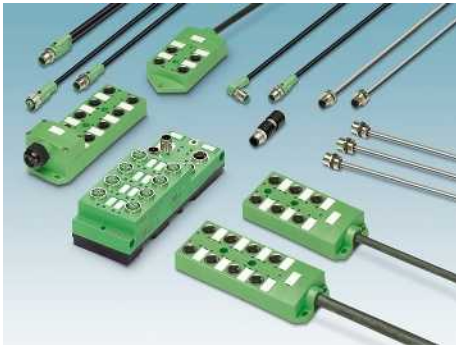

Complete product range

The following pages contain a complete range of SPEEDCON products, consisting of molded cables, plug-in connectors for assembly, flush-type plug-in connectors, adapters, and passive distributor boxes. I/O modules with SPEEDCON connection can be found in the AUTOMATION catalog.

SPEEDCON system partners

A number of well-known and international companies have been won over by the advantages and benefits of the SPEEDCON rapid interlock system and are now fully reliant on the new standard in the M12 world.

Amphenol

BERNSTEIN
safe solutions

binder

BIZERBA

CONINVERS
A Company of the Phoenix Contact Group

FANUC

FESTO

INTER CONTROL

LITZE

Leuze electronic

MATROX
IMAGING

menerga
KLIMATECHNOLOGIE

Mercedes-Benz

Miele

NUMATICS

PEPPERL+FUCHS

p-u-s-o-t-r-o-n-i-c

Rexroth
Bosch Group

SCHUBERT

SEW
EURODRIVE

SICK
Sensor Intelligence.
SIEMENS

SVC

TRUMPF

ThyssenKrupp Fahrtreppen
Ein Unternehmen von ThyssenKrupp Elevator
ThyssenKrupp

Your advantages of using the SPEEDCON rapid interlock system

Compatibility

SPEEDCON is 100% compatible with all current M12 plug-in connector systems. The user does not have to learn anything new, since the "Plug & Turn" principle has been retained.

Fast assembly

Just half a turn and SPEEDCON creates a perfect plug-in connection. The assembly time is reduced by 90% as a result.

Safe operation

SPEEDCON has all the electrical and mechanical properties required of conventional M12 plug-in connector systems.



Classic – SPEEDCON



Insert



Temperature



SPEEDCON – Classic



1/2 turn

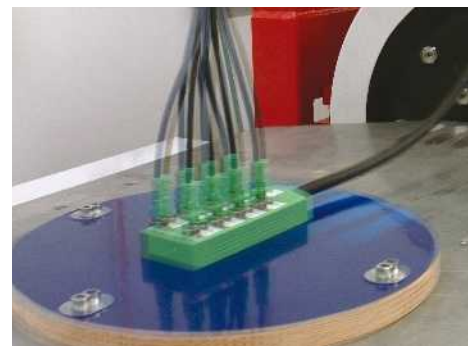

Vibration and shock



SPEEDCON – SPEEDCON



Done!



Noxious gases

DKE

DIN

VDE

IEC

UL US LISTED

UL US

- Pin assignment, requirements, and testing according to **IEC 61076-2-101**
- IP65/IP67/IP69K protection according to EN 60529
- Vibration and shock resistance according to IEC 60512-6d



Screw connection

The screw connection is the most universal and globally accepted conductor connection technology. An important characteristic is the maintenance-free conductor contact. It is not necessary to tighten the terminal screw again. All kinds of copper cables can be clamped without pretreatment, thereby making gas-tight and reliable contact. The wire protector, which protects the individual litz wires from damage, is located between the screw and the conductor. It also performs a screw locking function to prevent release due to vibrations and temperature fluctuations. Splicing protection can be implemented in the form of ferrules. With a screw connection, several wires may also be clamped under one screw. The current-carrying parts of the screw connections are made of high-grade, strain-crack, and corrosion-proof copper alloys.

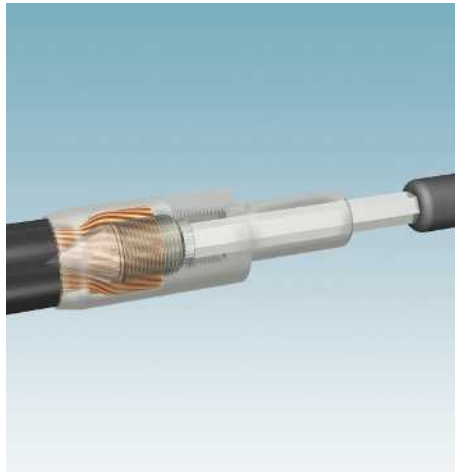

Axial screw connection

With this method, the wire end to be contacted is guided into the connection area of the pin or socket contact. A cone-shaped prong (part of the contact) is then screwed into the stranded wire from the front. The strands of the wire are radially pressed against the contact wall. This results in a gas-tight connection with long-term stability between the wire and contact. It is important that the specified tightening torque is observed. The prong is pressed in using a hexagon key which is applied to the front of the contact. This connection technology combines the advantages of screw and crimp connection. It requires very little space, is easy to execute, and only requires a standard Allen key.

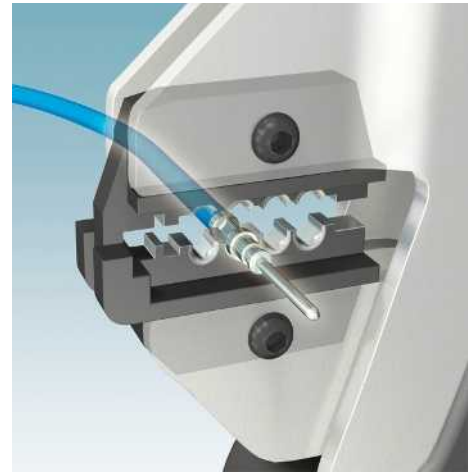

Crimp connection

The crimp connection impresses with its small space requirements and its cost-effective creation in series production. For a reliable connection, it is essential that the conductor cross section, the crimp contact, and the crimping tool are compatible. Furthermore, the crimping process must be monitored during large-scale production as the crimping tools are subject to a certain degree of wear.

Crimp connections can be established with the aid of crimping pliers or crimp machines through specific deformation of the crimping ranges of the contact. The requirements for crimp connections are defined in DIN EN 60352-2. Proof of the quality of a crimp connection can be seen in the tensile strength of the connection and crack-free deformation of the crimp contact. Crimping must not result in impermissible elongation of crimp contacts, as this would prevent them from latching correctly in the contact carrier. The contact is released using a contact removal tool. Assembly tools are also available for very thin conductors.



Spring-cage connection

The spring-cage connection contains a steel spring which pushes the stripped conductor against a power rail. The terminal point is opened with a standard screwdriver. After the conductor has been inserted into the clamping space, the screwdriver is removed and the conductor automatically makes contact. The contact force is independent of the user and a vibration-proof, gas-tight connection with long-term stability is established. The front connection provides an additional advantage. The conductor and screwdriver come in parallel from the same direction and are always within the user's field of vision. Contact inserts can thereby also be connected or re-wired even when mounted. All kinds of copper cables can be clamped without pretreatment, thereby making gas-tight and reliable contact. Splicing protection can also be implemented in the form of a ferrule.

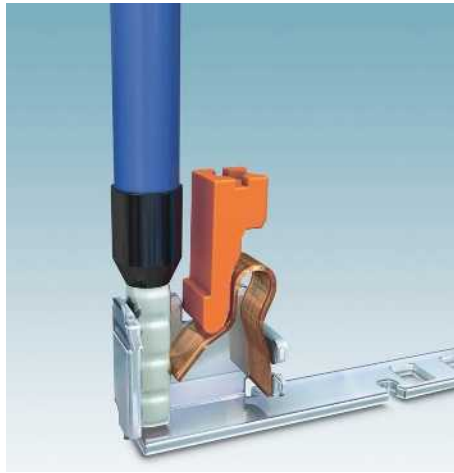

Push-in connection

Stranded conductors with ferrules or solid conductors can be quickly and easily inserted directly into the connection without tools. The contact spring is formed in such a way that it opens automatically when the conductor is pushed in and thereby provides the required pressure force against the current bar for a gas-tight, vibration and shock-proof connection. With the aid of the orange pusher, the terminal block can be opened manually so that conductors with smaller cross sections can also be securely connected. To release the conductor, the orange pusher features a confusion-free and defined operating element. The conductive metals are made from high-grade copper alloys. All metal parts of the connection are made of corrosion-resistant materials.



QUICKON fast connection for single wires

The QUICKON connection is equipped with an IDC insulation displacement contact. The term "IDC" stands for Insulation Displacement Connection. With this connection method, a non-stripped wire with insulation is positioned in front of the gap of the insulation displacement contact and then pushed into the blade gap through insulation displacement. In so doing, the wire insulation is severed and a gas-tight contact is made between the wire and the contact. This can save at least 60% of connection time.

The connection force is independent of the user and completely reliable provided the permitted conductor cross sections and connection conditions are observed. Solid and stranded conductors can be rewired up to 10 times. However, the wire end should be cut off before connecting again.

QUICKON connections have proven themselves in numerous applications for Phoenix Contact over recent years, such as plug-in connectors, for COMBICON, and modular terminal blocks to CEE plug-in equipment from 0.14 to 6.0 mm².

Connection technology for field devices

Product range overview

Circular plug-in connectors – PLUSCON device



Panel mounting plug-in connectors
Page 24



Sleeve plug-in connectors
Page 32



Contact carriers and contacts
Page 38



Screw connections and accessories
Page 42

Data plug-in connectors - PLUSCON data



RJ45 plug-in connectors for Industrial Ethernet with IP20/IP67 protection
Page 78



M12 plug-in connector for Industrial Ethernet
Page 88



Assembled network cables
Page 97



Patch panels, terminal outlets
Page 114



Power plug-in connectors for network cabling
Page 124



Fiber optic network plug-in connectors
Page 126



Assembled fiber optic cables
Page 138



D-SUB-based fieldbus plug-in connectors
Page 184



M12 flush-type plug-in connectors, plugs, and cables for fieldbuses
Page 186



Cable range
Page 194



IP20/IP67 USB plug-in connector
Page 205



D-SUB-based plug-in connectors
Page 185

M5 - M12 circular plug-in connectors - PLUSCON circular



M5 device plug-in connectors
Front mounting Page 224
Rear mounting Page 224



M8 device plug-in connectors
Front mounting Page 225
Rear mounting Page 226



M12 device plug-in connectors with litz wire
Front mounting Page 232
Rear mounting Page 242



M12 device plug-in connectors with square flange
Page 236



M12 device plug-in connectors for PCB mounting, wave soldering processes
Page 246



M12 device plug-in connectors for PCB mounting, THR
Page 256



7/8" device plug-in connectors with litz wire
Front mounting Page 265
Rear mounting Page 266



M12 device plug-in connectors, stainless steel design
Page 268



M8 plug-in connectors for assembly with insulation displacement connection
Page 272



M8 plug-in connectors for assembly with screw and solder connection
Page 273



M12 plug-in connectors for assembly with Piercecon® connection
Page 275



M12 plug-in connectors for assembly with insulation displacement connection
Page 278



M12 plug-in connectors for assembly, screw and spring-cage connection, shielded and unshielded
Page 279



7/8" plug-in connectors for assembly with screw connection
Page 285



M12 power device plug-in connectors
Page 286



M12 power plug-in connectors and cables for assembly
Page 283

M17 - M58 circular plug-in connectors - PLUSCON circular



M17 - signal plug-in connectors
Page 308



M23 - signal plug-in connectors
Page 324



M23 - feedback plug-in connectors
Page 340



M17 - power plug-in connectors
Page 352



M23 - power plug-in connectors
Page 368



M40 - power plug-in connectors
Page 380



M58 - power plug-in connectors
Page 390



Signal/power plug-in connectors,
plastic molded
Page 394



Tools and accessories
Page 404

Photovoltaic plug-in connectors - PLUSCON solar



SUNCLIX panel feed-throughs and DC plug-in connectors
Page 420



SUNCLIX assembled cables
Page 425



SUNCLIX mini - plug-in connectors and module junction boxes
Page 426



Spring-cage terminal blocks for PCB connection
Page 428

Charging plug-in connector systems - PLUSCON power



Combined AC/DC charging system
Page 435



Type 2 charging cables
Page 436



Type 2 and GB sockets
Page 438



GB charging cables
Page 440



Rectangular plug-in connectors

Direct PCB connection and elimination of a panel mounting base – these are some of the outstanding features of the modular, compact, IP67 plug-in connector system.

This range is particularly suitable for use in devices, as well as terminal boxes and control cabinets in harsh industrial environments. Thanks to the modular structure and the numerous contact inserts, from signal to power connections with 70 A, VARIOCON provides proven solutions, particularly in the field of electrical drive technology.

The modular contact inserts with screw and PCB connection form the basis of the range, in addition to fixed contact inserts with crimp connection for turned and rolled contacts. The universal screw connections feature a high degree of reliability, low contact resistance, and a compact design. The contact insert modules are consistently touch proof and can be coded to prevent incorrect connection. The direct PCB connection saves you a complete jumpering level and enables controlled and space-saving device assembly.

Sleeve housing is available in plastic and seawater-resistant die-cast aluminum. The robust screw locking prevents the plug-in connectors from being unintentionally opened and protects them against mechanical disturbances such as shock and vibration.

Note:

VDE 0100/1.97 § 411.1.3.2 and DIN EN 60 204/11.98 § 14.1.3 are applicable when combining several circuits in a cable and/or a plug-in connector.

Product range overview	20
System configuration	22
Panel mounting plug-in connectors	
Panel feed-throughs with screw connection	24
Panel feed-throughs with PCB connection	26
Panel feed-throughs with power crimp connection	28
Supporting base elements with screw connection	30
Sleeve plug-in connectors	
Sleeve frames and contact inserts	32
Sleeve housing	34
Contact carriers and contacts	
Fiber optic contact insert modules with screw connection	36
Contact carriers for turned and rolled crimp contacts	38
Crimp contacts	40
Screw connections and accessories	
Full screw connections	42
Half screw connections	44
Protective covers and adapter plates	48
Accessories	49
Hybrid plug-in connectors	52
Derating diagrams and dimensional drawings	54

Rectangular plug-in connectors

Product range overview



VARIOCON is suitable for use in devices, terminal boxes, and control cabinets.

Thanks to its modular structure and the variety of contact inserts from fiber optics to power connections, the range offers virtually unlimited application possibilities.

The range is based on modular contact inserts with screw and PCB connection, as well as fixed contact inserts with crimp connection for turned and rolled contacts. The variable structure enables the optimum and therefore inexpensive customization of the plug-in connector to suit individual applications.

Housing for direct wall mounting is available in various versions:

Plastic housing made of tough polyamide and aluminum housing with seawater-resistant surface and conductive seal. Together with EMC cable glands, these housings offer outstanding protection against electromagnetic interference fields.

Six good reasons to use VARIOCON device plug-in connectors in industrial applications

The advantages

1. Modularity of the contact inserts and housing

2. No panel mounting base required

3. Robust housing screw locking for startup and servicing

4. COMBICON screw connection technology

5. Direct PCB connection in the device

6. Power crimp connection

Your benefits

- Tailored solution for contact inserts by combining power up to 70 A, signal up to 40 positions, and fiber optics
- Space savings thanks to compact design
- Free choice of housing designs: plastic, metal, and EMC protection

- Reduced assembly time
- IP67 protection with just one housing seal
- Outstanding EMC protection

- Resistant to mechanical disturbances (vibration, shock)
- Protected against unintentional opening of the plug-in connection
- Space savings compared to levers

- High degree of reliability
- Touch-proof
- Low contact resistance
- Compact design
- Can be coded to prevent incorrect connection
- Can be used universally

- Jumpering level eliminated
- Controlled assembly by means of soldering-in
- Space-saving installation

- Easiest means of wall mounting by snapping-in
- Cost-effective as no panel mounting frame or panel mounting flange required
- Controlled factory installation

The product range

Modular contact inserts

VARIOCON Modular enables power and signal transmission to be combined in a single plug-in connector.

The contact system is based on the proven COMBICON connection technology with tension sleeve principle and coding options. The panel mounting side can be supplied with screw connection or alternatively with direct PCB connection.

The connection capacity ranges from 4-pos./70 A/690 V to 40-pos./10 A/160 V. For data transmission, additional fiber optic modules are available.

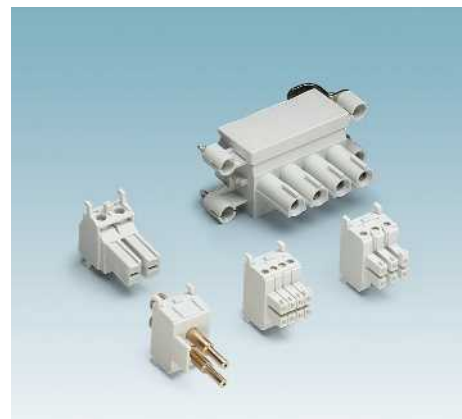

from page 24

Crimp contact carriers

The crimp contact carriers are available as pin or socket contact carriers and meet the requirements for high-position plug-in connections.

Turned and rolled crimp contacts from the proven HEAVYCON D series (EN 175301-801) are available for 15, 30, 50, and 65-pos. crimp contact carriers, plus 2 leading PE connections each.

All the advantages of crimp technology, such as machine pre-assembly or partial assembly, are available with VARIOCON Crimp.



from page 38

Sleeve housing and supporting base elements

Sleeve housing is available in plastic and seawater-resistant die-cast aluminum:

VARIOCON sleeve housing is sealed directly to the mounting panel with two locking screws. This locking method saves space, is easily accessible from above, is vibration-resistant, and meets the requirements of IP65/IP66/IP67 protection (IP68 on request).

Versions with an easy-grip knurled screw are available for tool-free attachment.



from page 31

Accessories

Half cable glands with Pg16 and Pg21 threads are available for VARIOCON housing. Alternatively, housing is also available with M20 and M25 threads.

With the VC adapter plates, VARIOCON plug-in connectors can also be easily used in standard panel cutouts for heavy-duty industrial plug-in connectors.

Protective covers protect the contact inserts when they are not plugged in.



from page 42

Rectangular plug-in connectors

System overview

Modular plug-in connector

The key advantage of VARIOCON plug-in connectors is that a panel mounting base with mounting brackets is not required. The panel mounting plug-in connector is mounted directly on the device panel as a panel feed-through without a panel mounting base. Optional contact inserts with screw connection, crimp connection, and PCB connection are available. The PCB versions are available for parallel (180°) and perpendicular positioning (90°) of the PCB to the housing panel. The sleeve plug-in connector consists of sleeve housing, sleeve contact inserts, and sleeve frame.

Sleeve housing is available in plastic and seawater-resistant die-cast aluminum. The aluminum housings have an electrically conductive seal. In combination with the EMC cable glands, they possess outstanding shield attenuation. The easy and secure mounting principle applies to both the sleeve and housing side. The contact insert modules are snapped into the frame in the desired order and then screwed to the housing or the sleeve.

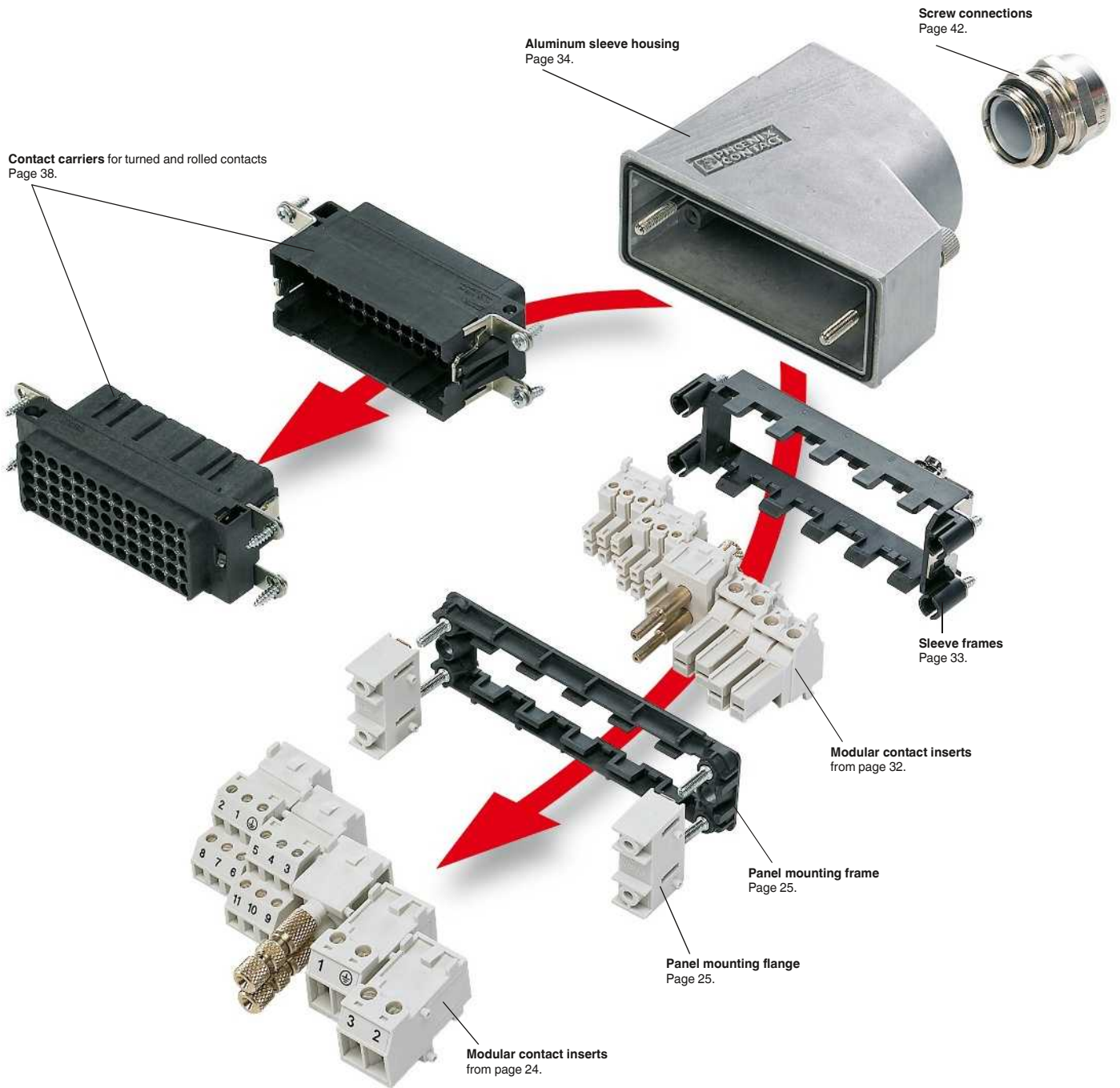

Rectangular plug-in connector configurator

The VARIOCON Select software enables rapid and targeted configuration of modular contact inserts to form a plug-in connector system. The contact inserts are available with different numbers of positions and rated data. They can also be combined in any order. The modularity of the contact inserts and housing allow you to configure tailored combinations of power up to 70 A, signal up to 40 positions, and fiber optics to form a modular plug-in connector. There is a choice of plastic and aluminum housing. In combination with EMC screw connections,

the aluminum housing offers safe protection against electromagnetic interference fields.

